

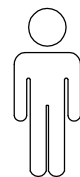

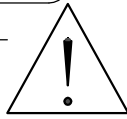

40'

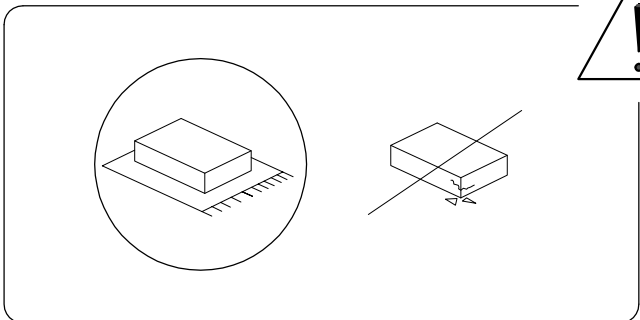
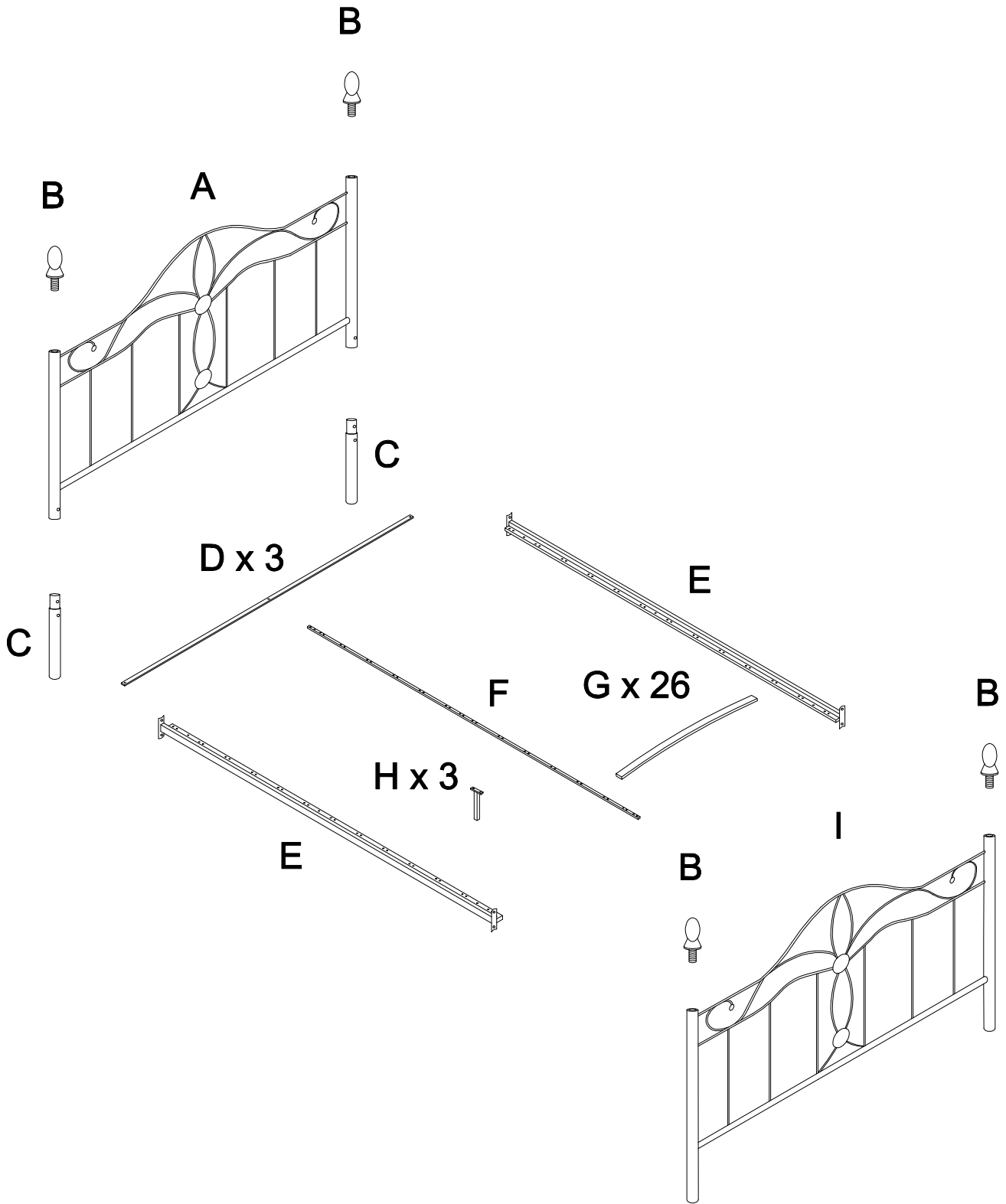
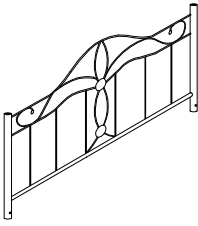

2

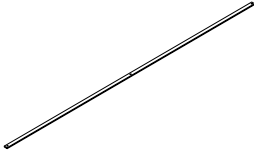
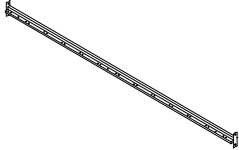

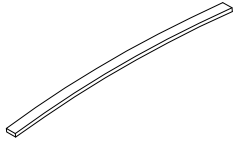
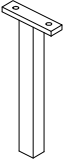
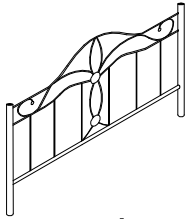
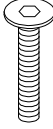
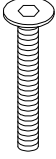
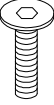
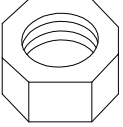
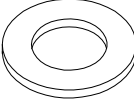
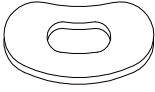
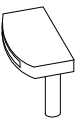
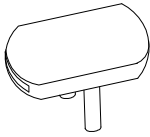
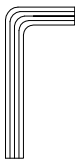
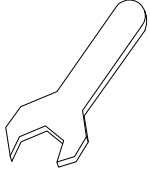
<p>A</p>  <p>x 1</p>	<p>B</p>  <p>x 4</p>	<p>C</p>  <p>x 2</p>	
<p>D</p>  <p>x 3</p>	<p>E</p>  <p>x 2</p>	<p>F</p>  <p>x 1</p>	<p>G</p>  <p>x 26</p>
<p>H</p>  <p>x 3</p>	<p>I</p>  <p>x 1</p>	<p>J</p>  <p>M6 x 45</p> <p>x 3</p>	<p>K</p>  <p>M6 x 60</p> <p>x 9</p>
<p>L</p>  <p>M8 x 20</p> <p>x 8</p>	<p>M</p>  <p>x 12</p>	<p>N</p>  <p>x 6</p>	<p>O</p>  <p>x 8</p>
<p>P</p>  <p>x 26</p>	<p>Q</p>  <p>x 13</p>	<p>R</p>  <p>x 1</p>	<p>S</p>  <p>x 1</p>

1

A

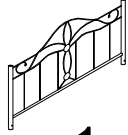

x 1

C



x 2

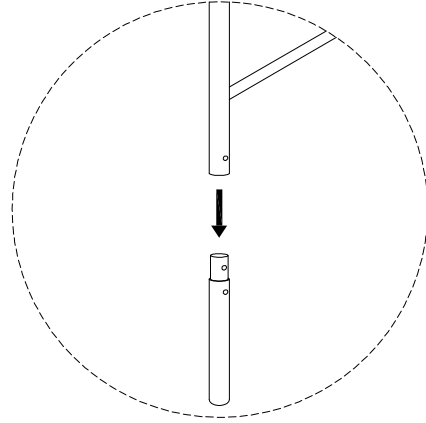
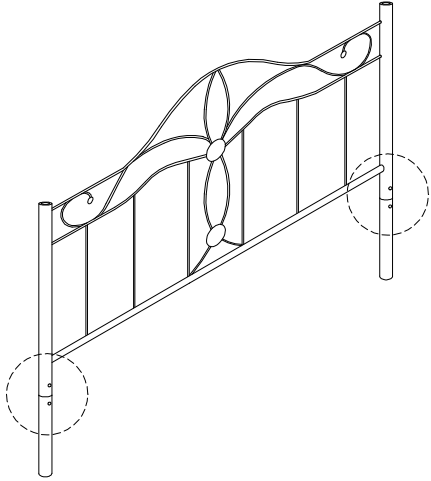

2

E



x 2

O



x 8

L

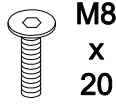

x 8

R

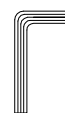

x 1



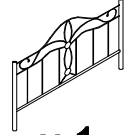

I

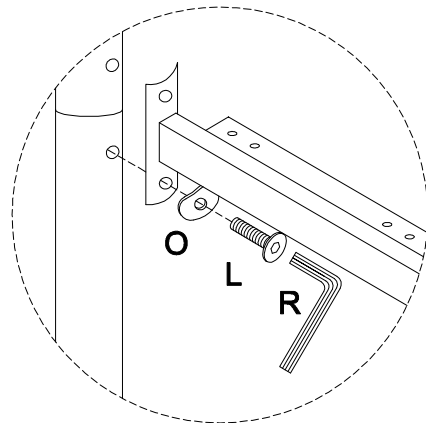
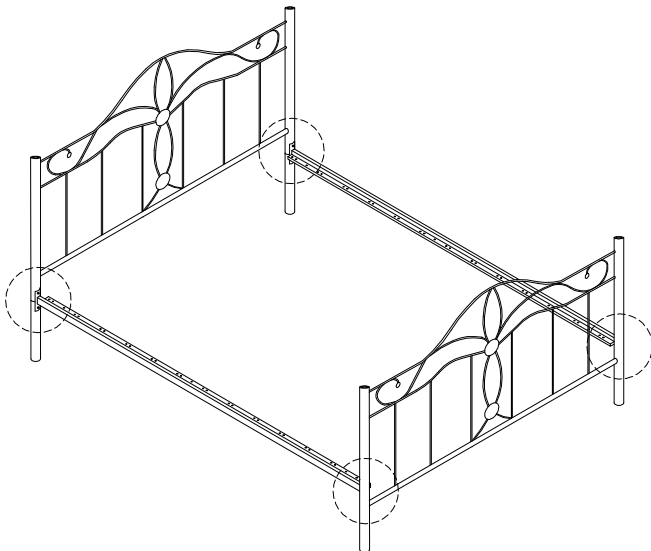

x 1

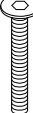

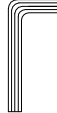



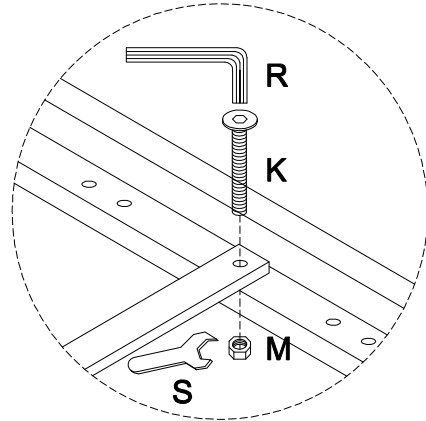
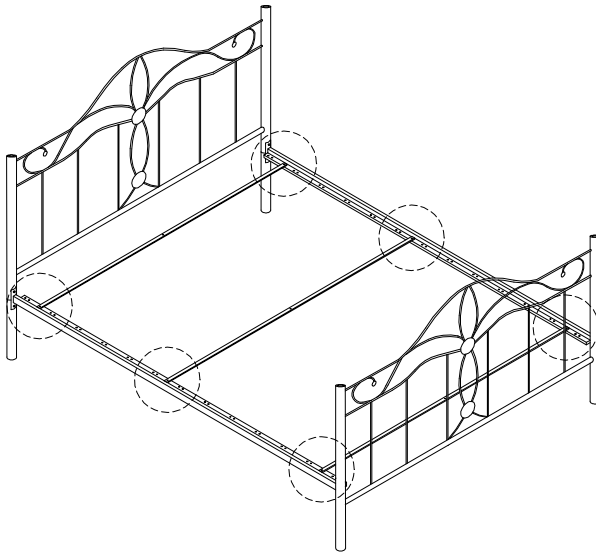

3

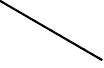
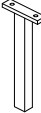
D  x 3	K  M6 x 60 x 6	M  x 6	R  x 1	S  x 1
------------------------------------------------------------------------------------------------------	--------------------------------------------------------------------------------------------------------------------	------------------------------------------------------------------------------------------------------	--------------------------------------------------------------------------------------------------------	--------------------------------------------------------------------------------------------------------

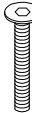

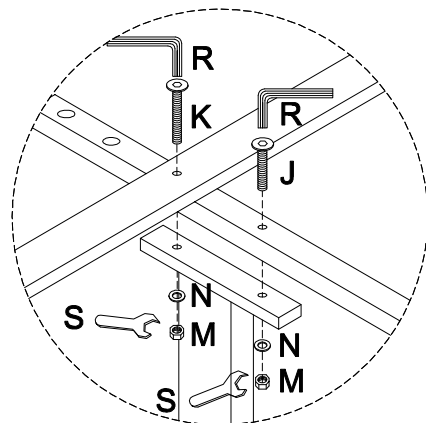
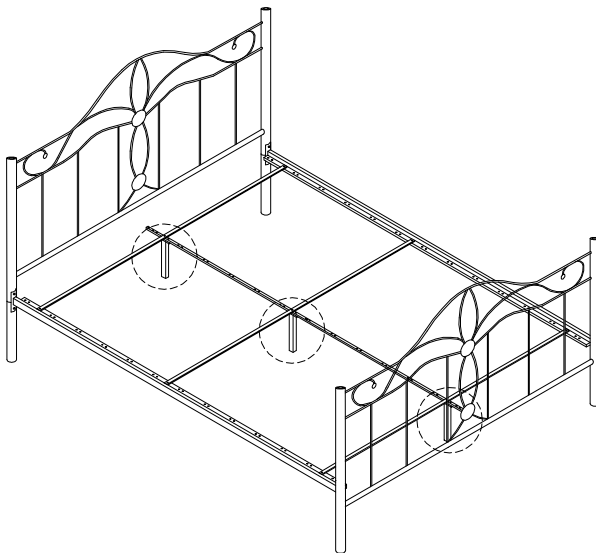

4

F  x 1	H  x 3	J  M6 x 45 x 3	K  M6 x 60 x 3	M  x 6	N  x 6	R  x 1	S  x 1
--------------------------------------------------------------------------------------------------------	--------------------------------------------------------------------------------------------------------	----------------------------------------------------------------------------------------------------------------------	----------------------------------------------------------------------------------------------------------------------	--------------------------------------------------------------------------------------------------------	----------------------------------------------------------------------------------------------------------	----------------------------------------------------------------------------------------------------------	----------------------------------------------------------------------------------------------------------

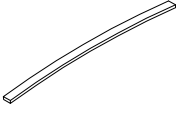

5

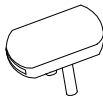
G  x 26	P  x 26	Q  x 13
-------------------------------------------------------------------------------------------------------	-------------------------------------------------------------------------------------------------------	---------------------------------------------------------------------------------------------------------

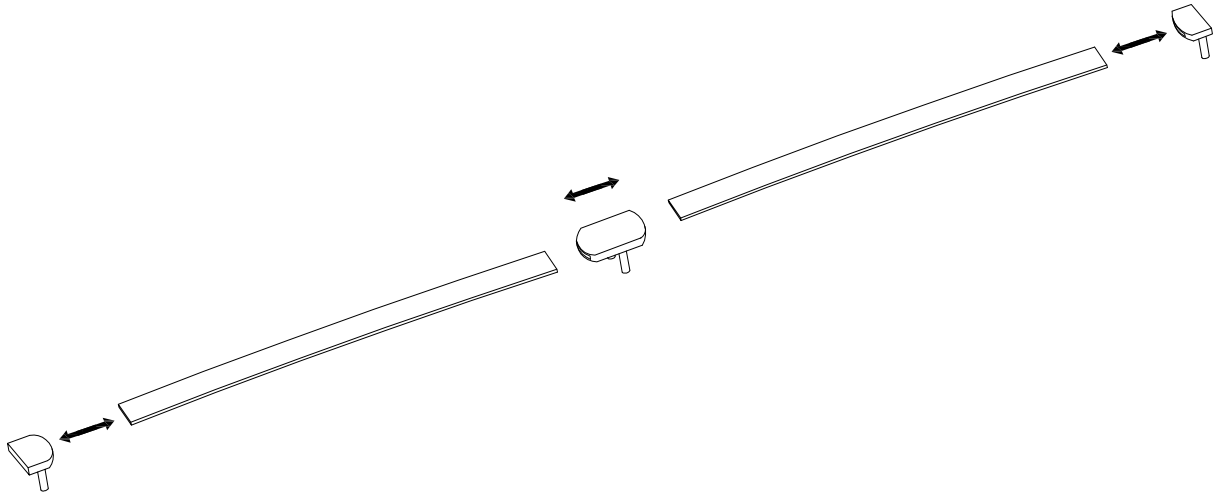

6

B  x 4

