

ASSEMBLY INSTRUCTIONS

CALIFORNIA KING BED

TOOLS REQUIRED



Screwdriver
(Not included)

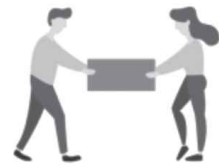

2 - People

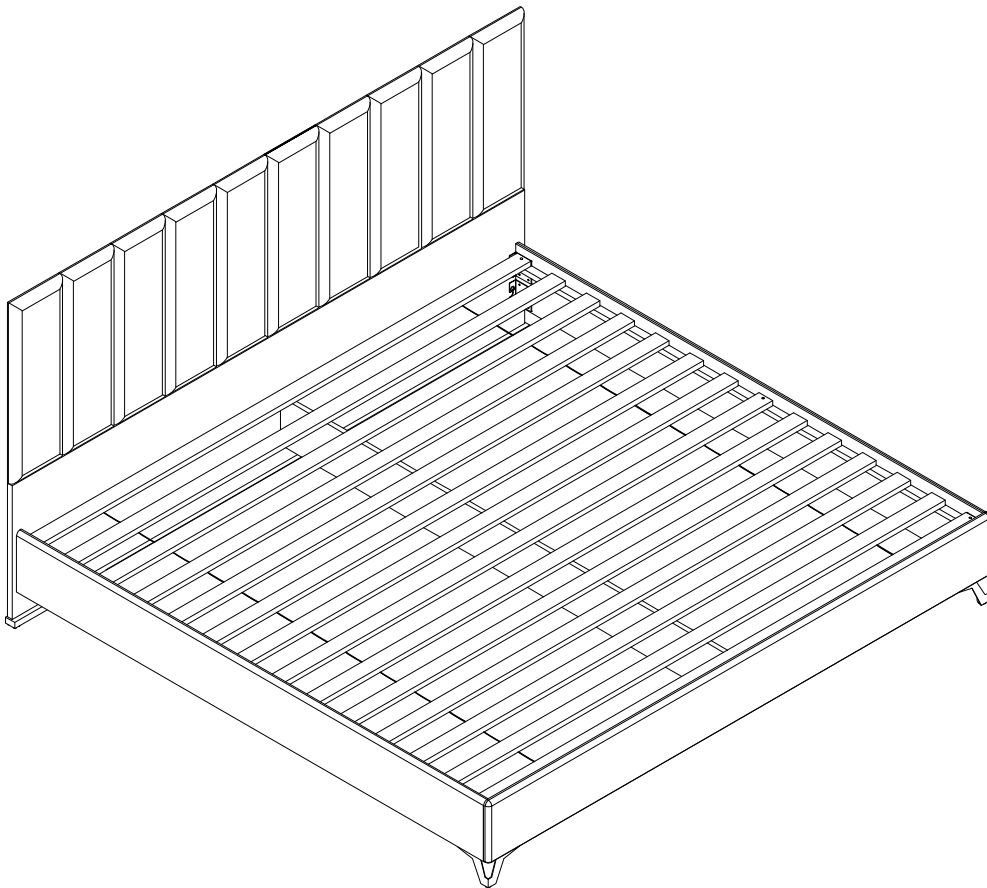

Enjoy this product? We'd love your 5-star review!
If you have any issues, our support team is happy to help.

Thank you for your purchase!

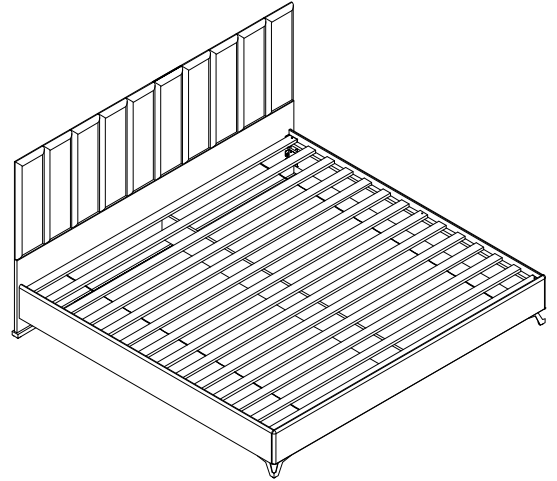

CHECK BEFORE STARTING

Are you missing anything?

Please double check all hardware and parts match the assembly guide before putting the product together. If damaged, we suggest you put the item back in the box and start you claim and return.

Should we send any replacements?

If there are any manufacturer defects or missing pieces please contact us for replacements. If purchased online, please contact the website of where you purchased it from, DIRECTLY.

IMPORTANT INFO before assembly:

- If there's a problem with the parts do not attempt to assemble the product.
- Place all parts on a clean and smooth surface such as a rug/carpet to avoid parts from being scratched.
- When tightening screws to product do not overtighten until product is fully setup.
- If product is too heavy for a single person to carry do not attempt and ask for assistance.
- DO NOT DRAG or PUSH item to desired location. Must be carried when moving.
- If the item is not working as intended please review the assembly guide to see if any steps were missed or incorrectly built. If there's a problem with part please contact seller for additional assistance.
- Please keep all hardware and small parts away from pets/infants
- Please wear gloves or protective gear to protect from getting cuts
- It is normal for new furniture to have an off gassing smell. Please air out furniture near a window or a few hours or a day before placing it in its desired location.
- All products may have a slight color and texture variation due to different shipments, natural materials, screen-resolutions, or lighting in room. Images are rendered by different devices and websites.

CALIFORNIA KING BED

- Please keep instructions for future reference.
- Check the quantity and irregularity of parts and hardware before you start.
- If assembly guide is misplaced, please visit our website for copy.

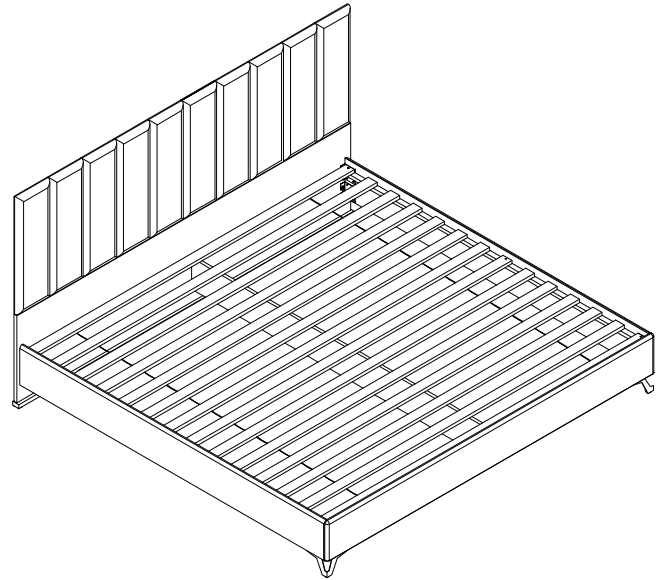

PART LIST

- ① 1pc ② 2pcs ③ 1pc ④ 2pcs ⑤ 1pc ⑥ 1set

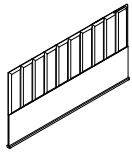

HEADBOARD

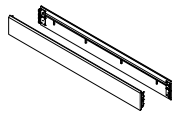

SIDE RAILS

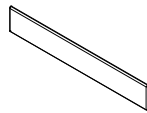

FOOTBOARD

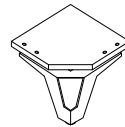

LEG

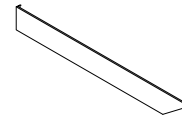

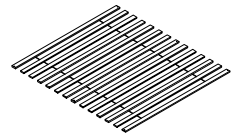

CENTER RAIL



SLATS

HARDWARE LIST

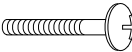
HARDWARE INSIDE FOOTBOARD SIDE RAILS

- Ⓐ 6pcs Ⓑ 8pcs Ⓒ 8pcs Ⓓ 8pcs
-  TRUSS HD C/B M4 X 25MM  JCBC SCREW M6 X 40MM  LOCK WASHER  FLAT WASHER

If any parts/hardware listed are damaged or missing,
Please contact the seller for additional assistance.

ASSEMBLY INSTRUCTIONS

Please loosen the Truss screws on Headboard and Footboard panel.

Please Hook screw plate attached on Side rails and Center rail onto the Truss screws and tighten the Truss screws and secure the Side rails to Headboard and Footboard.

1

- Part ① x1pc
- Part ② x2pcs
- Part ③ x1pc
- Part ⑤ x1pc

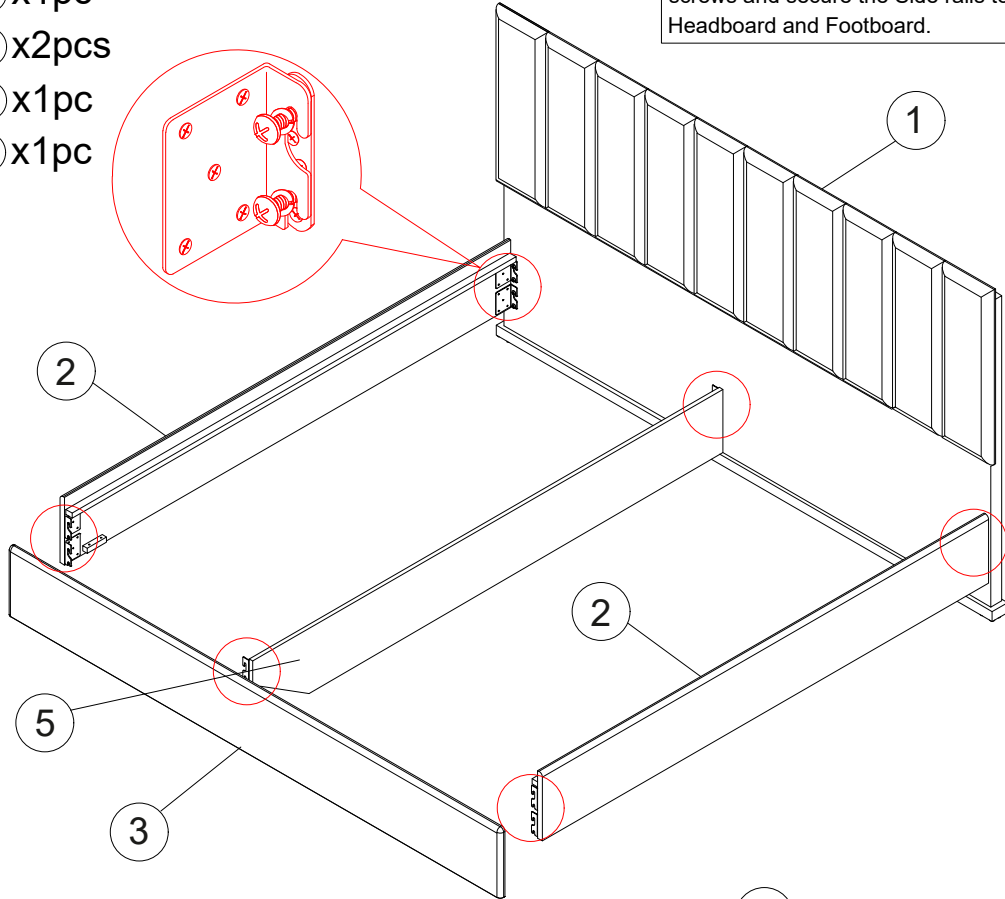

2

- Part ④ x2pcs
- Hardware ⑥ x8pcs
- Hardware ⑦ x8pcs
- Hardware ⑧ x8pcs

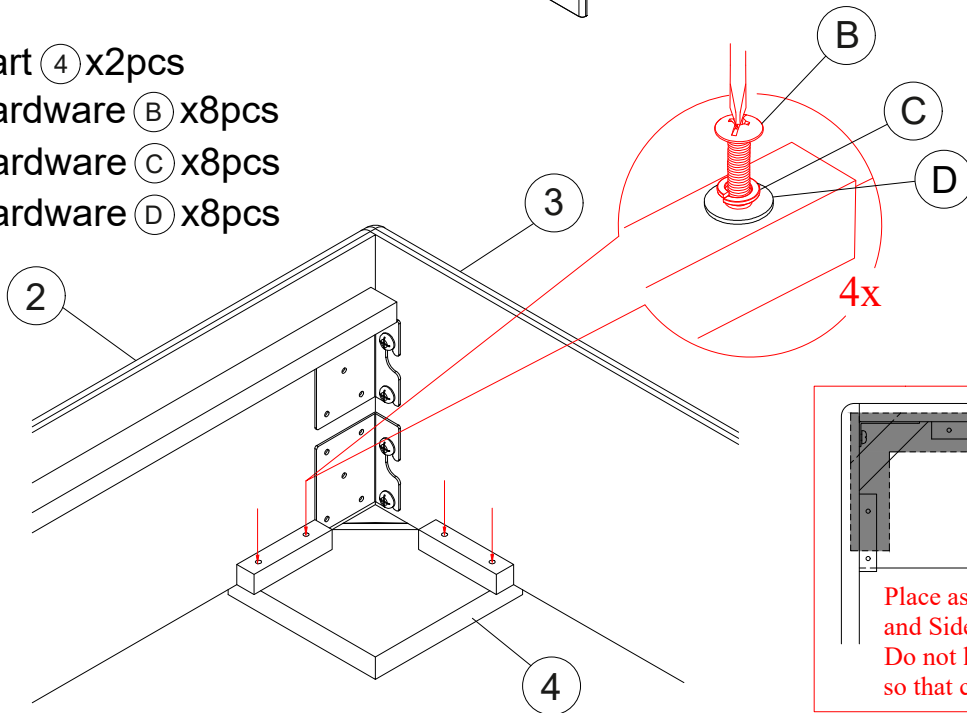

Place assembled Footboard and Siderails above metal leg. Do not lock the bolt too tight, so that can be adjust.

ASSEMBLY INSTRUCTIONS

3

Part ⑥ x1set
Hardware ①A x6pcs

Extend the Slats over Side rails and secure by using Truss HD C/B screw with screwdriver (not included)

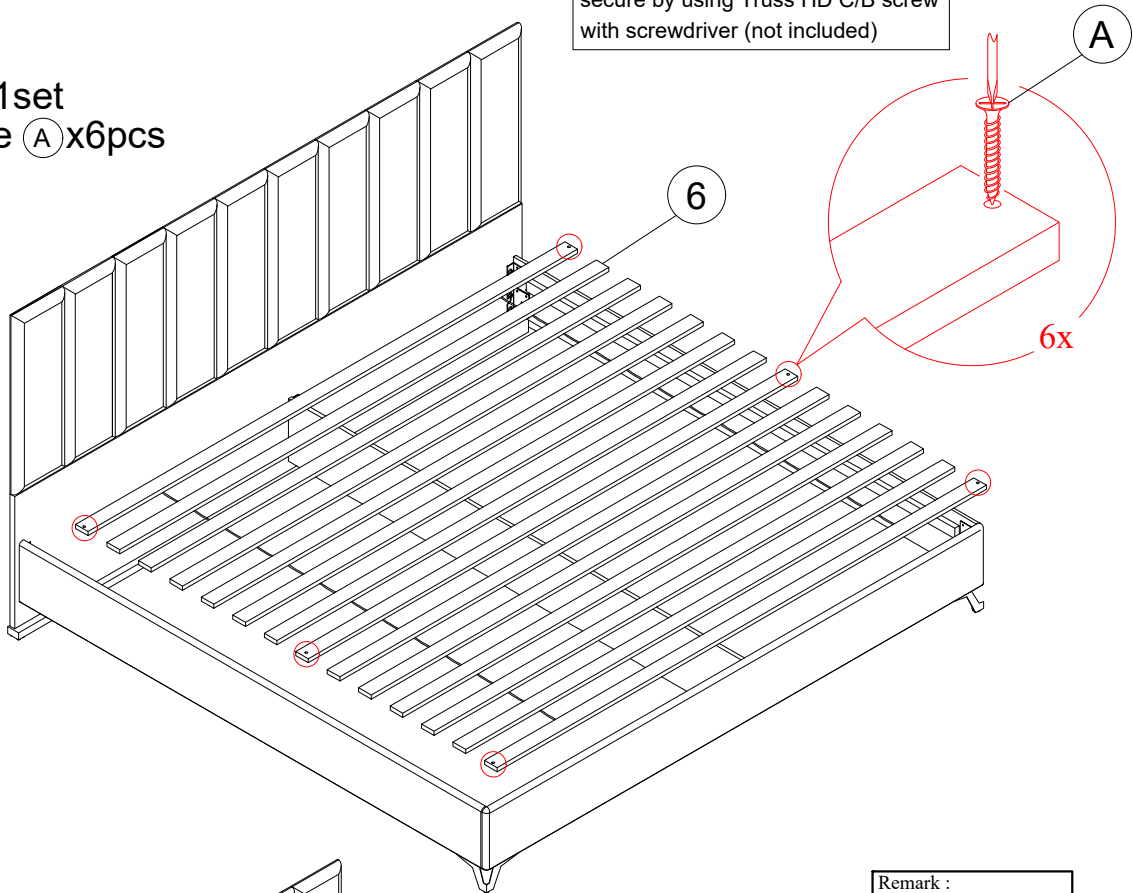

4

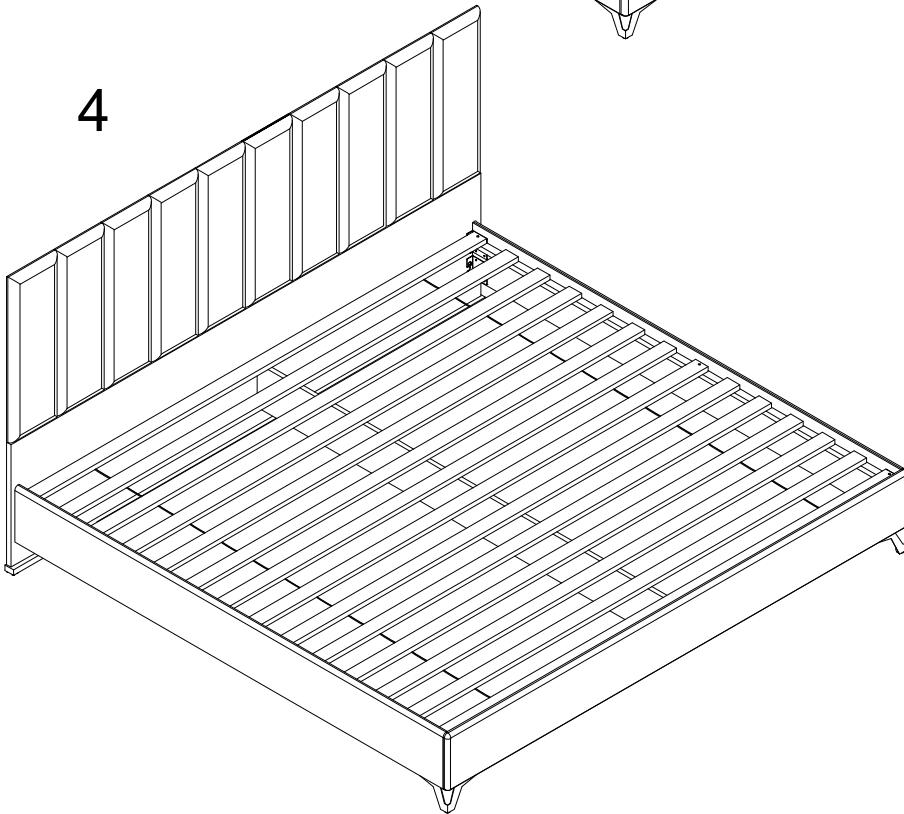

Remark :

Please peel to remove Protection Film

ASSEMBLY COMPLETED



Please ensure the furniture rests on an even and flat surface. If the product wobbles or feels loose, double-check all bolts and/or screws are properly tightened and secured.

✓ Keep this handy!

Please retain this instruction manual and any order-related information for future reference.

✓ Lift, don't drag!

To avoid damage to product please always LIFT the product when transporting or adjusting the placement.

This product is intended for **RESIDENTIAL USE ONLY** and not for commercial use.