

ASSEMBLY INSTRUCTION

INSTRUCTIONS DE MONTAGE

Caution: You must read this before you proceed
Attention: Vous devez lire ceci avant de continuer

(N737P399779/WF324645)

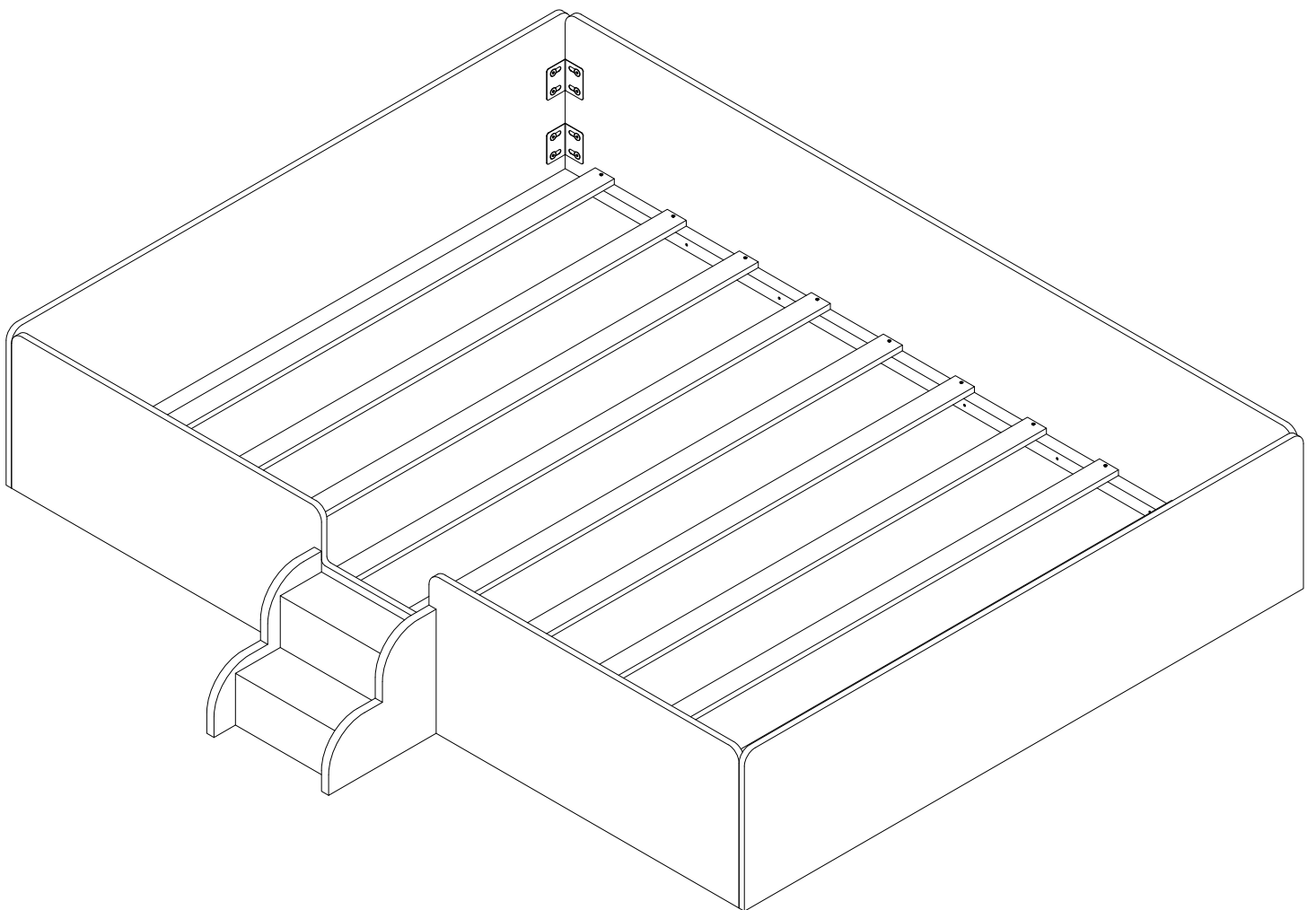

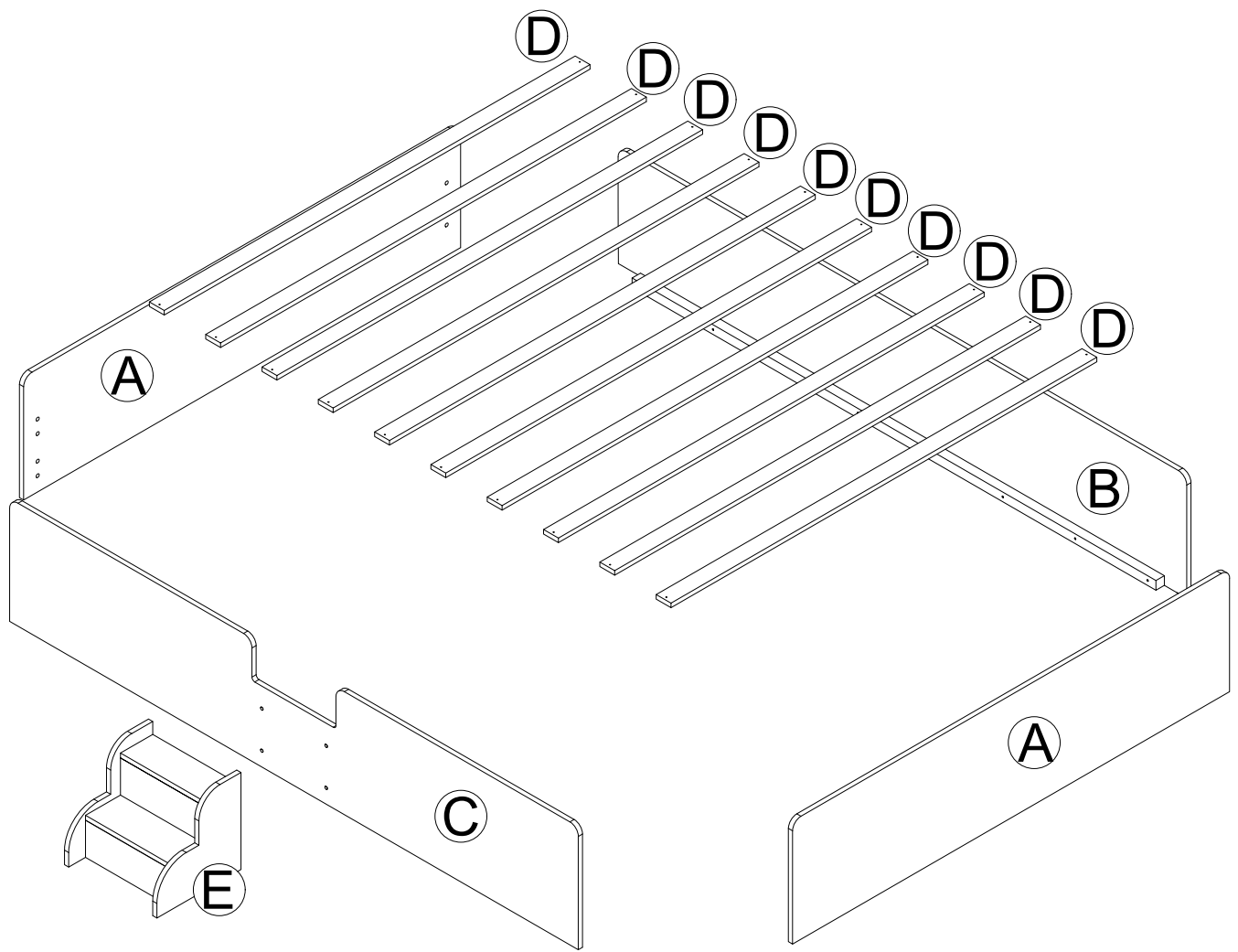

Part List / Liste des pièces(N737P399779)

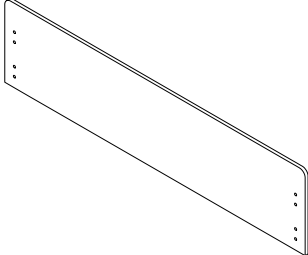
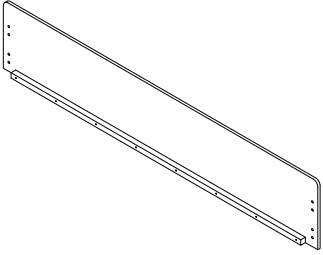
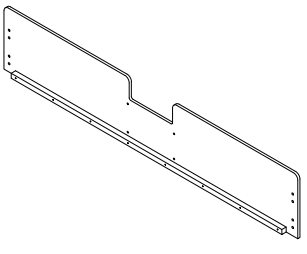
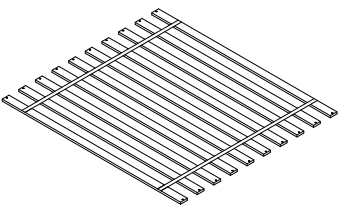
Label/ Étiquette	Picture/ Image	Description	QTY/ Quantité
A		HEADBOARD AND FOOTBOARD / TÊTE DE LIT ET PIED DE LIT	2
B		SIDE PANEL INSIDE/ PANNEAU LATÉRAL À L'INTÉRIEUR	1
C		SIDE PANEL OUTSIDE / PANNEAU LATÉRAL EXTÉRIEUR	1
D		SLAT / LAME	1SET/ 10pcs

Part List / Liste des pièces(WF324645)

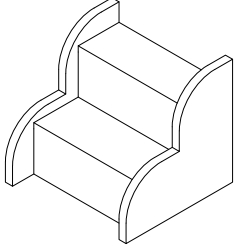
Label/ Étiquette	Picture/ Image	Description	QTY/ Quantité
E		STAIR / ESCALIER	1

Hardware (N737P399779)

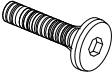
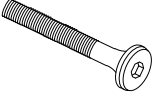
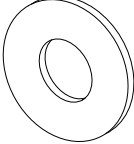
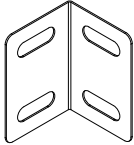
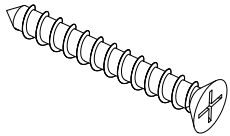
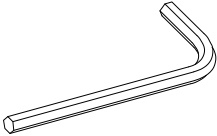
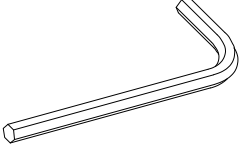
Label/ Étiquette	Picture/ Image	Description	QTY/ Quantité
①		JCBB M8 x 16mm	32
②		JCBC M6 x 35mm	4
③		Flat Washer M6 / Rondelle Plate M6	4
④		BED BRACKET / SUPPORT DE LIT	8
⑤		CSK SCREW M4 x 30mm / VIS CSK M4x30mm	20
⑥		Allen Key M4 / Clé Allen M4	1
⑦		Allen Key M5 / Clé allen M5	1

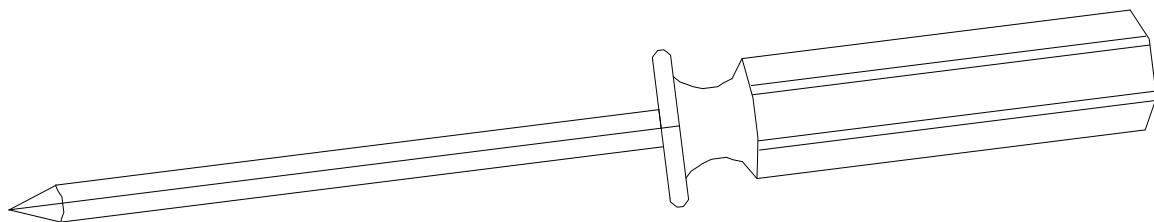

Assembly Tools
Required (Not Included)

Assembly Preparation / Préparation de l'assemblage

Before
Beginning
Assembly

/

Avant de
commencer
l'assemblage

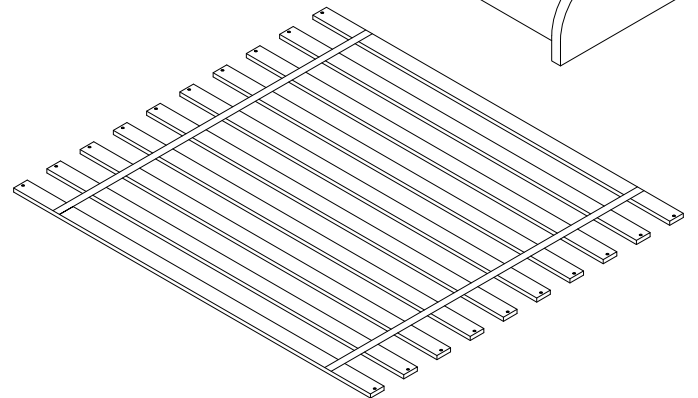
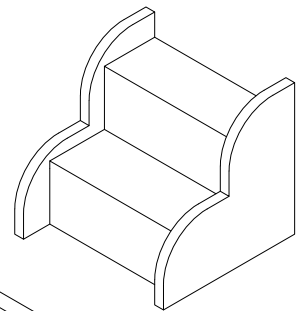
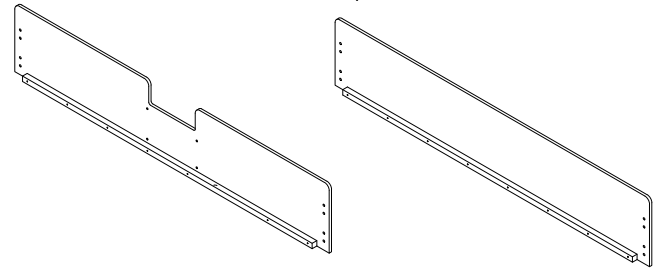
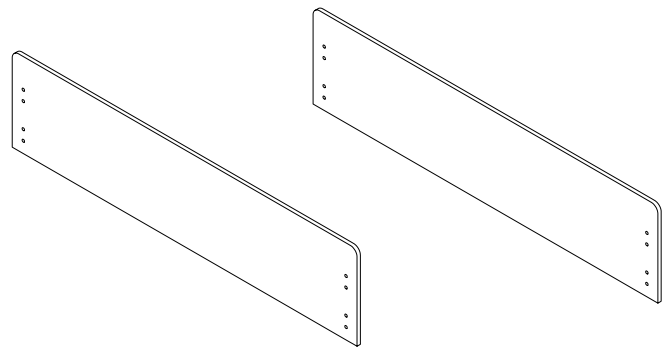
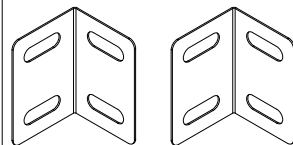
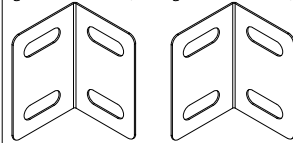
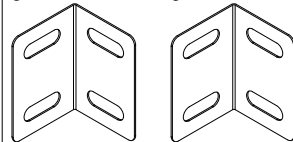
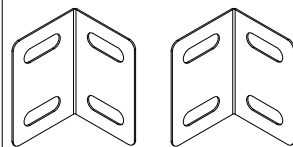
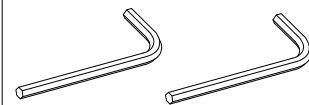
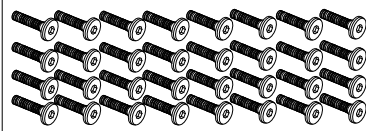

- Read instructions, cover to cover-



- Have 2 adults on hand for assembly-



- Do not assemble on flooring or carpet-



- Assemble on a clean non-marring surface (packing foam)-



- Save all packaging until finished-



- Lire les instructions, de bout en bout



- Avoir 2 adultes à portée de main pour l'assemblage



- Ne pas assembler sur un sol ou un tapis



- Assembler sur une surface propre ne marquant pas (mousse d'emballage)



- Conservez tous les emballages jusqu'à la fin

Assembly Step / Étape d'assemblage

Overview

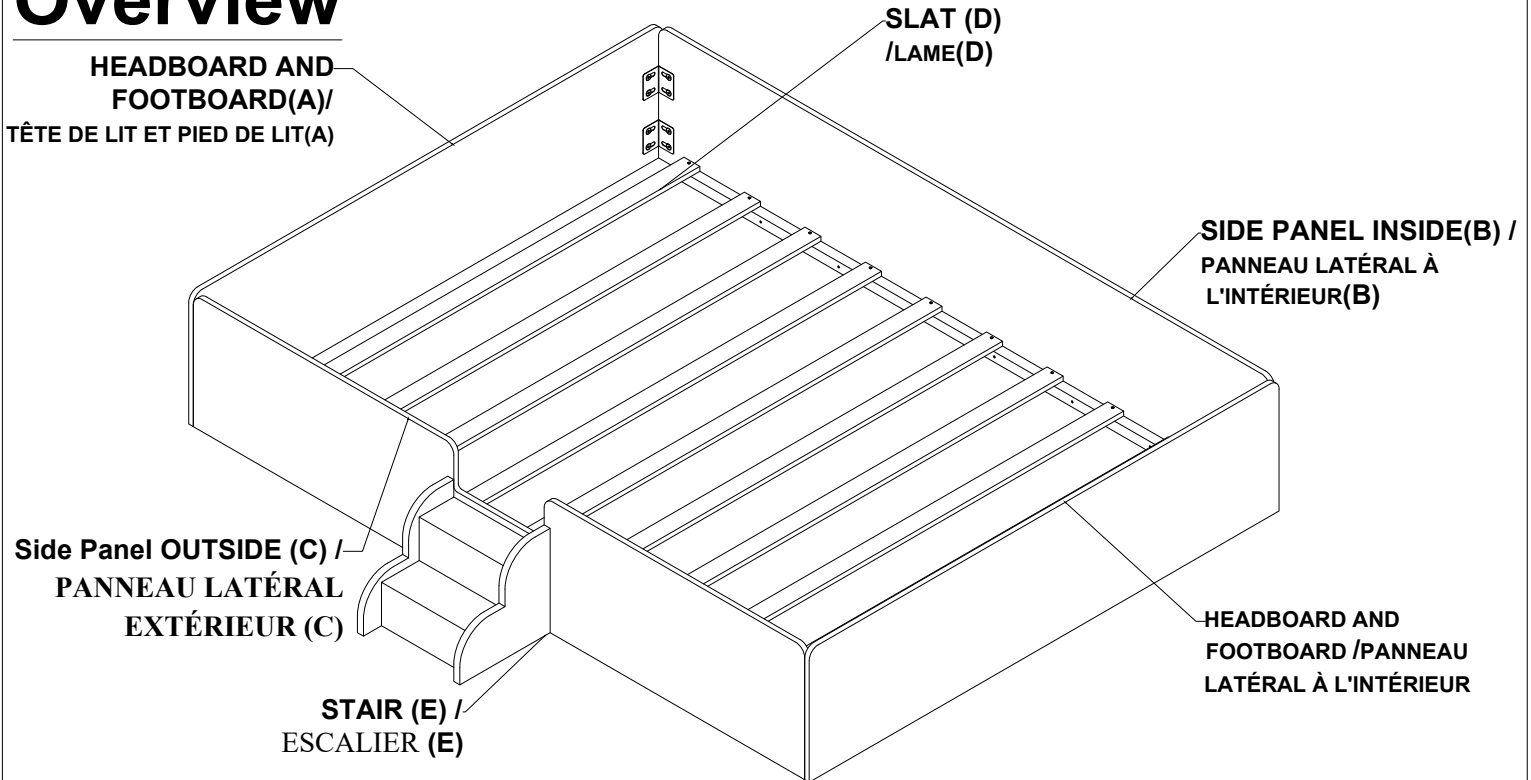

This N737P399779/WF324645 has multiple parts and may require up to 50 minutes to assemble. To give you an overview of the WF324645 parts, the above picture is to help you put the various parts into perspective. Please read through the instructions below to familiarize yourself with the part and steps before assembly.

Ce N737P399779/WF324645 comporte plusieurs pièces et peut nécessiter jusqu'à 50 minutes pour l'assembler. Pour vous donner un aperçu des pièces WF324645, l'image ci-dessus est destinée à vous aider à mettre les différentes pièces en perspective. Veuillez lire les instructions ci-dessous pour vous familiariser avec la pièce et les étapes avant l'assemblage.

Step 1

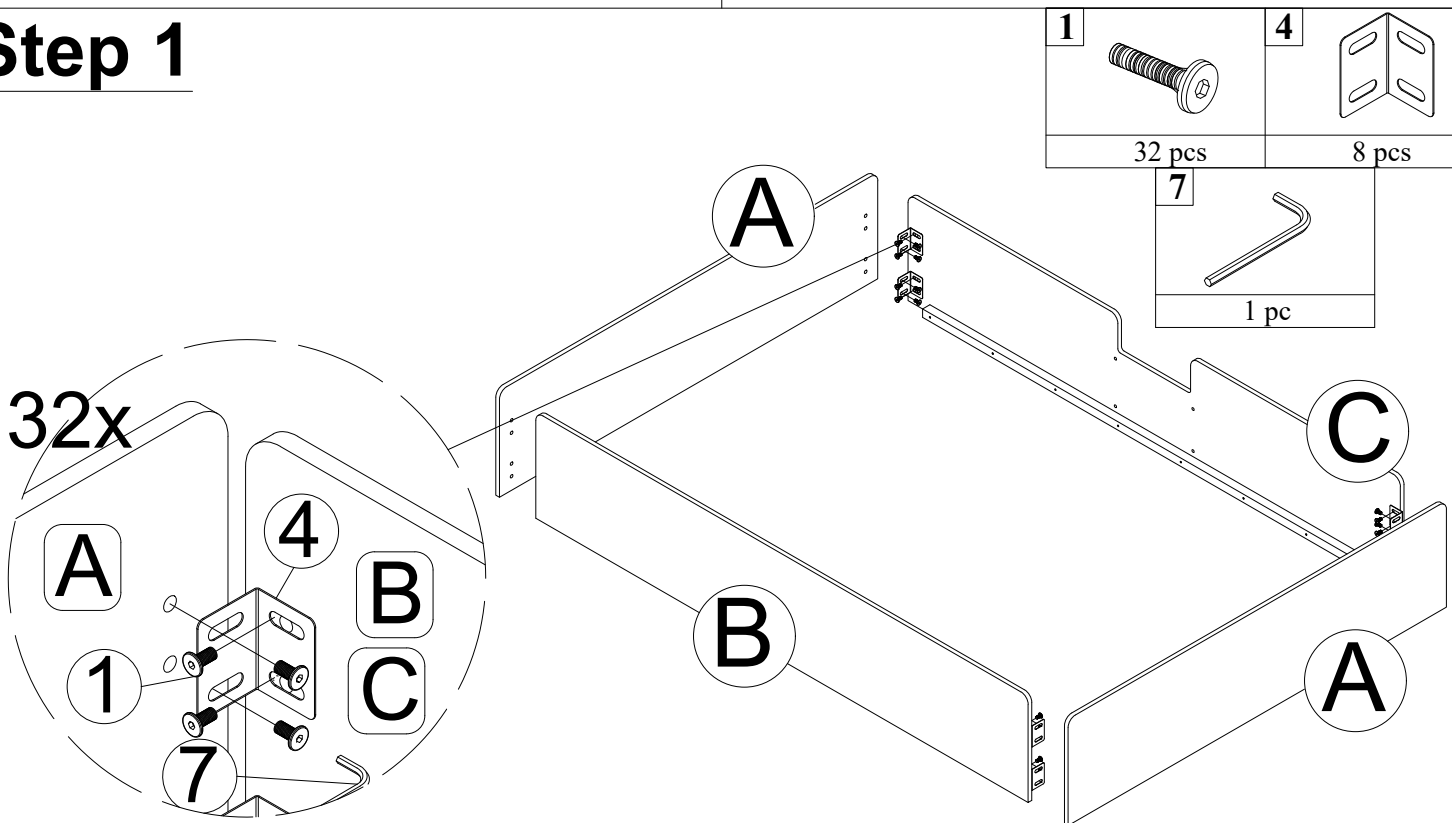

Connect the Headboard (A) to the Side Panel Inside(B) and Side Panel Outside(C) by placing JCBM M8 x 16mm (1)8 pieces and bed bracket (4)2 pieces on every corner and tie up by using the Allen Key (7).
*Tighten by turning the JCBM M8 x 16mm (1) by Allen Key M5 (7) clockwise.

Connectez la tête de lit (A) au panneau latéral intérieur (B) et au panneau latéral extérieur (C) en plaçant 8 pièces JCBM M8 x 16 mm (1) et le support de lit (4) 2 pièces à chaque coin et attachez-les à l'aide du tournevis Allen. Clé (7).
*Serrez en tournant le JCBM M8 x 16 mm (1) à l'aide de la clé Allen M5 (7) dans le sens des aiguilles d'une montre.

Assembly Step / Étape d'assemblage

Step 2

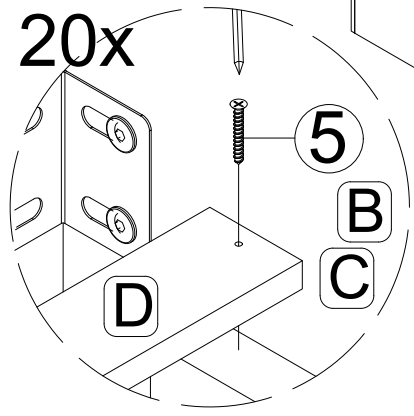
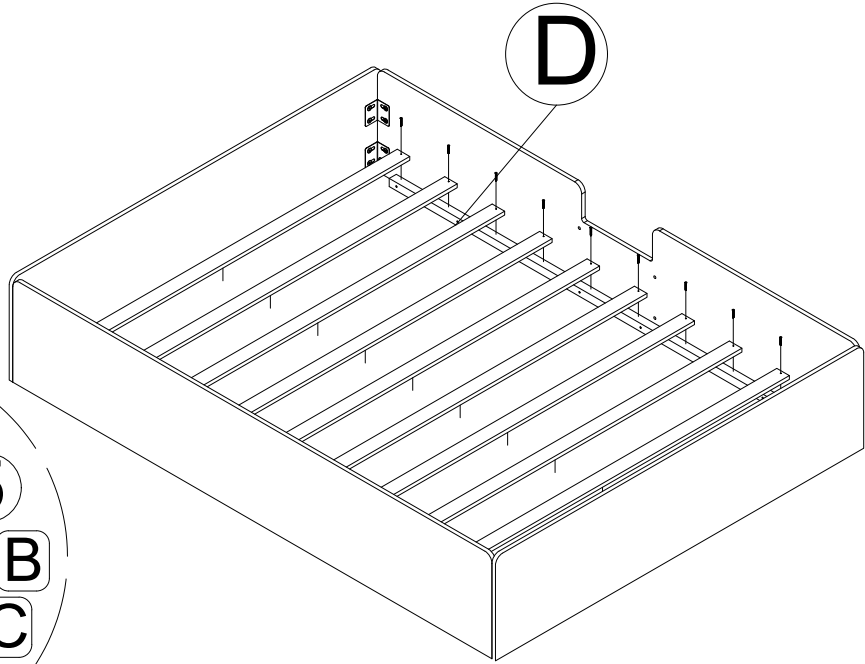
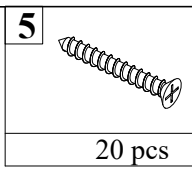

Install the Slat (D) on the base of the side wood already attached to the Inside Panel (B) and Outside Panel (D).
 *Slat position (D) can be fixed by using CSK M4 x 30mm Screws (5) 20 (TWENTY) pieces, each slat(D) uses 2 (TWO)2 pieces.

Installez la latte (D) sur la base du bois latéral déjà fixé au panneau intérieur (B) et au panneau extérieur (D).
 *La position des lattes (D) peut être fixée à l'aide de vis CSK M4 x 30 mm (5) 20 (VINGT) pièces, chaque latte(D) utilise 2 (DEUX)2 pièces.

Step 3

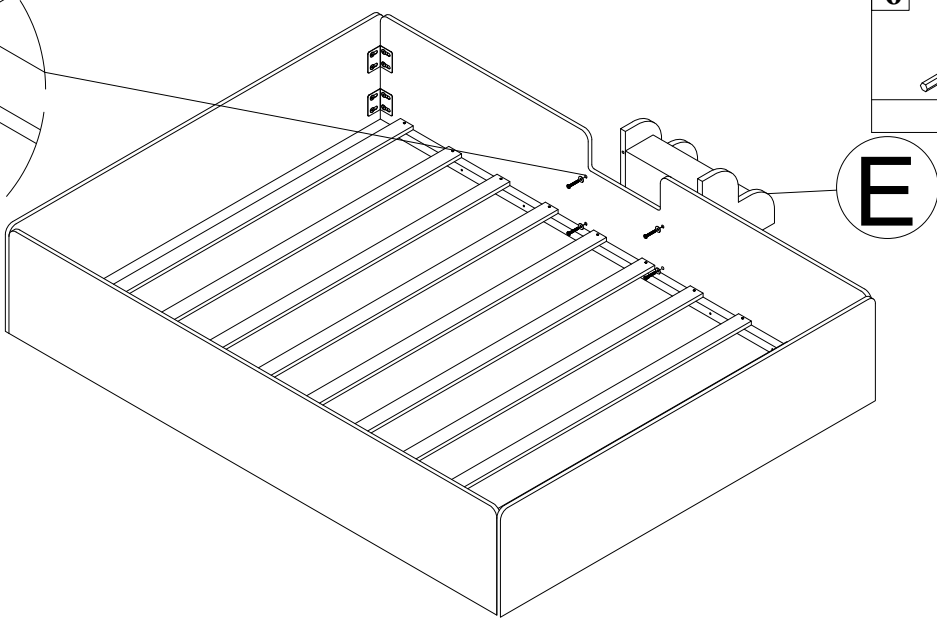
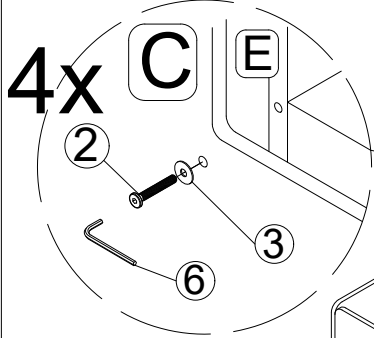
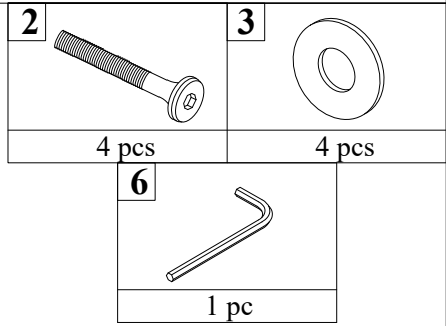

Attach the Stair(E) to the Side Panel Outside (C).
 The Stair position can be set using JCBC M6x30mm(2)4 pieces and flat washer M6(3)4 pieces.
 *Tighten by turning JCBC M6 x 30mm(2) using ALLEN KEY M4(6).

Fixez l'escalier (E) au panneau latéral extérieur (C).
 La position de l'escalier peut être réglée à l'aide de JCBC M6x30mm(2)4 pièces et rondelle plate M6(3)4 pièces.
 *Serrez en tournant JCBC M6 x 30mm(2) à l'aide de la CLÉ ALLEN M4(6).

Step 4

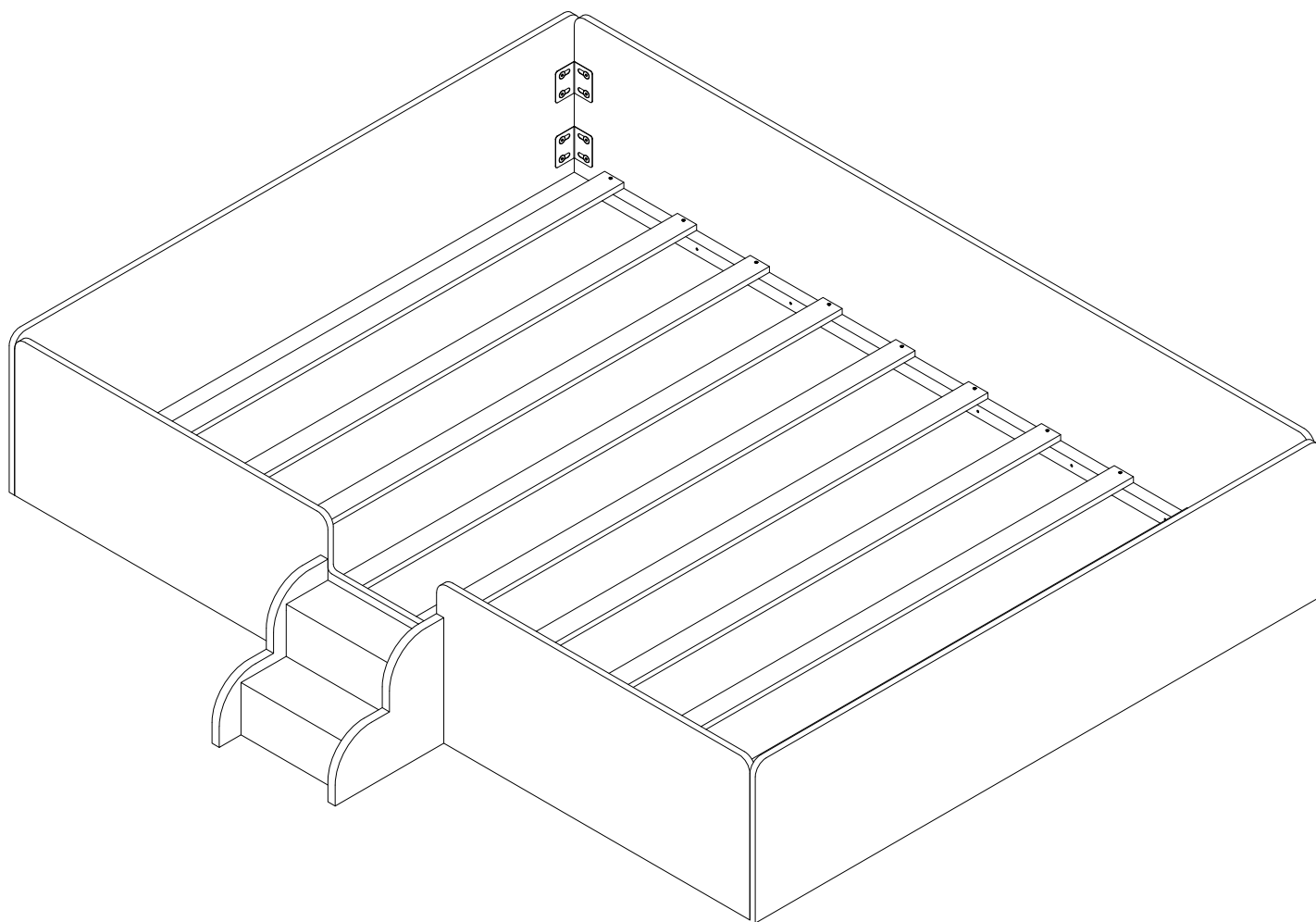

FULLY COMPLETED ASSEMBLY /
ASSEMBLAGE ENTIÈREMENT COMPLÉTÉ

Place the Bed right side up and it is ready for use.
**This N737P399779/WF324645 can only be used on a flat,
level surface.**

Placez le lit à l'endroit et il est prêt à l'emploi.
**Ce N737P399779/WF324645 ne peut être utilisé sur
une surface plane et nivelée.**