

Step 1:

Step 2:

A x 1

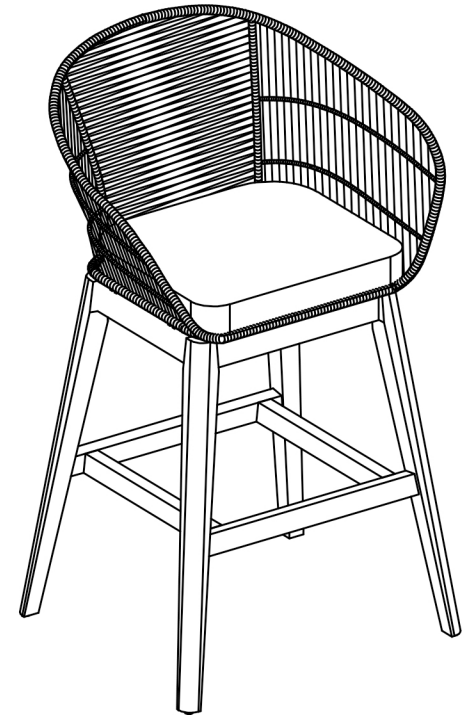
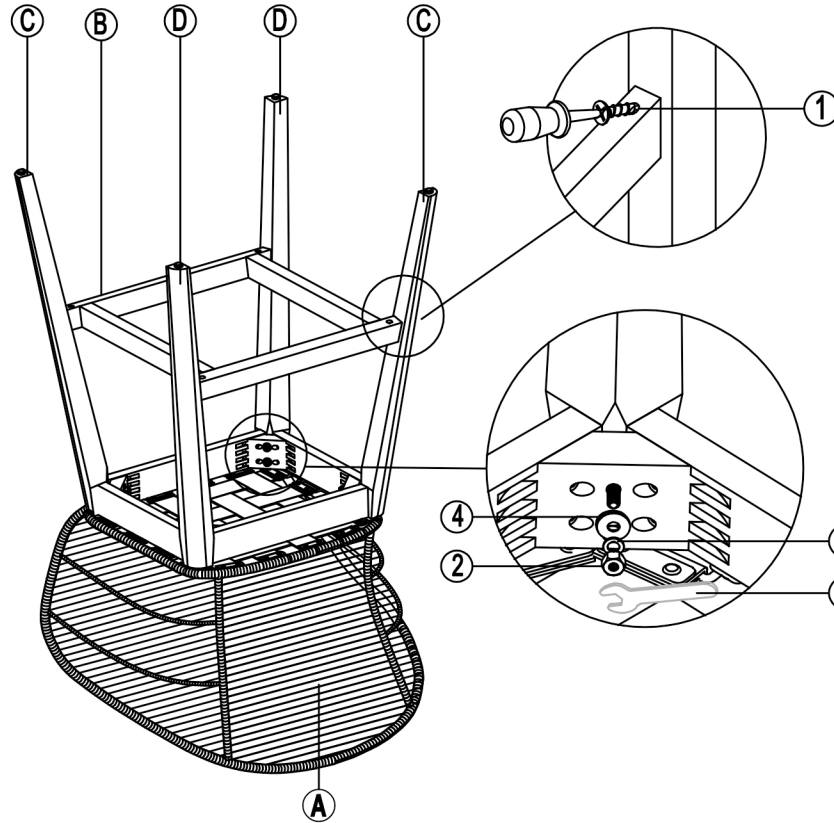
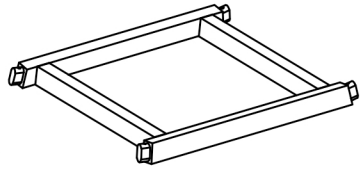

B x 1

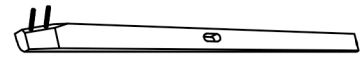





C x 2

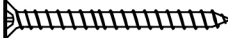

D x 2

LIST OF HARDWARE

No	HARDWARE	QTY.
1	C-Screw 	04
2	Nuts 	08
3	S.S Spring Washer 	08
4	S.S Washer 	08
5	Spanner 	01