

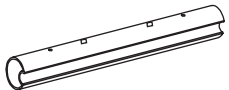









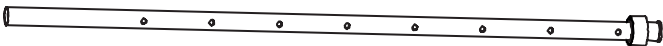

A		x3
B		x2
C		x2
C1		x2
D		x2
E1		x2
E2		x1
F		x1
G		x1
H		x1
I		x2
J		x10
K		x2
L		x2
M		x1
N		x2

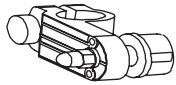
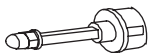
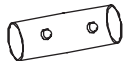

2

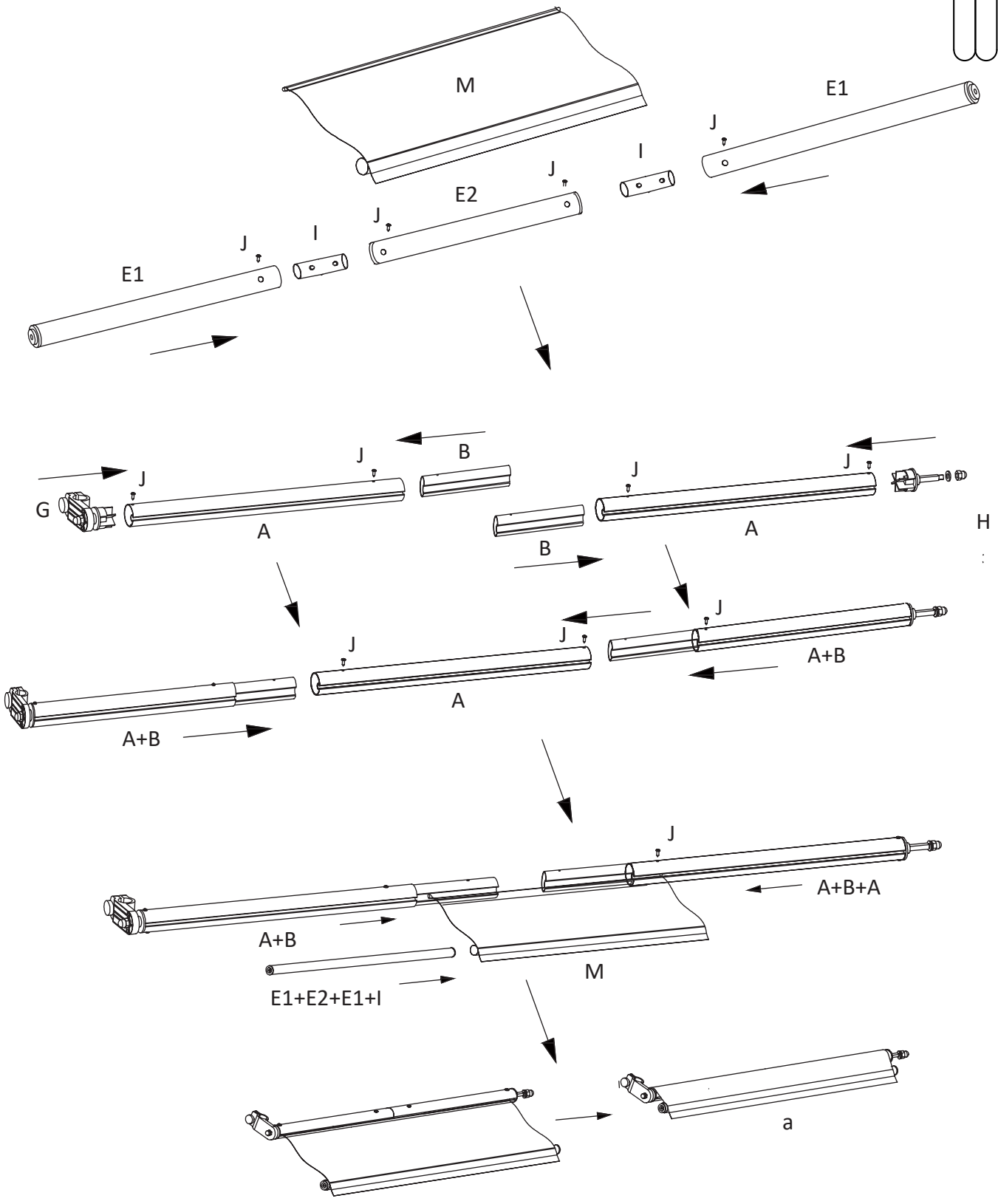
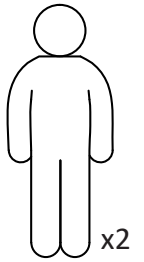
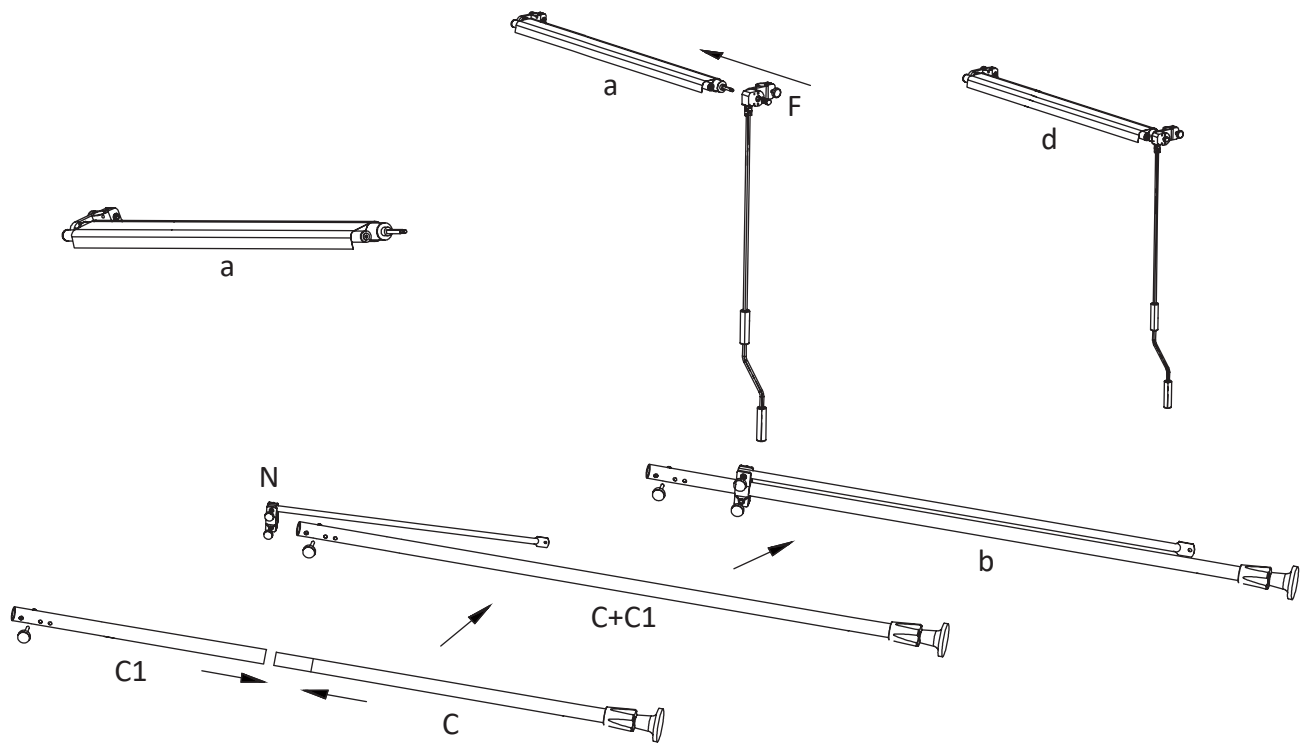

3

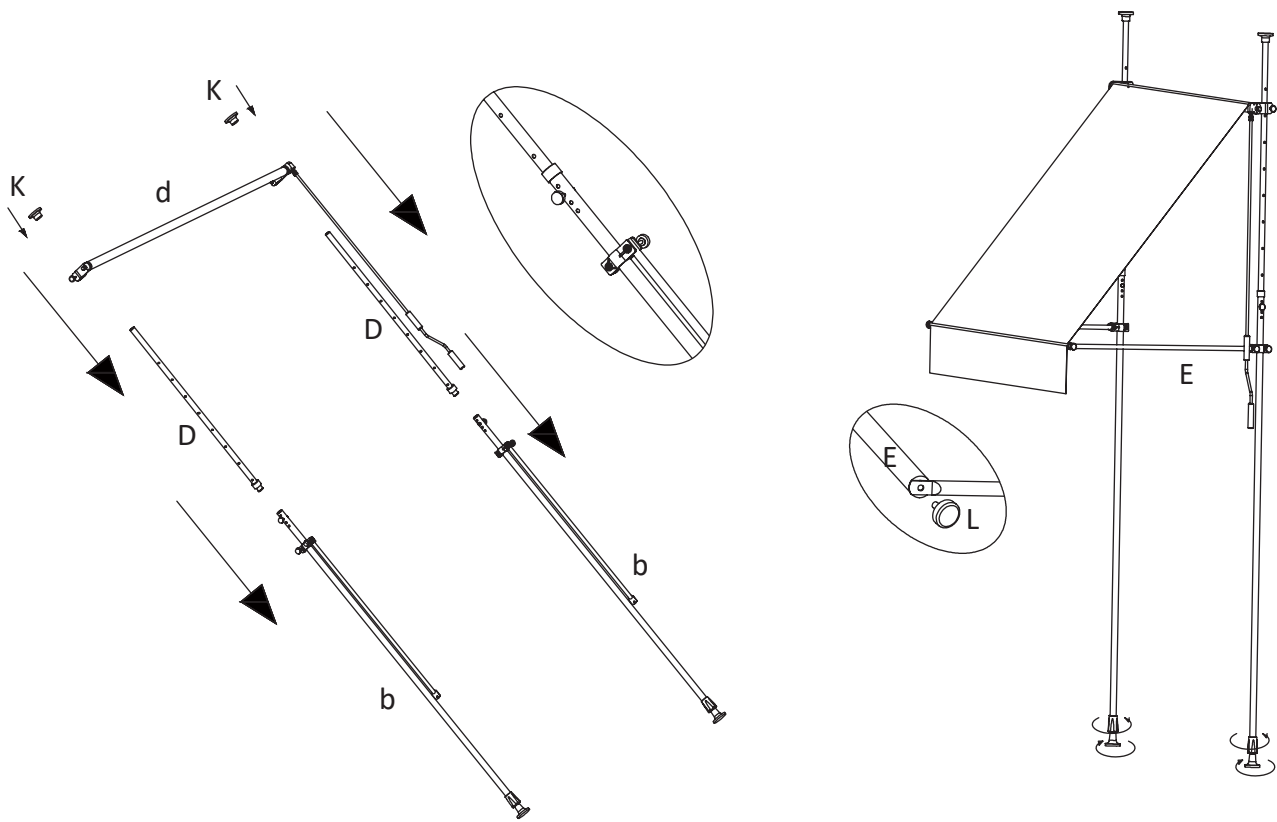

Ax1

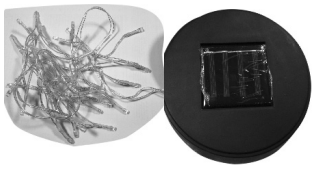

Bx1



Cx1



Dx2



1

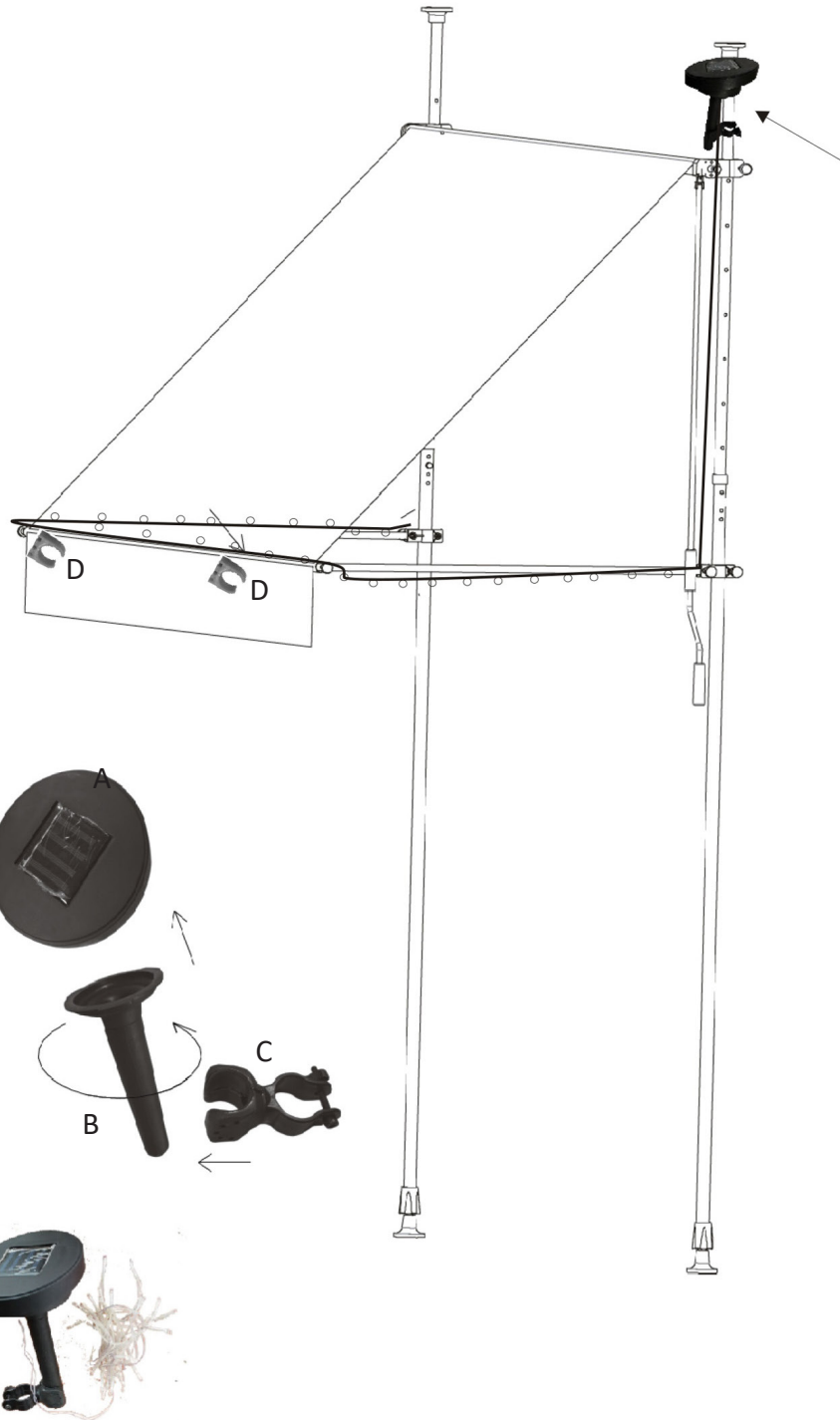

EN	<p>⚠ Warning</p> <ul style="list-style-type: none"> Never install it in high and windy places, as the sunshade may drop and hurt people. 	<ul style="list-style-type: none"> The awning must be retracted if the wind speed reaches higher than 27km/h.
DE	<p>⚠ Hinweis</p> <ul style="list-style-type: none"> Montieren Sie die Markise niemals an hohen, dem Wind ausgesetzten Stellen, da sie herunterfallen und 	<ul style="list-style-type: none"> Passanten verletzen kann. Die Markise muss zurückgezogen werden, wenn die Windgeschwindigkeit höher als 27 km/h ist.
FR	<p>⚠ Avertissement</p> <ul style="list-style-type: none"> Ne jamais l'installer dans un endroit trop élevé et exposé au vent, l'auvent peut tomber et blesser les 	<ul style="list-style-type: none"> gens. L'auvent doit être rabattu si la vitesse du vent dépasse 27km / h.
NL	<p>⚠ Waarschuwing</p> <ul style="list-style-type: none"> Nooit installeren op hoge en winderige plaatsen, aangezien de parasol kan vallen en mensen verwonden. 	<ul style="list-style-type: none"> De luifel moet worden ingetrokken als de windsnelheid hoger is dan 27 km/u.
IT	<p>⚠ Avvertimento</p> <ul style="list-style-type: none"> Non installare la tenda mai in luoghi alti e ventosi, poiché il parasole può cadere e far male le persone. 	<ul style="list-style-type: none"> La tenda deve essere retratta se la velocità del vento supera i 27 km/h.
PL	<p>⚠ Ostrzeżenie</p> <ul style="list-style-type: none"> Nigdy nie instaluj jej w miejscach wysokich i wietrznych, ponieważ osłona przeciwsłoneczna może spaść 	<ul style="list-style-type: none"> i zranić ludzi. Zadaszenie musi zostać zwinięte, jeżeli prędkość wiatru przekracza 27 km/h.
SE	<p>⚠ Varning</p> <ul style="list-style-type: none"> Installera den aldrig på höga och blåsiga platser, eftersom solskyddet kan falla och skada människor. 	<ul style="list-style-type: none"> Markisen måste vara indragen om vindhastigheten överstiger 27km/h.
ES	<p>⚠ Advertencia</p> <ul style="list-style-type: none"> Nunca lo instale en lugares altos y con mucho viento, ya que el toldo puede caer y dañar a la gente. 	<ul style="list-style-type: none"> El toldo debe retirarse si la velocidad del viento supera los 27 km/h.
DK	<p>⚠ Advarsel</p> <ul style="list-style-type: none"> Sæt den aldrig op på høje og blæsende steder, da solskærmen kan falde ned og skade folk. 	<ul style="list-style-type: none"> Solsejlet skal trækkes tilbage, hvis vindhastigheden overstiger 27 km/t.
NO	<p>⚠ Advarsel</p> <ul style="list-style-type: none"> Monter det aldri på høye og vindfulle steder, da markisen kan falle ned og skade folk. 	<ul style="list-style-type: none"> Markisen må trekkes tilbake hvis vindhastigheten når høyere enn 27 km/t.
PT	<p>⚠ Atenção</p> <ul style="list-style-type: none"> Nunca instale em locais altos e ventosos, pois o para-sol pode cair e ferir as pessoas. 	<ul style="list-style-type: none"> O toldo deve ser recolhido se a velocidade do vento for superior a 27 km/h.
RO	<p>⚠ Atenție</p> <ul style="list-style-type: none"> Nu o instalați niciodată în locuri înalte și cu vânt, deoarece copertina ar putea cădea și ar putea răni 	<ul style="list-style-type: none"> oameni. Copertina trebuie retrasă dacă viteza vântului depășește 27 km / h.
SI	<p>⚠ Opozorilo</p> <ul style="list-style-type: none"> Tende nikoli ne namestite na visoka in vetrovna območja, saj lahko senčilo pade in poškoduje ljudi. 	<ul style="list-style-type: none"> Tendo je treba zložiti, če hitrost vetra presega 27 km/h.
HU	<p>⚠ Figyelmeztetés</p> <ul style="list-style-type: none"> Ne szerelje fel magas és szeles helyekre, ugyanis az árnyékoló leeshet és személyi sérülést okozhat. 	<ul style="list-style-type: none"> A napellenzõt be kell húzni, ha a szél sebessége meghaladja a 27 km/h-t.
CZ	<p>⚠ Varování</p> <ul style="list-style-type: none"> Slunečnik nikdy neinstalujte na vysoko postavených a větrných místech, protože se může uvolnit a 	<ul style="list-style-type: none"> způsobit zranění lidem v okolí. Jestliže je rychlost větru vyšší než 27 km/h, markýza musí být stažena.
SK	<p>⚠ Varovanie</p> <ul style="list-style-type: none"> Nikdy zariadenie neinstalujte na vysokých a veterných miestach, pretože môže spadnúť a spôsobiť 	<ul style="list-style-type: none"> zranenia. V prípade, že rýchlosť vetra dosahuje viac než 27 km/h, musíte markízu zatiahnuť.
HR	<p>⚠ Upozorenje</p> <ul style="list-style-type: none"> Nikad je ne postavljajte na visokim i vjetrovitim mjestima jer tenda može pasti i ozlijediti ljude. 	<ul style="list-style-type: none"> Tenda se mora uvući ako je brzina vjetra veća od 27 km/h.
FI	<p>⚠ Varoitus</p> <ul style="list-style-type: none"> Älä koskaan asenna sitä korkeisiin ja tuulisiin paikkoihin, sillä aurinkovarjo saattaa pudota ja vahingoittaa 	<ul style="list-style-type: none"> ihmisiä. Markiisi on vedettävä sisään, jos tuulennopeus ylittää 27 km/h.
LT	<p>⚠ Įspėjimas</p> <ul style="list-style-type: none"> Jos niekuomet nemontuokite aukštese bei vėjutose vietose, nes stoginė nuo saulės gali nuviršti ir 	<ul style="list-style-type: none"> sužaloti žmones. Jei vėjo greitis yra didesnis nei 27 km/h, markizė turi būti įtraukta.
GR	<p>⚠ Προειδοποίηση</p> <ul style="list-style-type: none"> Ποτέ μην εγκαθιστάτε το προϊόν σε σημεία με μεγάλο ύψος και αέρα, καθώς το ακίαστρο ενδέχεται να 	<ul style="list-style-type: none"> πέσει και να προκαλέσει τραυματισμούς. Η τέντα θα πρέπει να μαζεύεται, εάν η ταχύτητα του ανέμου είναι μεγαλύτερη από 27 χιλ./ώρα.
BG	<p>⚠ Предупреждение</p> <ul style="list-style-type: none"> Никога не я инсталирайте на високи и ветровити места, тъй като сенникът може да падне и да 	<ul style="list-style-type: none"> нарани хората. Тентата трябва да бъде прибрана, ако скоростта на вятъра достигне 27 км/ч.
LV	<p>⚠ Brīdinājums</p> <ul style="list-style-type: none"> Nekad neuzstādiēt markīzi augstās un vējainās vietās, jo tā var nokrist un savainot cilvēkus. 	<ul style="list-style-type: none"> Markīze jāievelk, ja vēja ātrums pārsniedz 27 km/h.
EE	<p>⚠ Hoiatus</p> <ul style="list-style-type: none"> Ärge kunagi paigaldage seda kõrgetesse ning tuulistesse kohtadesse, kuna päikesevari võib alla kukkuda 	<ul style="list-style-type: none"> ning inimesi vigastada. Varikatus tuleb kinni panna, kui tuule kiirus ületab 27 km/h.