

## 9030 Basin faucet Installation instructions

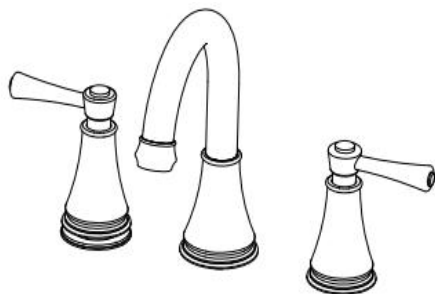

### I 、 Installation Attention

- 1: Ensure that you have gathered all material and tools that are needed for the installation (check with the standard list of accessories ).
- 2: Ensure that your bathtub size match with this faucet.
- 3: Faucet main body has been checked and tested by factory .Please do not dis-assembly it .
- 4: Attention please:Red hose for hot water ,Blue hose for cold water.If the wrong connected, the red and blue logo on the handle will indicate the opposite
- 5: Before install the faucet, please clean the impurities and sludge in the pre-buried pipe, so as to avoid blockage and affect the effluent function.
- 6: Please turn on the faucet after installation, and then check that the connections are tight without leakage.
- 7: Influent water pressure  $\cong 0.1\text{MPa}$  Inlet pressure  $\cong 1.0\text{MPa}$
- 8: The temperature of the medium must not be higher than  $90^{\circ}\text{C}$
- 9: The torque at the mother joint shall not be greater than 10 Nm
- 10: Hose should not be over-bent to ensure that the hose do not deformed after installation.

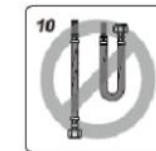
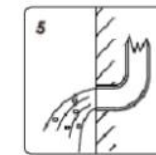

### II 、 standard list of accessories

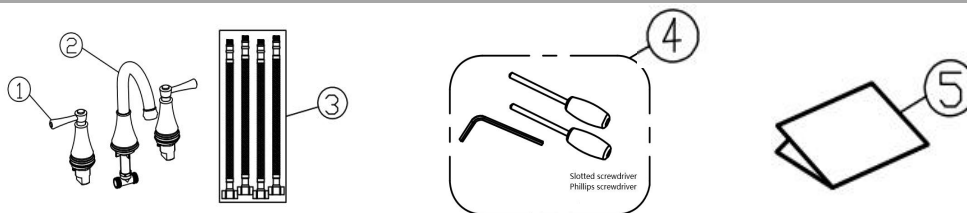

Num	Name	Quantity
1	Handles	2
2	Spout	1
3	Hoses	4
4	Tools bag	1
5	Specification	1

### III 、 Size for products

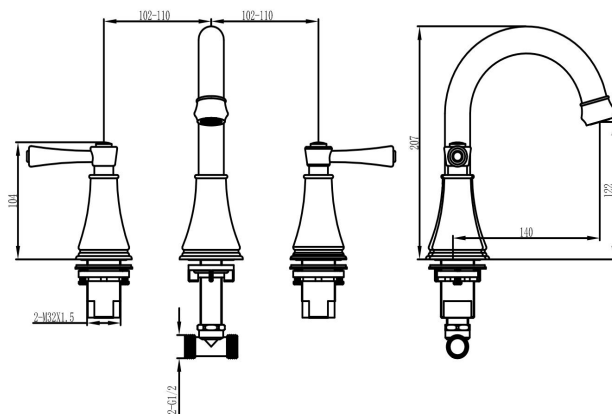

units:mm

Our company has always been continuously improving and improving its product design and performance policy, and reserves the right to change its product specifications without notice.

## IV、 Installation Steps

1

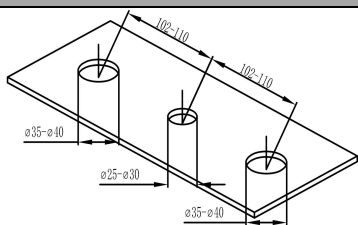

1. As the figure shows, open three holes as the showing size on the table before you install faucet.

2

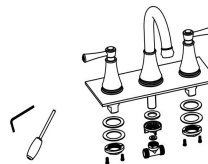

2. As shown in the figure, first remove the three sets of fixed group parts, and then pass each fixed group part under the basin mounting hole according to the removal steps, and then link the main body and the handle respectively.

3

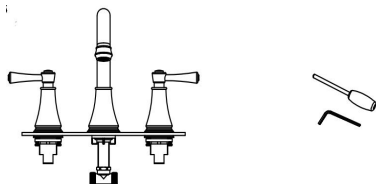

3. As shown in the figure, first install the main body into the main body fixing group parts, adjust the direction of the main body, lock with a lock nut, and then connect the tee. Adjust the handle orientation to connect the base to the fixing assembly and lock it tightly, then use the hex key to lock the handle. The left and right handles are closed.

4

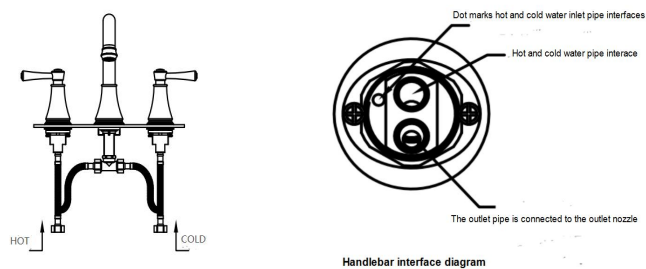

4. As shown in the figure, and then connect the inlet hose accordingly connect (red for hot, blue for cold).

## V、 Using instructions

1. The left hand controls the hot water and the right hand controls the cold water. Turn the left hand wheel counterclockwise to turn on the hot water, turn the right hand wheel clockwise to turn on the cold water

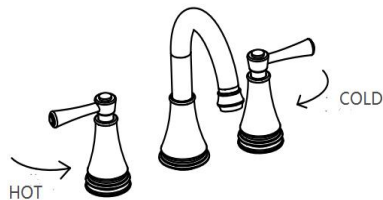

## VI、 Tips

In order to avoid clogging, please regularly disassemble the water outlet to remove debris according to the quality of the water source (as shown in the figure). This can prevent leakage or softening of the outlet nozzle.

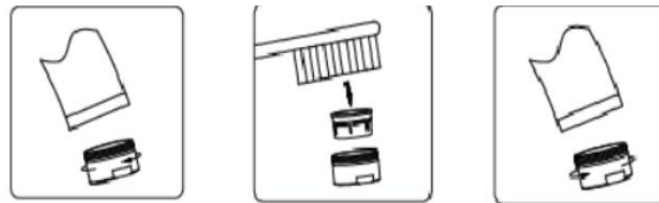

## VII、 Care and maintenance

**In order to protect the faucet surface smooth and bright, please clean the faucet frequently or regularly:**

- Clean with water frequently, and dry the tap with a soft cotton cloth;
- Do not use detergent with coarse particles such as decontamination powder or polishing powder or nylon brush to avoid abrasion of the product.
- Since acid detergent can corrode the coating, it should not be used. If the tiles have been washed with acid detergent, the tiles and utensils should be fully washed immediately to prevent the detergent from flowing to the surface of the faucet and corroding the coating of the faucet.
- Please do not pull the sprinkler tube forcefully to avoid rupture of the tube body.

**If doing a lot of cleaning work, follow the procedure below.**

1. Use clean water and soft cloth to remove dirt and scale film on the surface as much as possible.
2. Use any of the following cleaning agents to remove surface dirt and scale film.

■ Mild liquid cleaner.

■ Colorless glass cleaner, powdered cleaner that is not abrasive and can completely dissolve (and mix as instructed).

■ Polishing fluid without abrasion.

3. After cleaning, please use clean water to remove all the cleaning agent and dry it with a soft cotton cloth.

