

# ASSEMBLY GUIDE

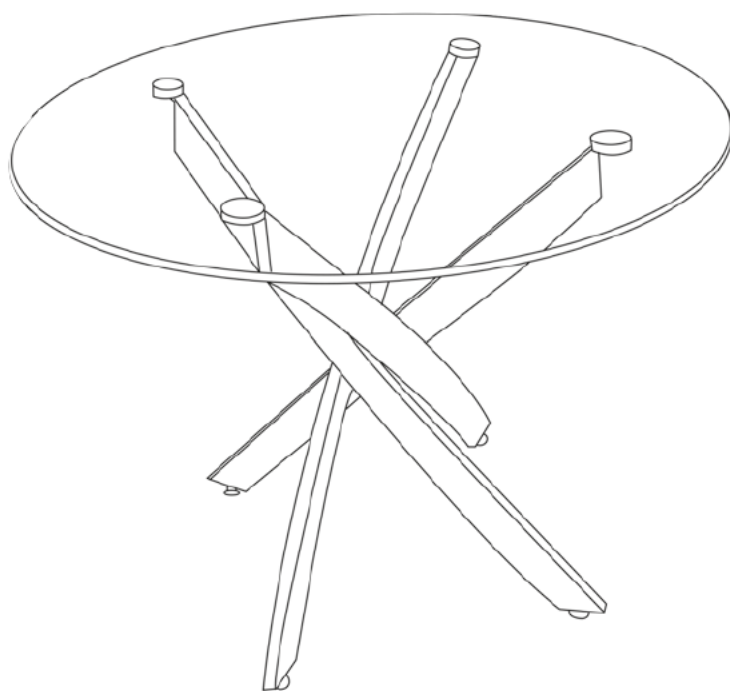

**Important - Please read these instructions fully before starting assembly**



SAFETY AND  
CARE ADVICE



NO POWER TOOLS



### CAUTION

Under no circumstances should hot or cold items be placed directly onto the glass table surface. Table surface mats must be used at all times. Direct exposure to hot or cold items could seriously damage the product and compromise your warranty. For more information please refer to the product care guide booklet.



### SAFETY AND CARE ADVICE

- Check you have all the components and tools listed.
- Remove all fittings from the plastic bags and separate them into their groups.
- We do not recommend the use of power drills/drivers for inserting screws, as this could damage the unit. Only use hand screwdrivers and Allen keys.
- Keep children and animals away from the work area, small parts could cause choking if swallowed.
- Make sure you have enough space to layout the parts before starting.
- Assemble the item as close to its final position (in the same room) as possible.
- Do not overtighten the nuts to avoid causing damage to the threads.
- **Under no circumstances** should liquids be used to clean the underside of the glass table. For full cleaning and care advice, refer to your corresponding product care guide.
- From time to time check that there are no loose screws on this unit
- This product should not be discarded with household waste. Take to your local authority waste disposal centre

## IMPORTANT INFORMATION



45 MINUTE  
BUILD



GLASS



MAXIMUM  
CAPACITY 100Kg



TWO  
PERSON





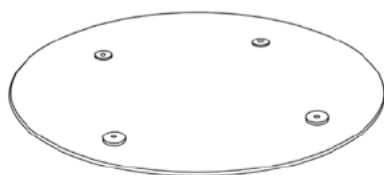



PLEASE CHECK CAREFULLY AND MAKE SURE YOU HAVE ALL FITTINGS AND TOOLS LISTED BELOW BEFORE YOU START.

1 x 1 Table Top



2 x 4 Table Legs



|   |  |  |
|---|--|--|
| <p>A</p>  <p>Rod 8x15mm x4</p>                             | <p>B</p>  <p>Nuts M8 x4</p>         | <p>C</p>  <p>TableFeet x4</p> |
| <p>D</p>  <p>Washers <math>\varnothing</math>8x18mm x8</p> | <p>E</p>  <p>Screws 8x12mm x8</p>   | <p>F</p>  <p>Wrench M8 x1</p> |
| <p>G</p>  <p>Allenkey M5 x1</p>                            | <p>H</p>  <p>ConnectingPiece x1</p> |  |

**NOTE:** The quantities above are the correct amount to complete the assembly. In some cases more fittings may be supplied than are required.

## STEP 1

Use a clear, flat, soft surface to avoid bumps or scratches. Place the table top on the floor with the metal discs facing up. Screw 4 x rods [A] in to the metal discs.

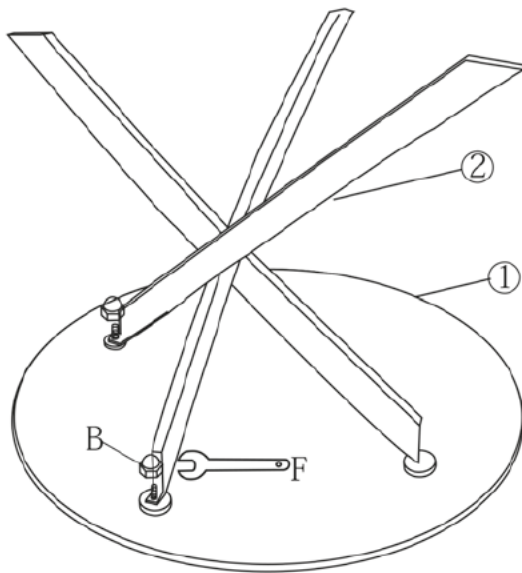
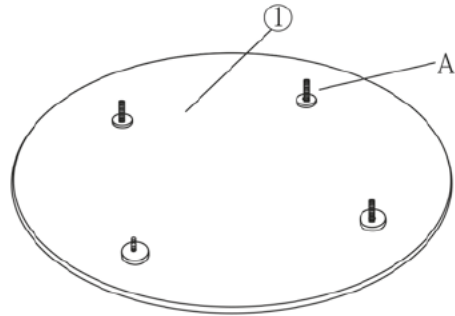

## STEP 2

Place the table legs over the rods on to the metal discs. Use 4 x nuts [B] to secure table legs to table top. Repeat for all 4 table legs. **ATTENTION:** Be careful not to fully tighten fixings yet.

### STEP 3

Add feet [C] to bottoms of table legs.

Connect all four legs together in the middle using the connecting piece [H], washers [D] screws [E]. Tighten with Allen key [G].

Once connecting piece [H] is secured, you can then tighten all the table legs to the table top with wrench [F].

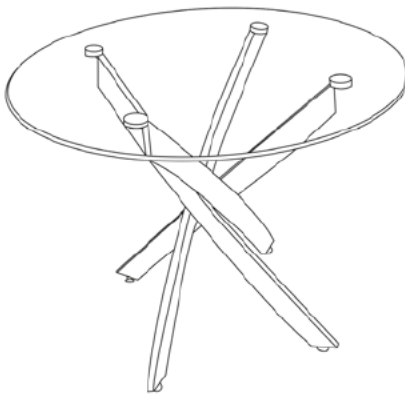
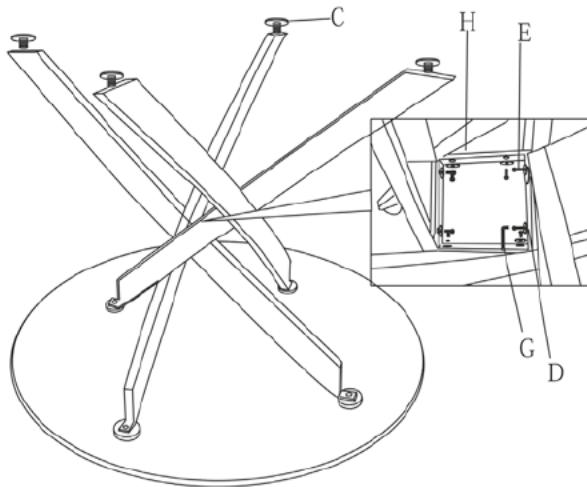

### STEP 4

**ATTENTION:** Carefully, and with help, turn your completed table over so it's now the correct way up. Ensure stability.



## OUR 1 YEAR GUARANTEE

our products come with a 1 year guarantee  
to give you peace of mind shopping at



## WHAT THE GUARANTEE COVERS

---



**PRE-INSERTED FIXINGS**  
e.g. lose metal threads



**FAULTY JOINTS**  
e.g. legs bending



**EXTERNAL FIXING FAULTS**  
e.g. metal discs removing  
from table top



**STRUCTURAL INTEGRITY**  
e.g. the frame of the  
product