

ASSEMBLY INSTRUCTION

**DINING TABLE**

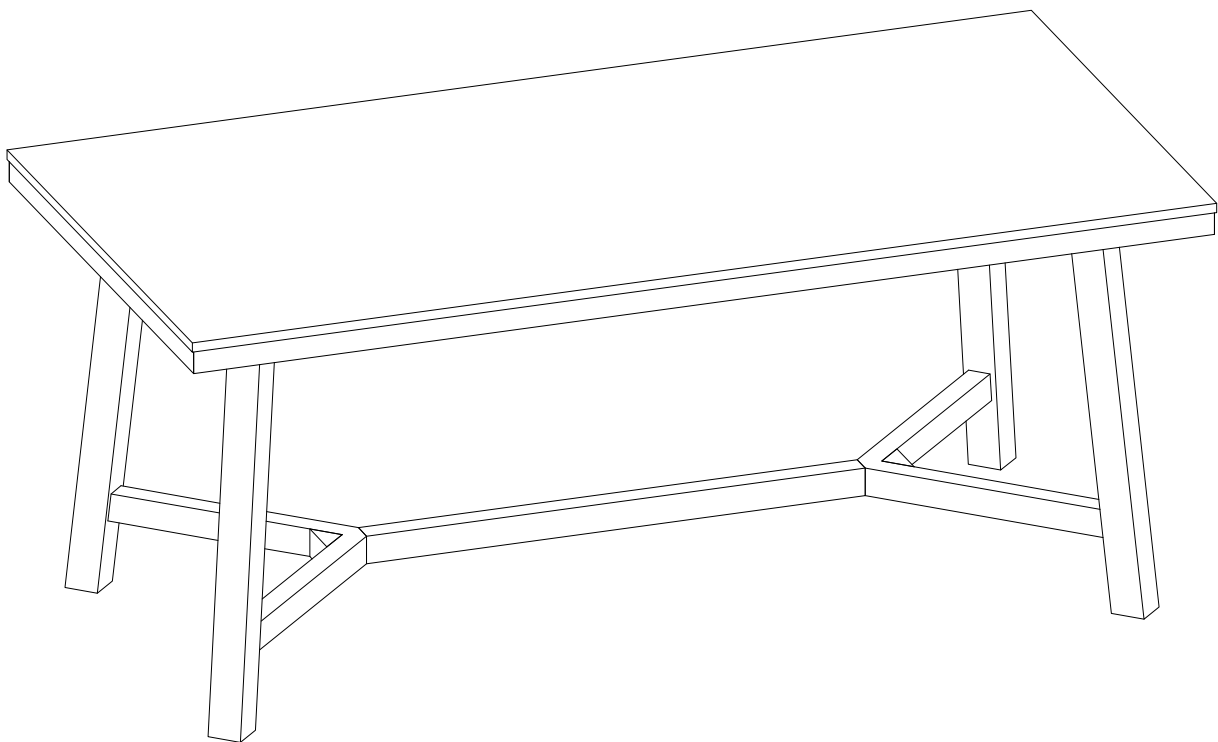

## Please read these instructions fully before starting assembly:

1. Place all wooden parts on a clean and smooth surface such as a rug or carpet to avoid scratching the parts.
2. Kindly follow the assembly instructions step by step.
3. Do not tighten all screws and bolts until the table is fully assembled.
4. Unscrew the protective plastic supports from the metal insert of the legs before assembly.
5. Parts of the assembly will be easier with 2 people.

## Care and maintenance:



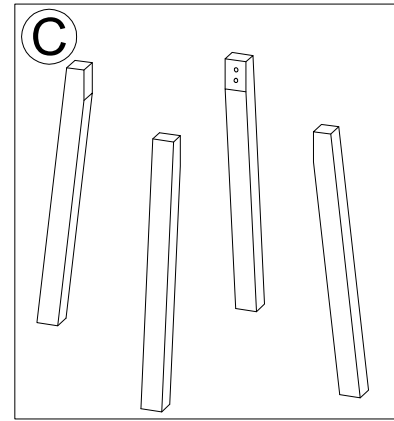
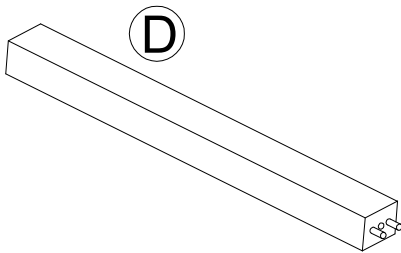
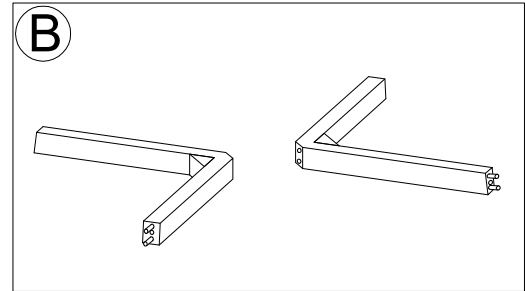
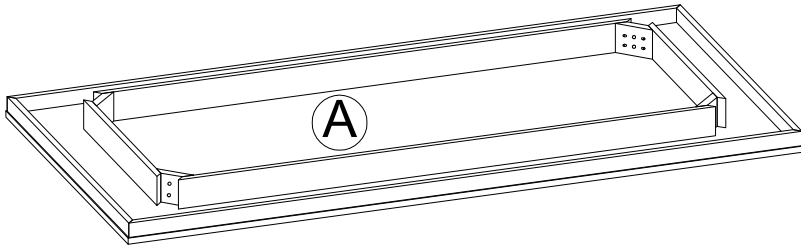

Only clean using a damp cloth and mild detergent, do not use bleach or abrasive cleaners.

# ASSEMBLY INSTRUCTION

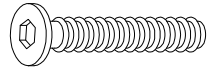
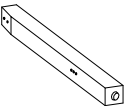
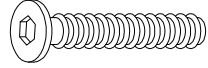
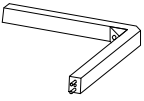

## Part List For One

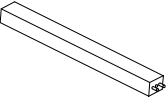

## Hardware List For One

<b>A</b> 	<b>TOP TABLE</b> (1PC)	<b>1</b>  $\text{Ø}5/16" \times 60\text{mm}$	<b>BOLT</b> (12PCS)
<b>B</b> 	<b>TABLE LEG</b> (4PCS)	<b>2</b>  $\text{Ø}5/16" \times 75\text{mm}$	<b>LONG BOLT</b> (2PCS)
<b>C</b> 	<b>STRETCHER</b> (2PCS)	<b>3</b>  $\text{Ø}5/16" \times 13\text{mm}$	<b>SPRING WASHER</b> (14PCS)
<b>D</b> 	<b>LONG STRETCHER</b> (1PC)	<b>4</b>  $\text{Ø}5/16" \times 19\text{mm}$	<b>FLAT WASHER</b> (14PCS)
		<b>5</b>  M4	<b>ALLEN KEY</b> (1PC)

# ASSEMBLY INSTRUCTION

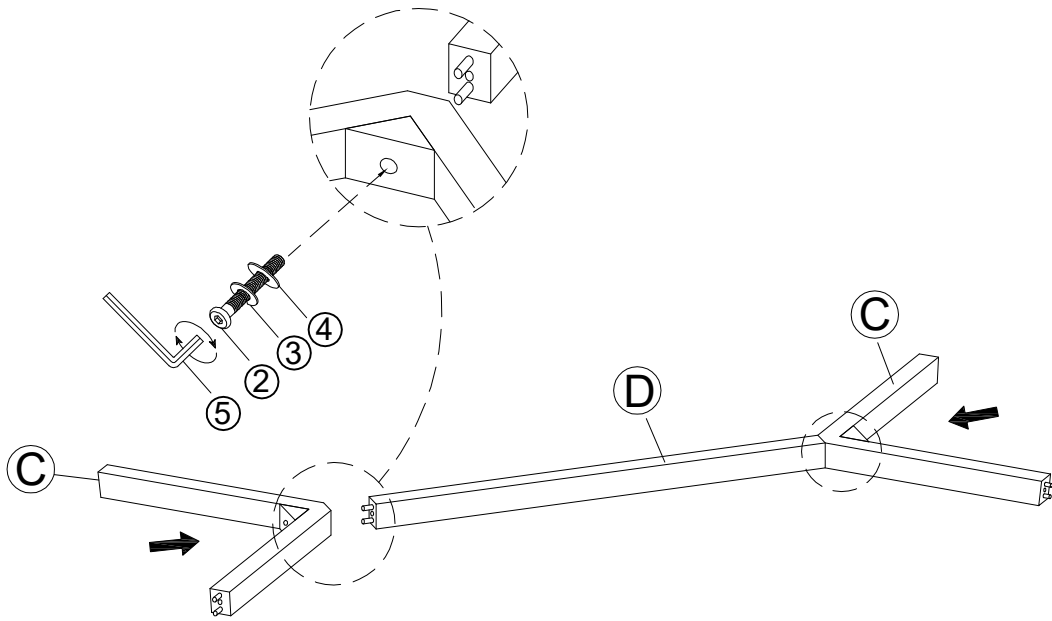



## STEP 1

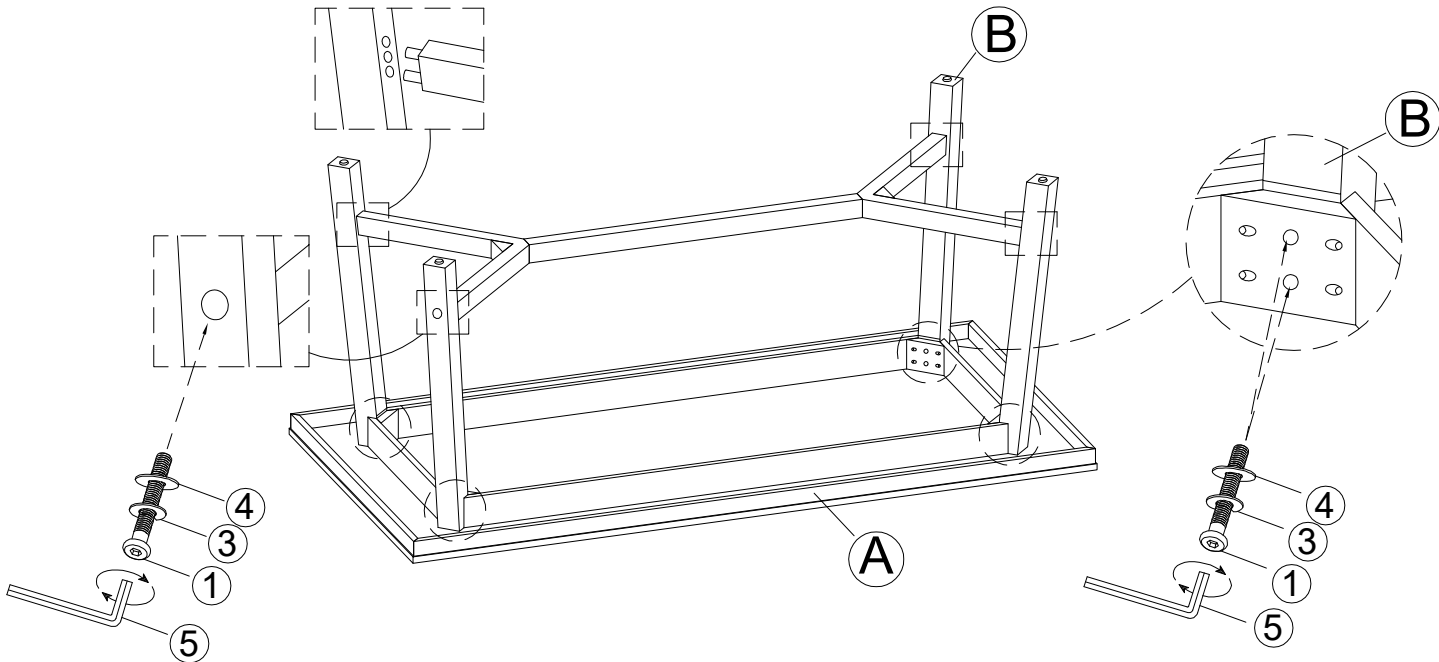

<b>2</b>  LONG BOLT (2PCS) Ø5/16"x75mm	<b>3</b>  SPRING WASHER (2PCS) Ø5/16"x13mm
<b>4</b>  FLAT WASHER (2PCS) Ø5/16"x19mm	<b>5</b>  ALLEN KEY (1PC) M4

## STEP 2



<b>1</b>  LONG BOLT (12PCS) Ø5/16"x60mm	<b>3</b>  SPRING WASHER (12PCS) Ø5/16"x13mm
<b>4</b>  FLAT WASHER (12PCS) Ø5/16"x19mm	<b>5</b>  ALLEN KEY (1PC) M4

# ASSEMBLY INSTRUCTION

COMPLETE

