

USER'S MANUAL

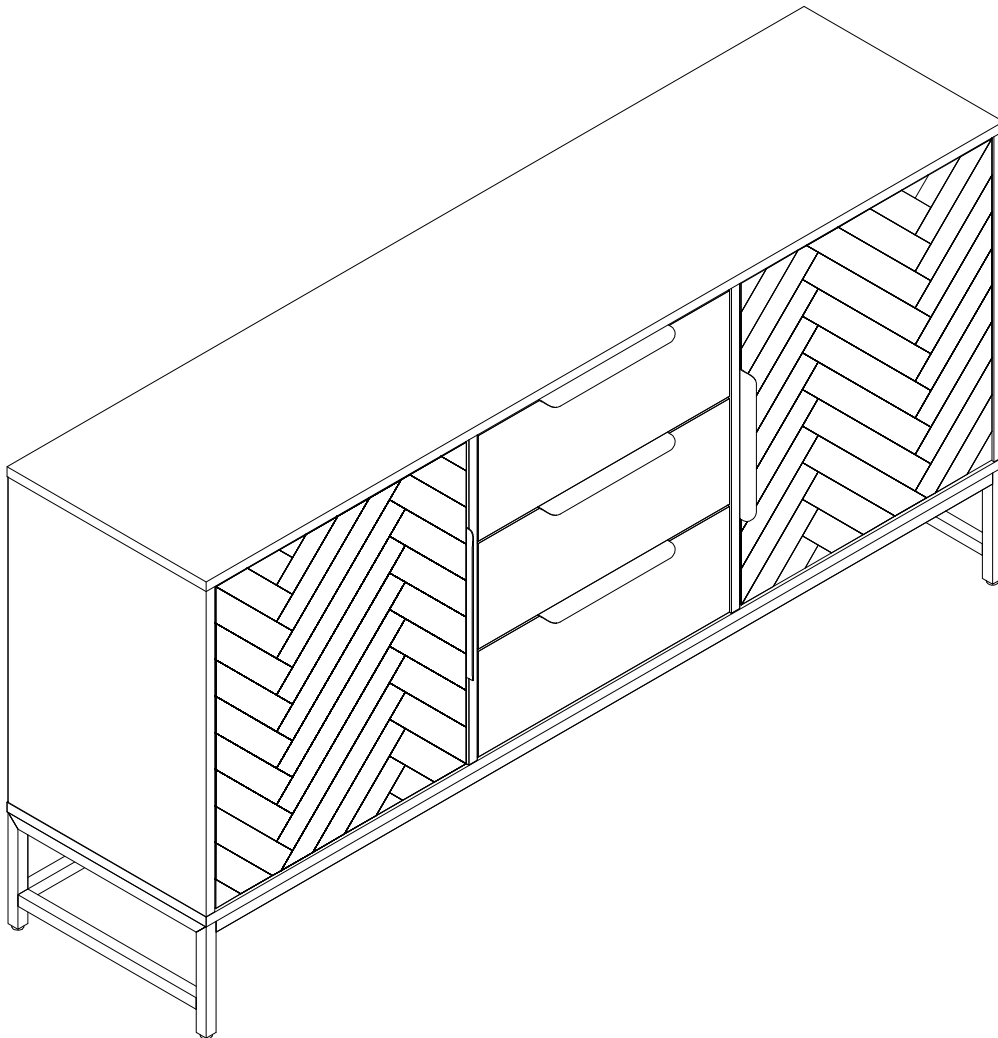

Guide of Manual

- Thanks for your choice. **We will do our best to provide customer service for everyone .**
- Please check to make sure all parts are included as stated when you unpack. If there are parts missing or wrong, please contact us, **we will expeditiously provide reissue accessories, compensation or other services.**
- Instruction should be read carefully. But the manual may not cover every detail of all possible situations and steps. **Please contact us if further information and help are needed. We will respond in a timely manner.**

Warning

- It's kindly advised to assemble this product on a carpeted floor to protect it from being scratched.
- Small parts are included. Please keep the product away from children while as -sembling. Do not let children play or jump on the product. Do not stand on the item or use as a step ladder.
- Please pay attention to the sharp corners during assembly. We recommend the use of gloves to prevent the undesired injury.
- Prior to use, please check to see if there's any loosening screw or part. Make sure that each screw and part is correctly installed and securely fastened.
- It's unnecessary to use electric drill. Please at a low gear if you need.

Care and Maintenance

- Use a soft, clean cloth that will not scratch the surface when dusting.
- There's no need to use furniture polish. If you need, test it first in an inconspicuous area. Using solvents of any kind on your furniture may damage the finish. Never use water to clean your furniture as it may cause damage to the finish.
- Liquid spills should be removed immediately. Gently blot the spill with a soft clean cloth to avoid rubbing.

Further Advice about the Furniture Care

- It is best to keep your furniture in a climate-controlled environment.
- We recommend to keep furniture from sunlight exposure to avoid possible surface damage.
- Following these important and helpful tips will help retain your furniture's performance even when it ages.
- Periodically (every 90 days) make sure the screws are fully tightened.

Max Weight Capacity

- 250LBS [Do not stand on the item]

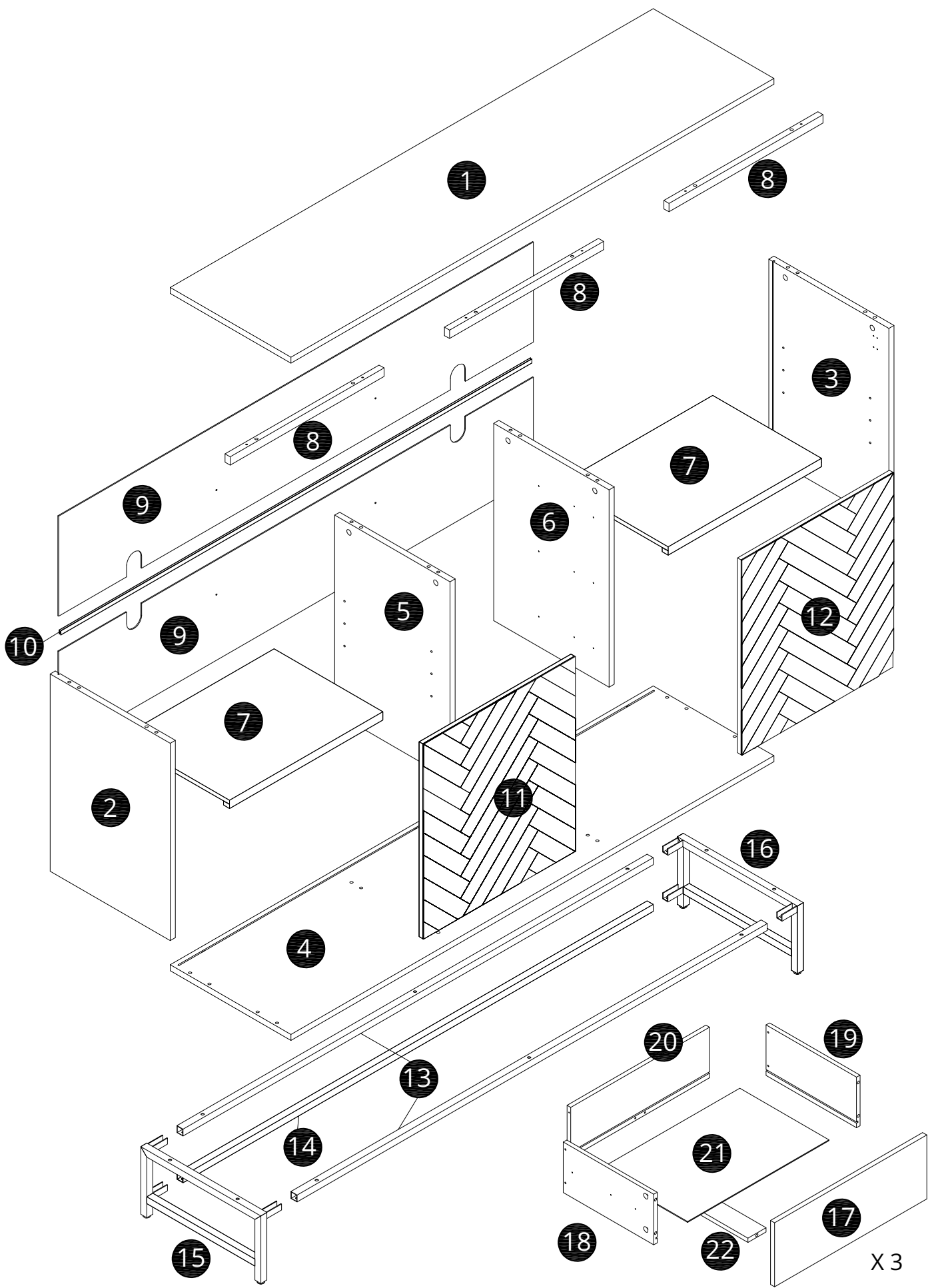

Parts List

Mark sure parts are in the packge

① x 1pc
Top panel

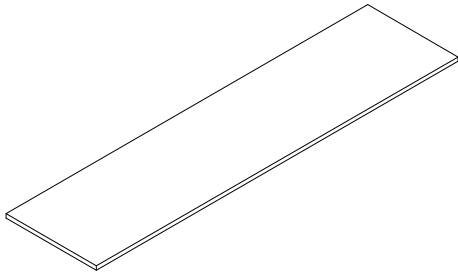

② x 1pc
Left side panel

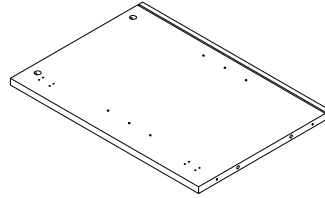

③ x 1pc
Right side panel

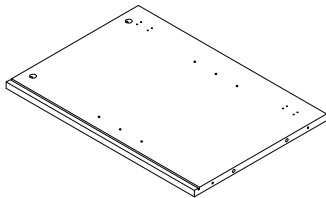

④ x 1pcs
Bottom panel

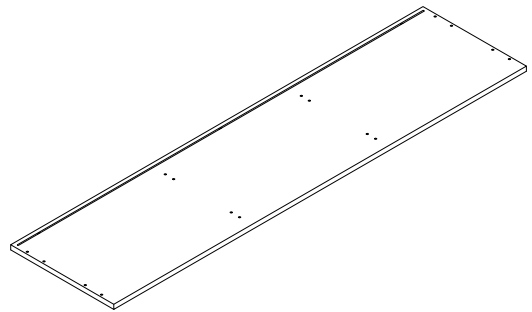

⑤ x 1pc
Left Partition panle

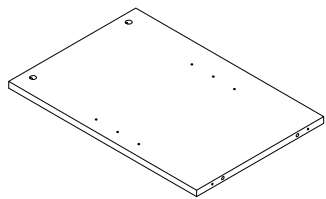

⑥ x 1pc
Right Partition panle

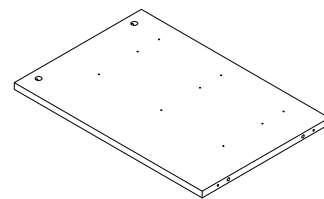

⑦ x 2pcs
Adjustable Shelf

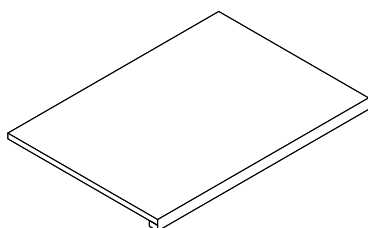

⑧ x 3pcs
Door stoper

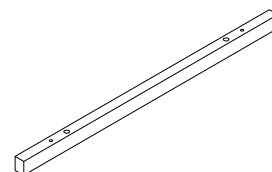

Parts List

Mark sure parts are in the packge

⑨ x 2pcs
Back Panel

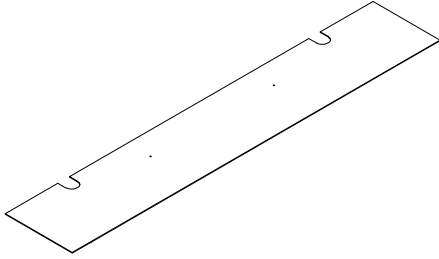

⑩ x 1pc
H-shaped plastic strip

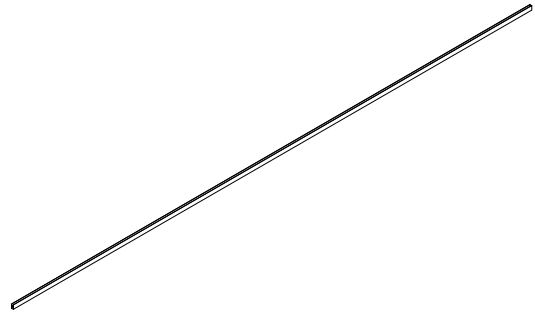

⑪ x 1pc
Left Door

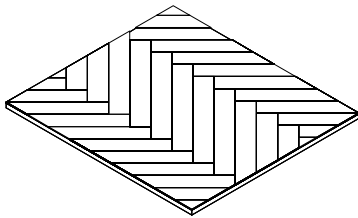

⑫ x 1pcs
Right Door

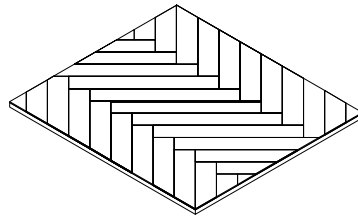

⑬ x 2pcs
Front back foot frame
connecting rod

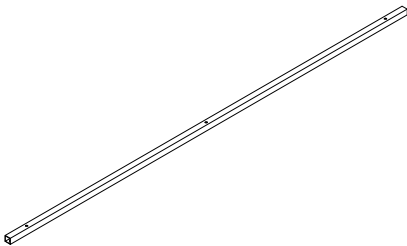

⑭ x 1pc
back foot frame
connecting rod

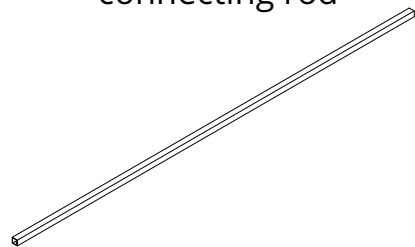

⑮ x 1pc
Side foot frame

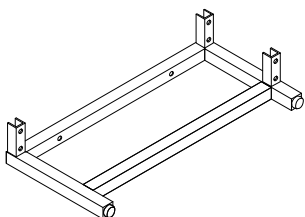

⑯ x 1pc
Right foot frame

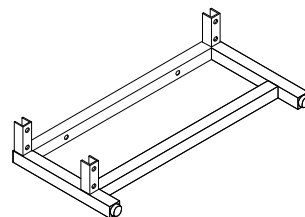

Parts List

Mark sure parts are in the packge

①⑦ x 1pc
drawer front panel

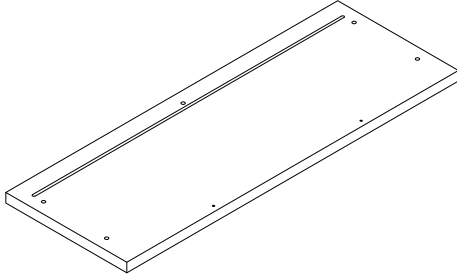

①⑧ x 1pc
left side drawer

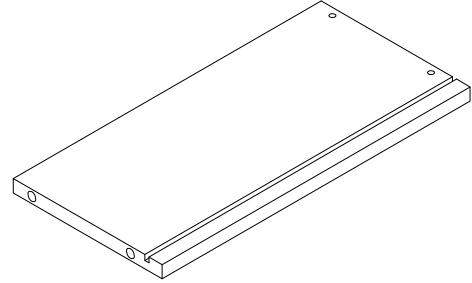

①⑨ x 1pc
Right side drawer

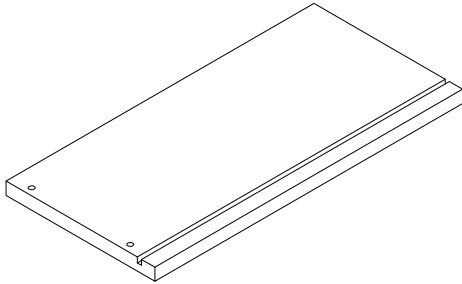

②⑦ x 1pc
Back drawer

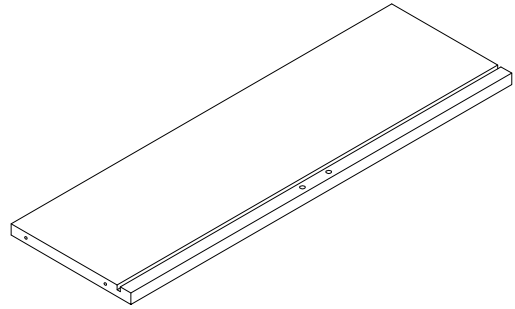

②① x 1pc
Bottom drawer

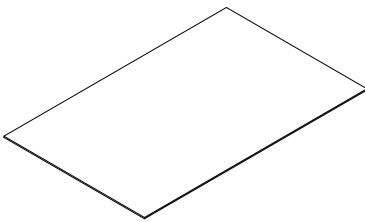



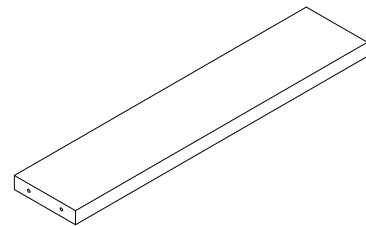



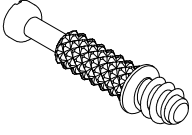

②② x 1pc
Bottom support strip

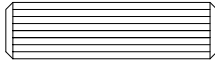



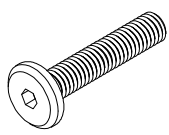
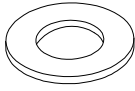

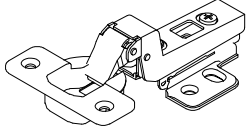
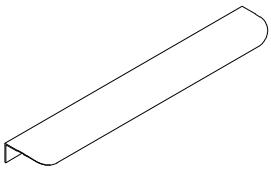
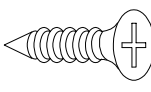



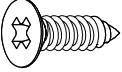

Parts List

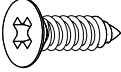
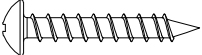
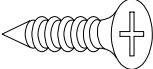
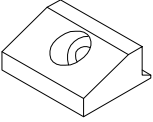
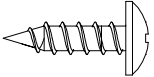
"+ in below list indicates that additional pieces are replacement parts"

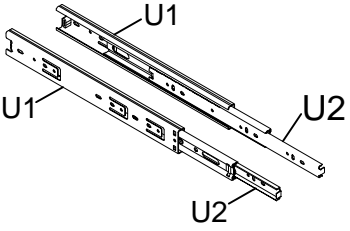
<p>A x 23+2 pcs</p>  <p>cam bolt M6*35mm</p>	<p>B x 23+2 pcs</p>  <p>Cam lock Ø15*9.5mm</p>	<p>C x 22+2 pcs</p>  <p>Wood dowel Ø8*30mm</p>
<p>D x 8+2 pcs</p>  <p>Screw Ø6*50mm</p>	<p>E x 8+2 pcs</p>  <p>Shelf Support Pin</p>	<p>F x 12 pcs</p>  <p>Bolt 1/4"*12mm</p>
<p>G x 10+2 pcs</p>  <p>Bolt 1/4"*32mm</p>	<p>H x 10+2 pcs</p>  <p>washer 1/4"*19mm</p>	<p>I x 10+2 pcs</p>  <p>washer 1/4"*11mm</p>
<p>J x 4 pcs</p>  <p>Large radian curved door hinge(Inbuilt) Ø35mm</p>	<p>K x 5 pcs</p>  <p>Handel 260*37*18mm</p>	<p>L x 10+2 pcs</p>  <p>flat head screw Ø3.5*12mm</p>

Parts List

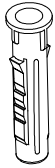
"+ in below list indicates that additional pieces are replacement parts"

<p>M x 24+2 pcs</p>  <p>flat head screw Ø3.5*15mm</p>	<p>N x 18+2 pcs</p>  <p>flat head screw Ø4*35mm</p>	<p>O x 36+2 pcs</p>  <p>flat head screw Ø3.5*12mm</p>
<p>P x 6+1 pcs</p>  <p>Round headscrew Ø4*25mm</p>	<p>Q x 12+2 pcs</p>  <p>flat head screw Ø3*17mm</p>	<p>R x 12+2 pcs</p>  <p>plastic wedge</p>
<p>S x 4+1 pcs</p>  <p>Round headscrew Ø3*15mm</p>	<p>T x 1 pc</p>  <p>Allen Wrench M4</p>	<p>U x 3 set</p>  <p>Ball bearing slide rail 12"*35mm</p>
<p>V 2 set-Anti-tipping-kit</p>  <p>wall strap 2pcs</p>  <p>screw Ø4*35mm 2pcs</p>  <p>screw Ø3.5*15mm 2pcs</p>  <p>wall anchor Ø8*30mm 2pcs</p>  <p>washer Ø14mm 4pcs</p>		

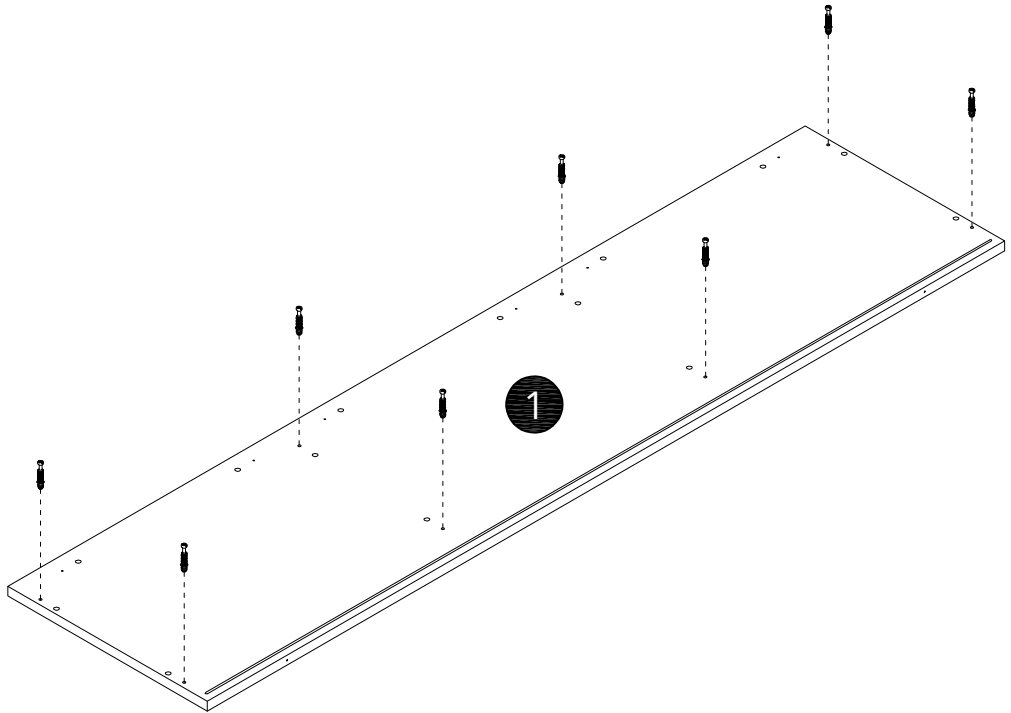
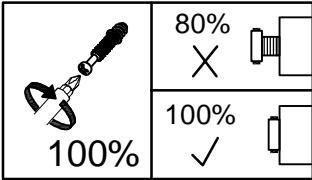
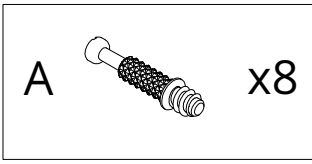

1



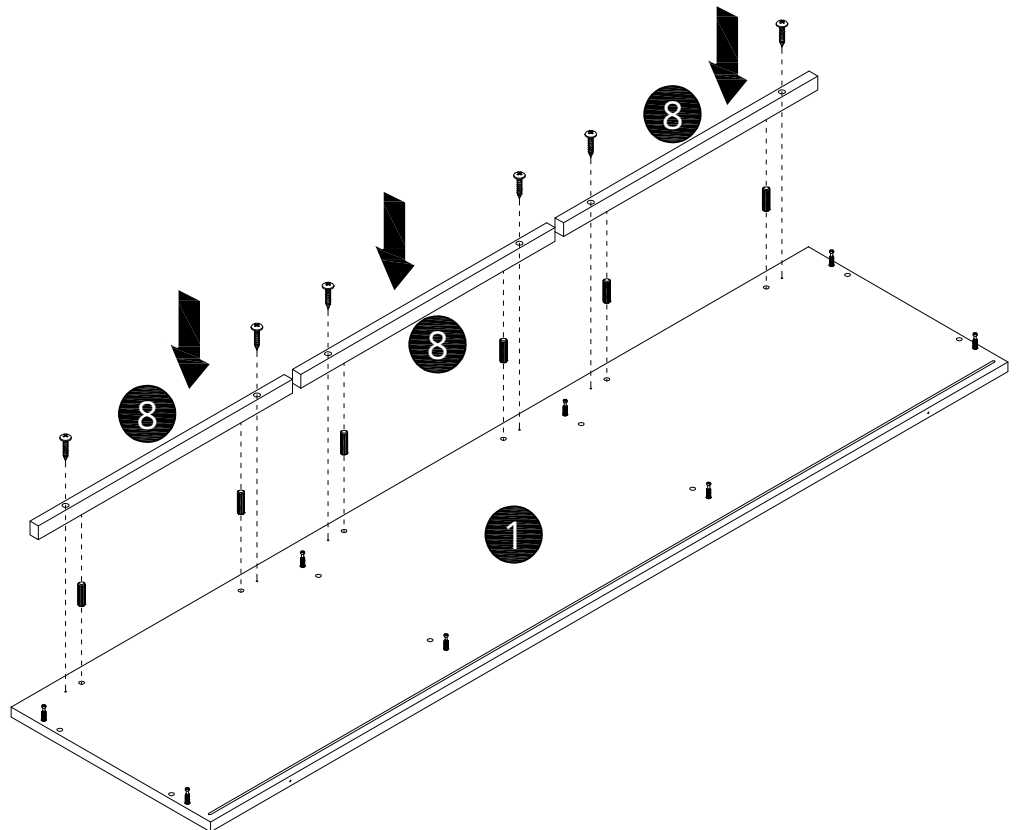
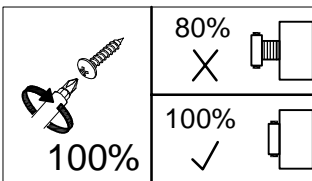
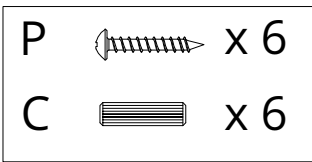

2

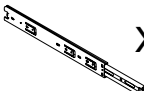



3

- U1  x 6
- O  x 18

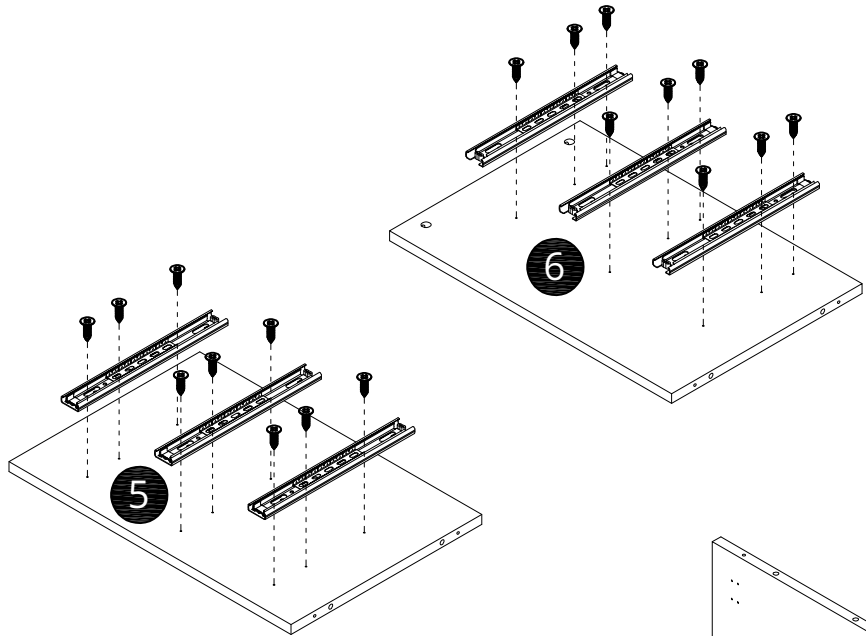
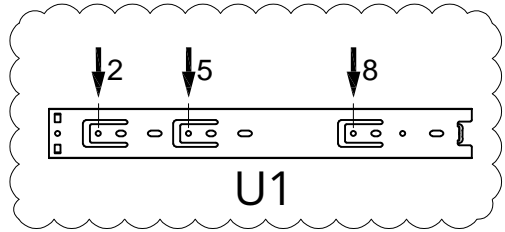
	80% 
	100% 



4

- B  x 8
- C  x 8

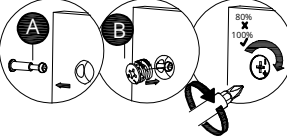

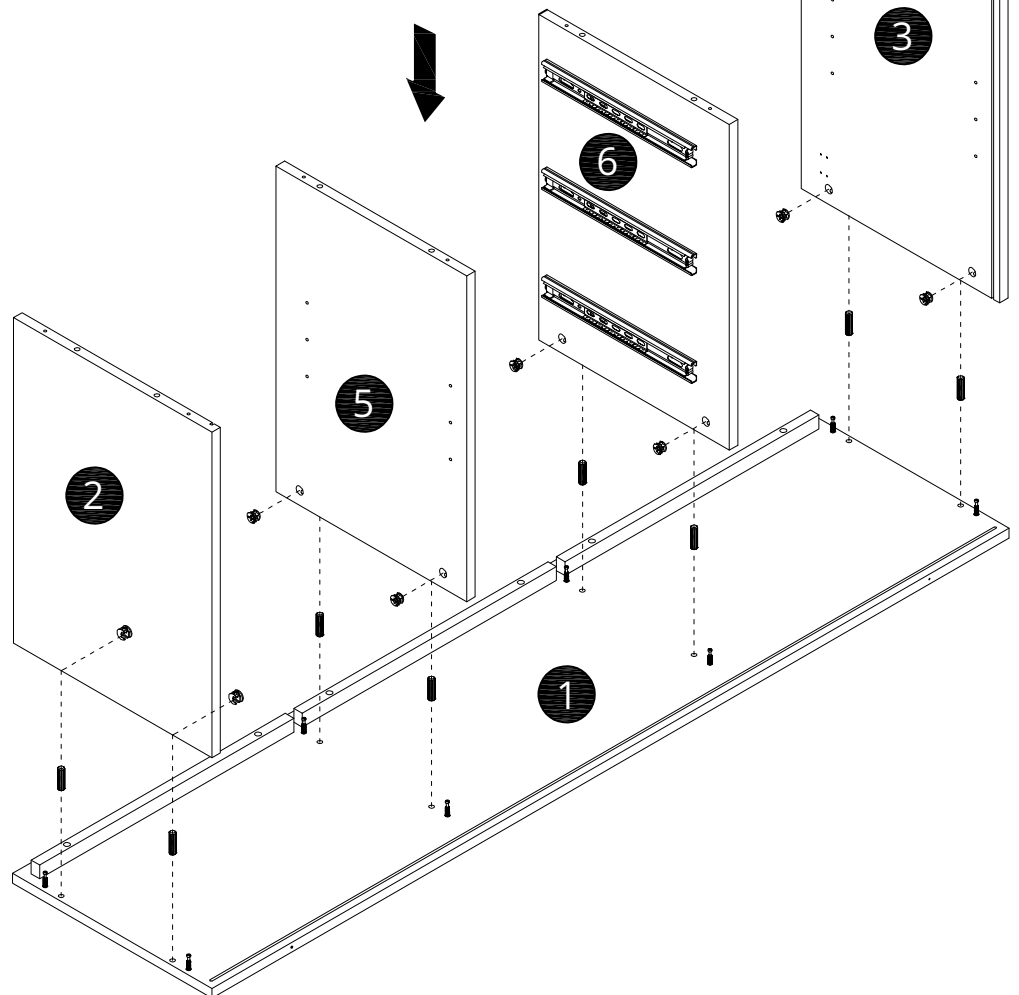

Align "A" with the hole on the connecting board and insert press "B" into hole tighten it clockwise

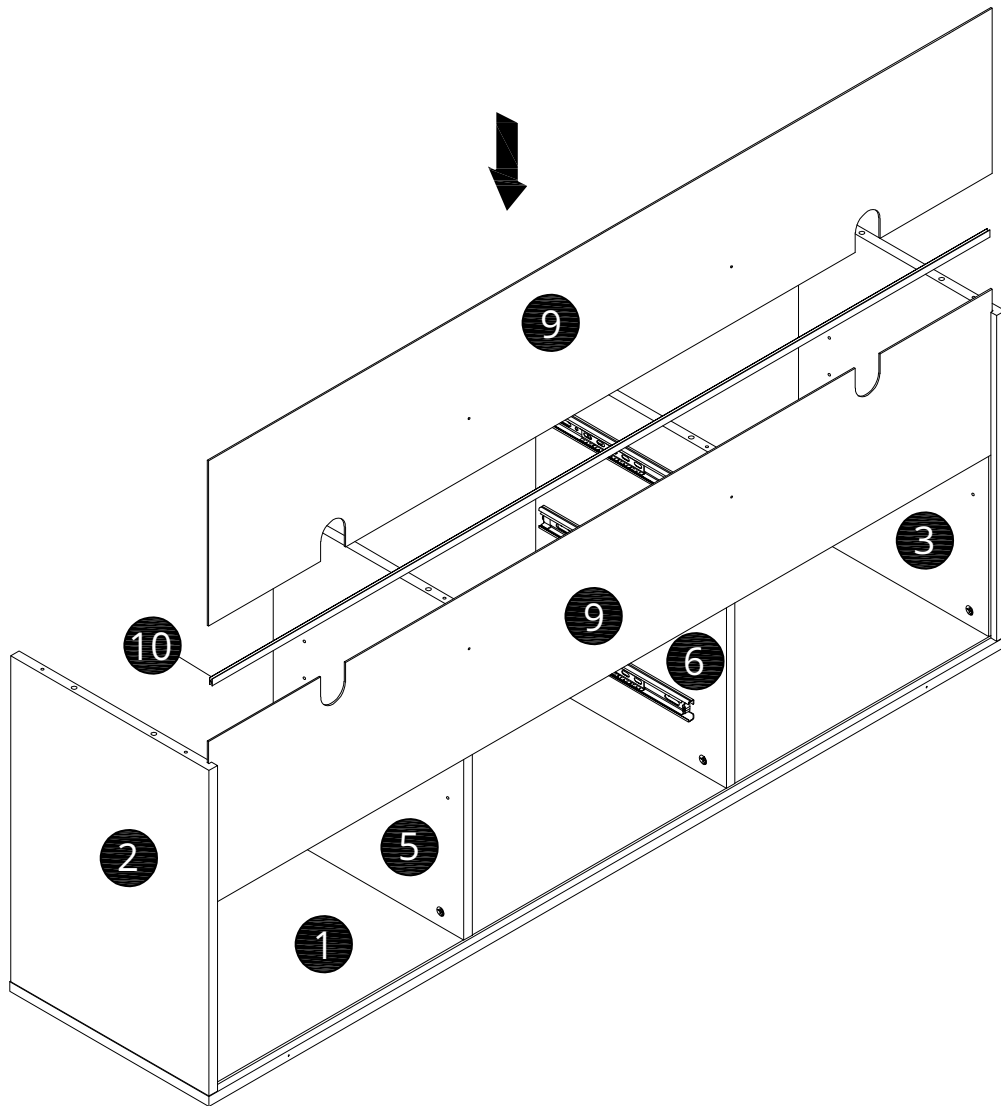

5





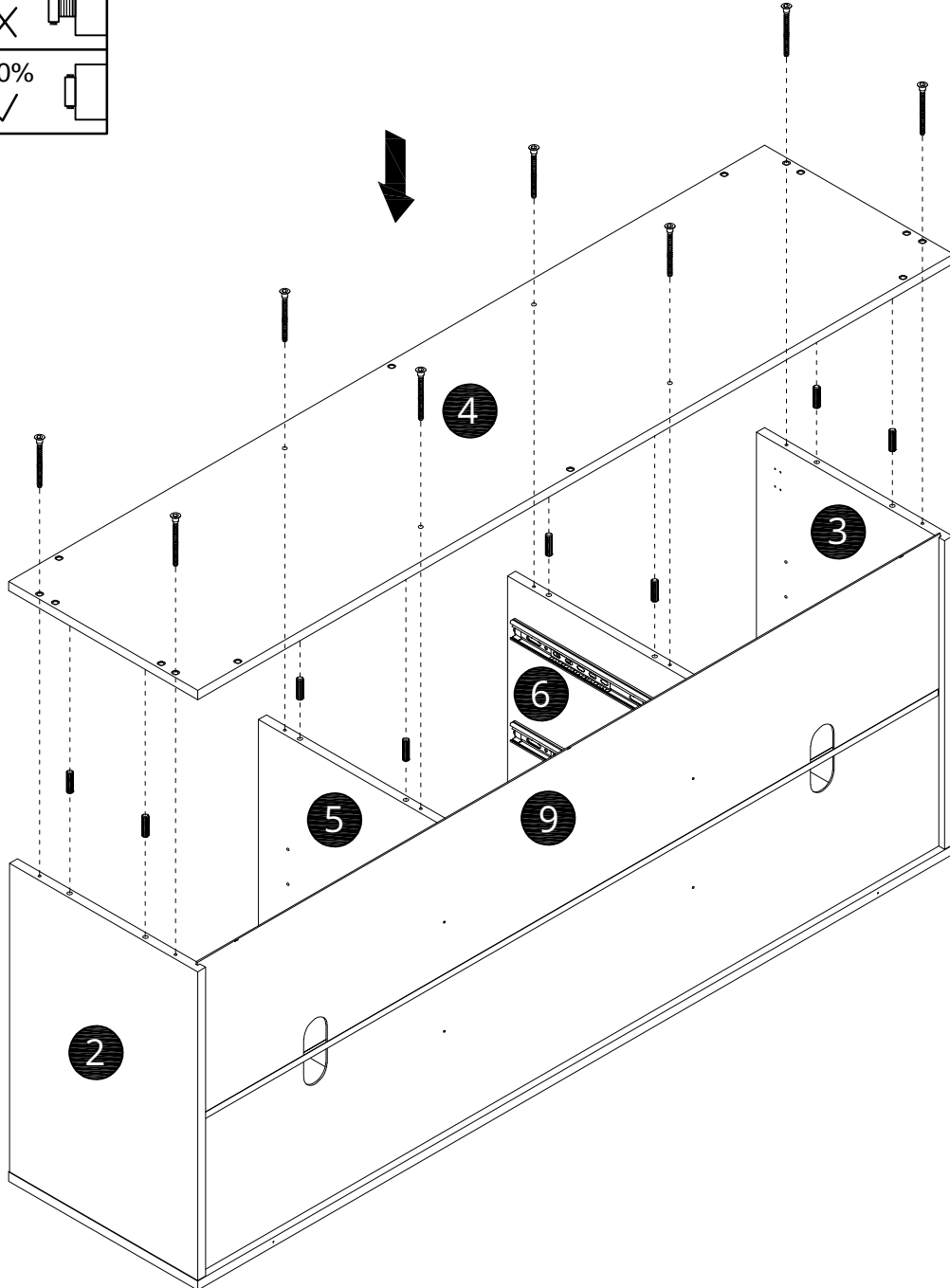
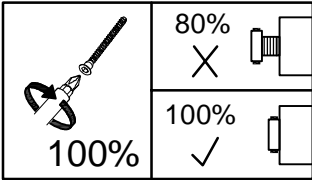

6

- D  x 8
- C  x 8





7

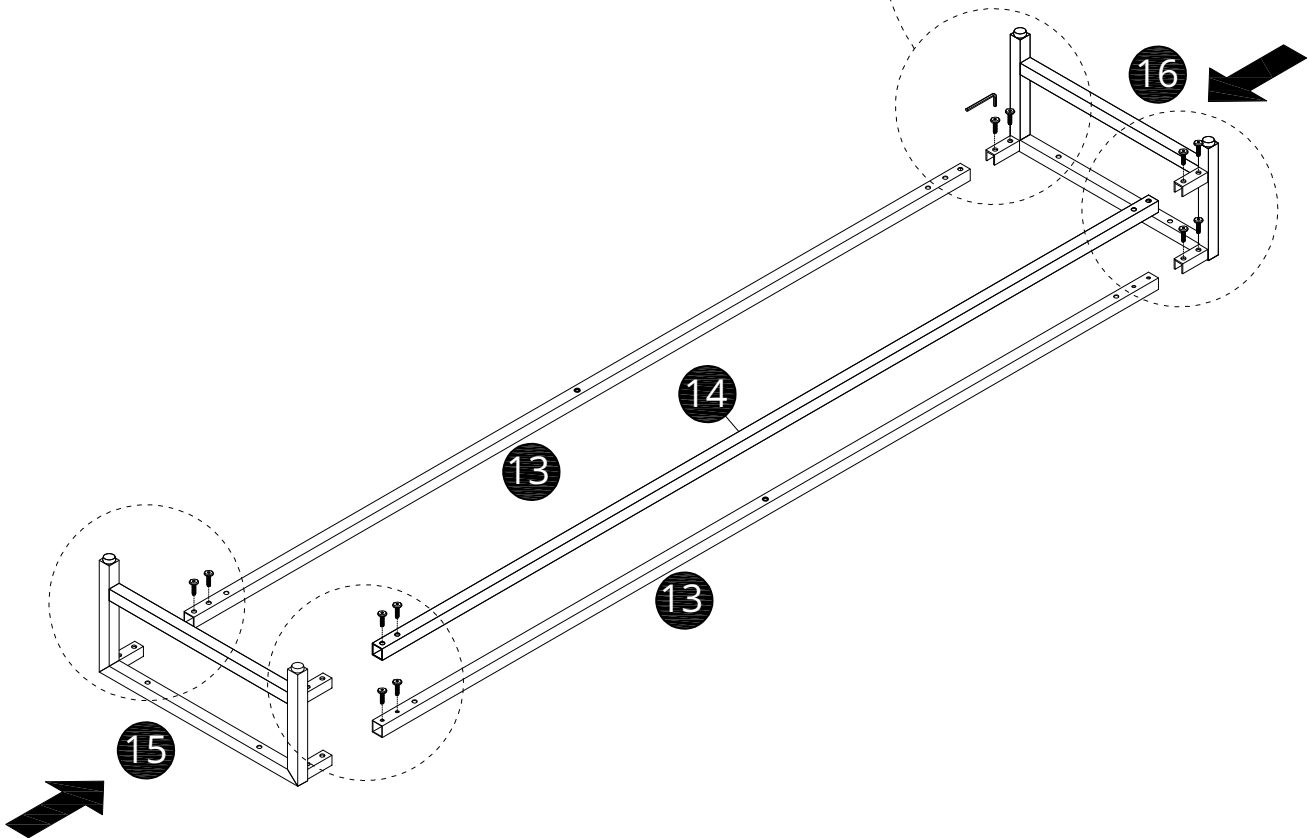
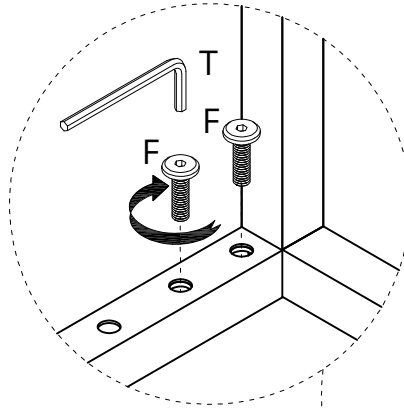

F  x 12

	80% X	
	100% ✓	



8



G		x 10
H		x 10
I		x 10

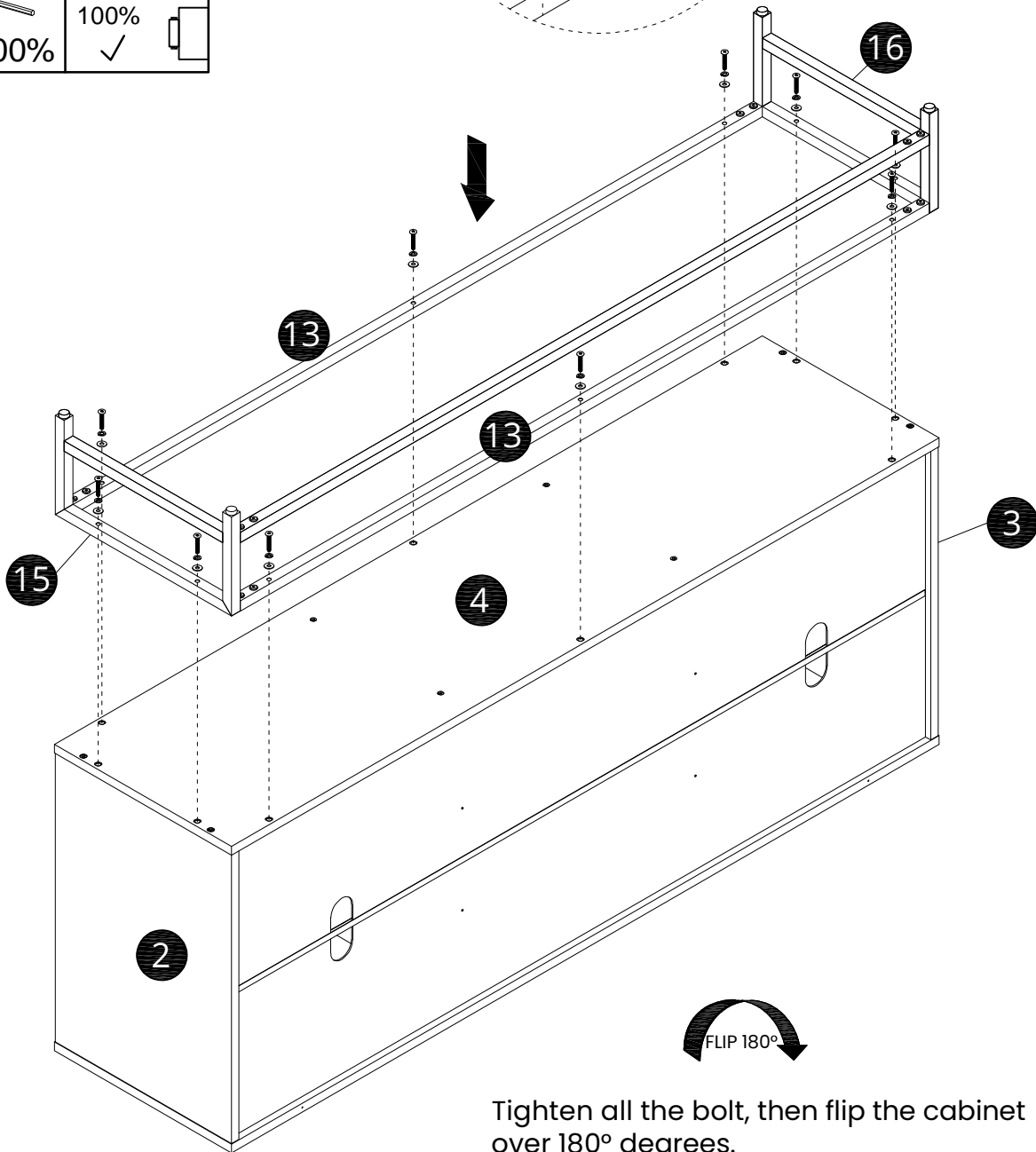
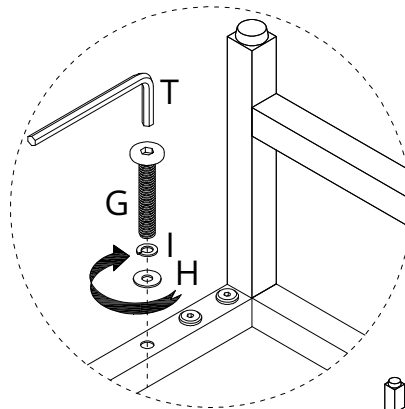

	80% X	
	100% ✓	



Tighten all the bolt, then flip the cabinet over 180° degrees.



9

- J  x 4
- M  x 8

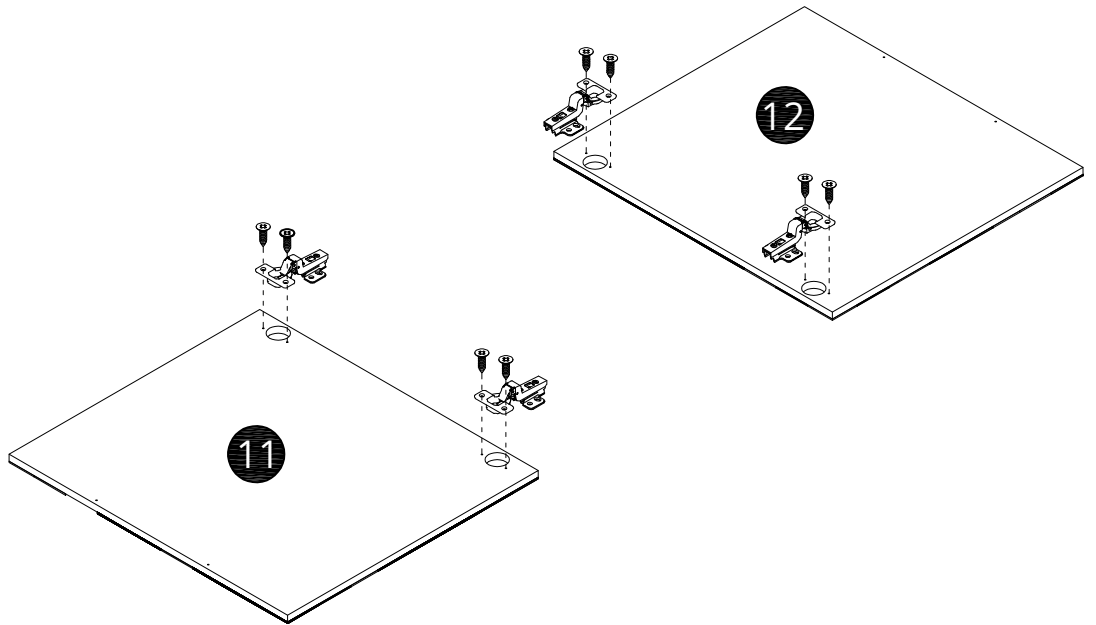

	80% 
	100% 



10

- M  x 16
- L  x 4

- K  x 2

	80% 
	100% 

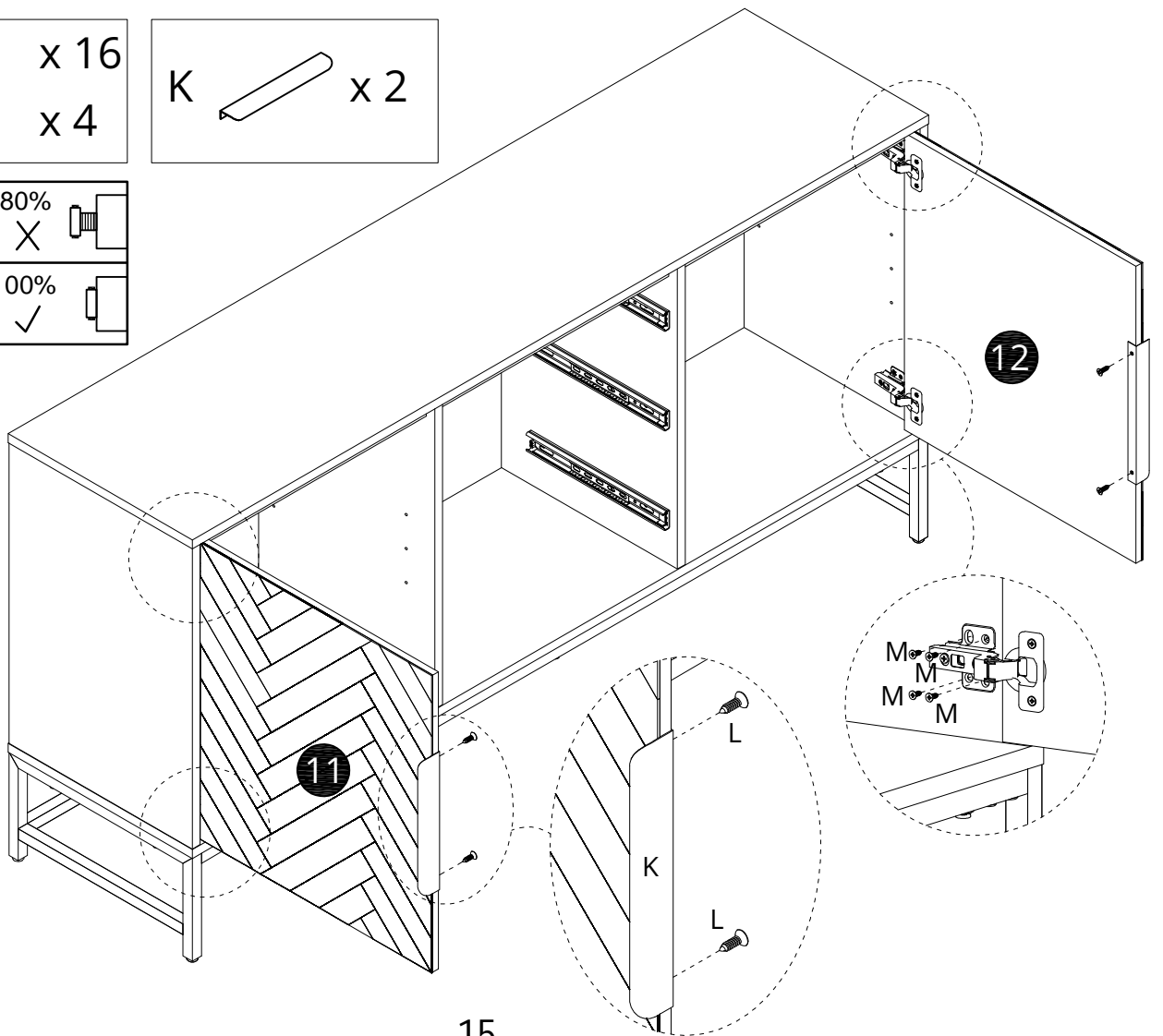

11

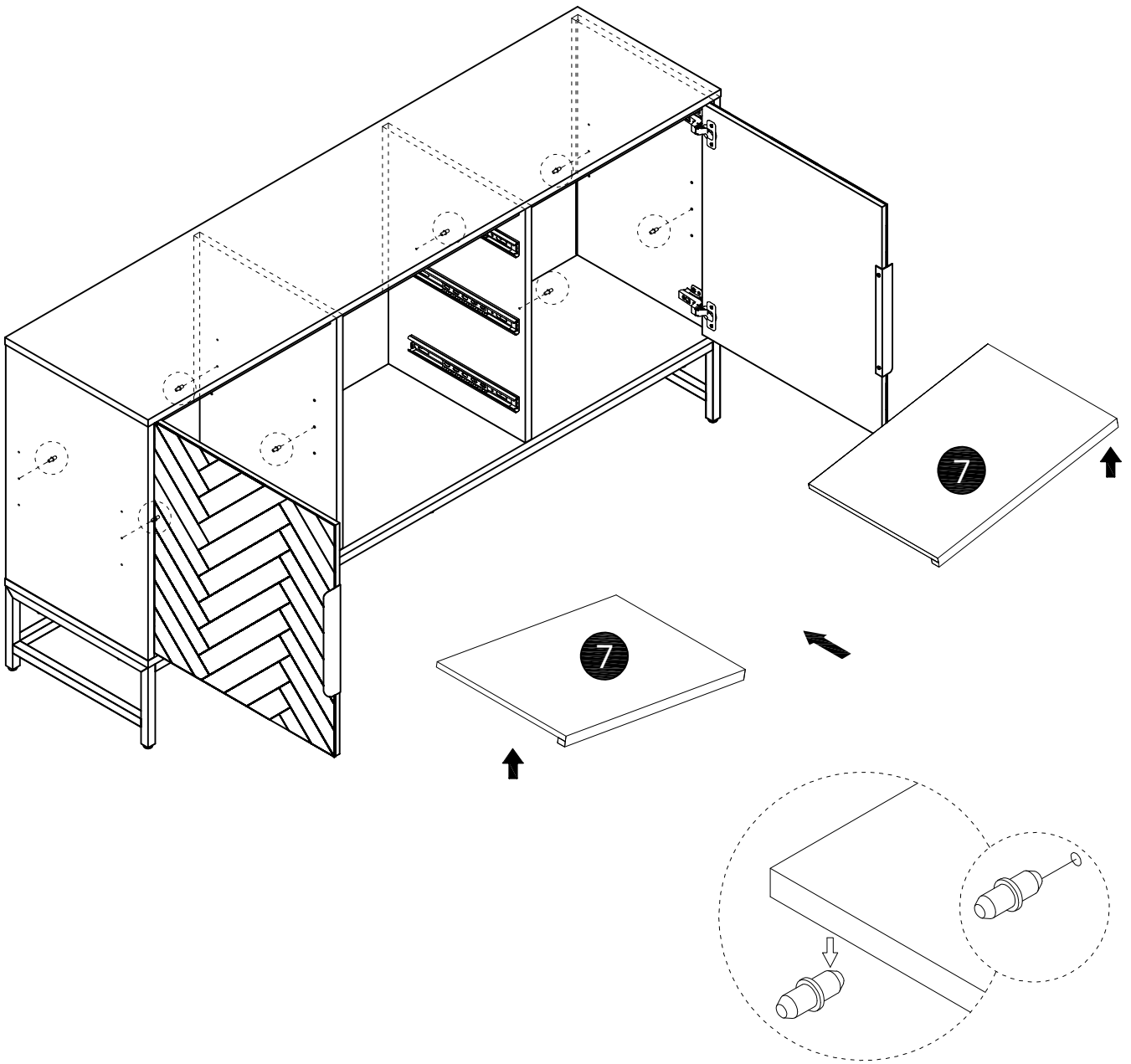
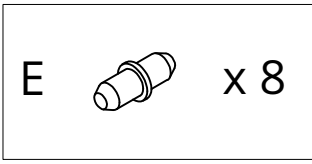

12

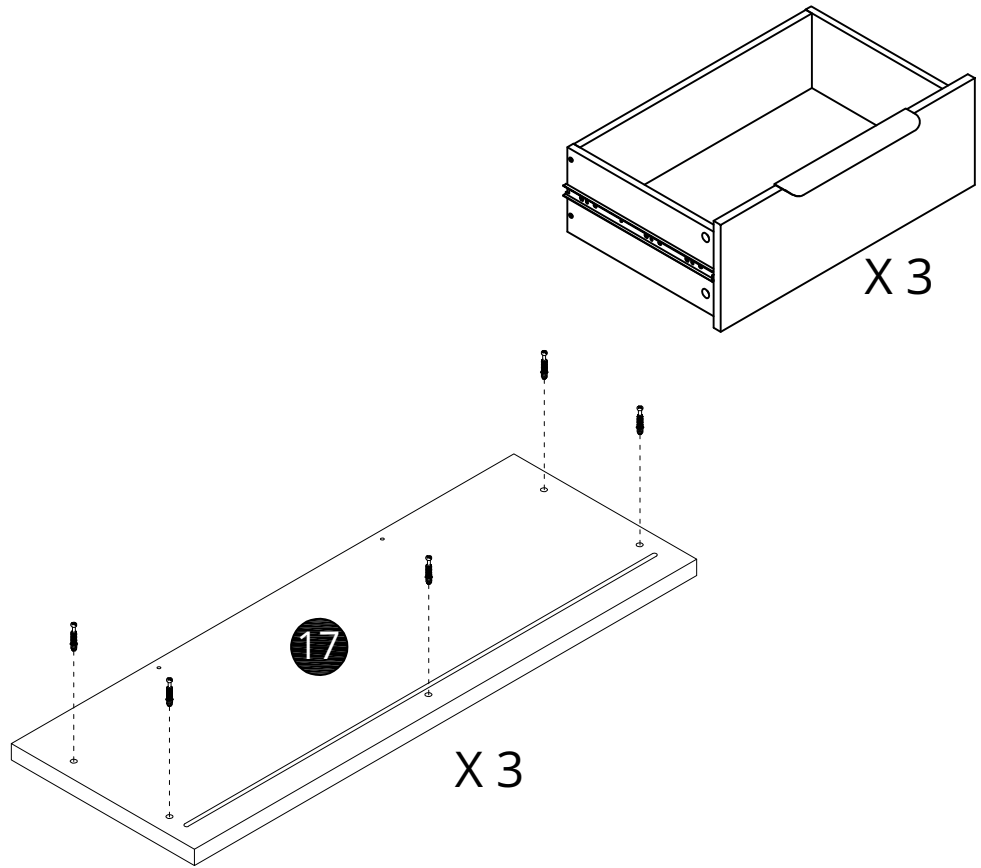
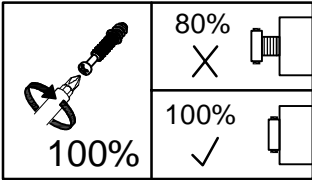
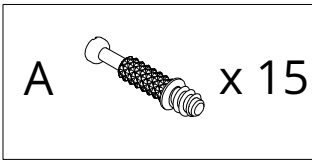

13

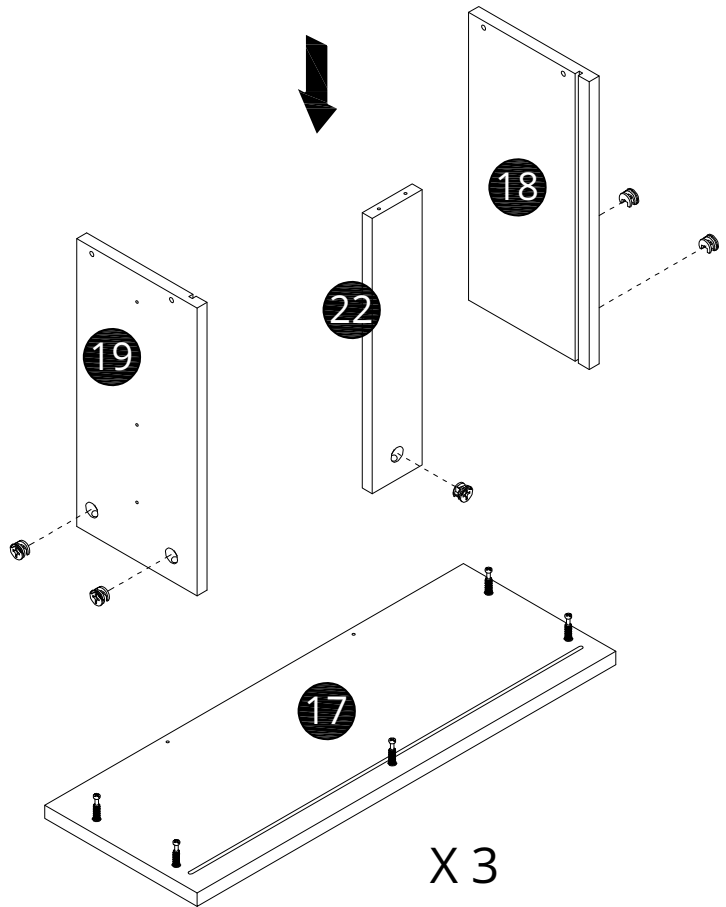
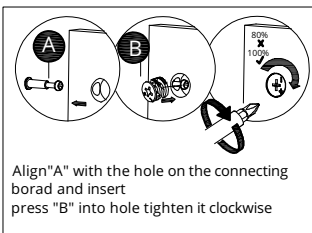
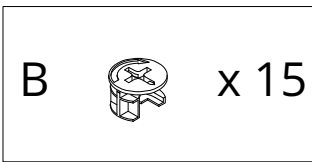

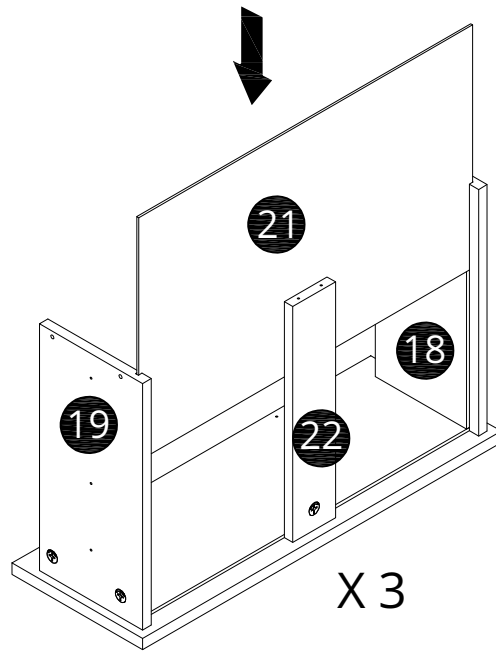

14



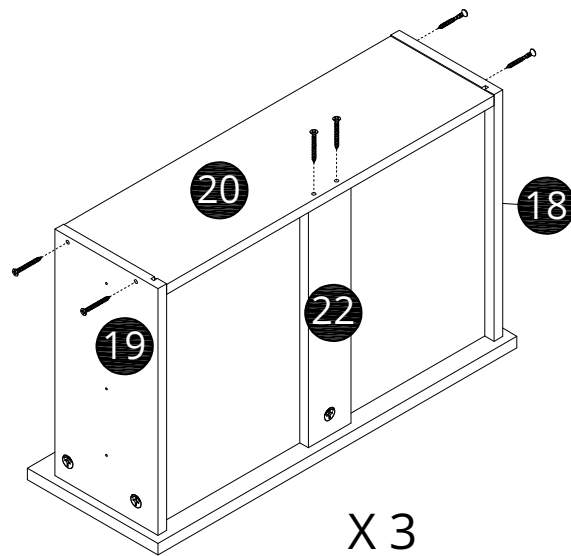
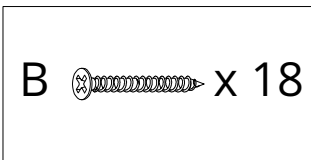

15





16

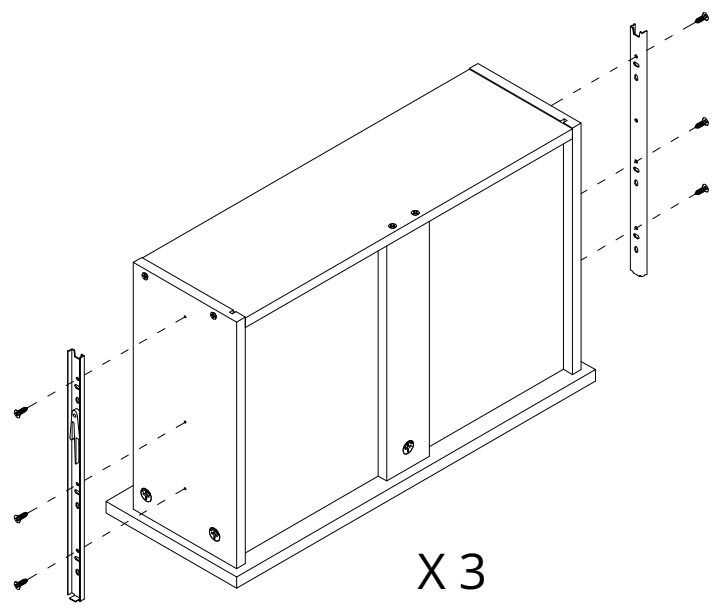
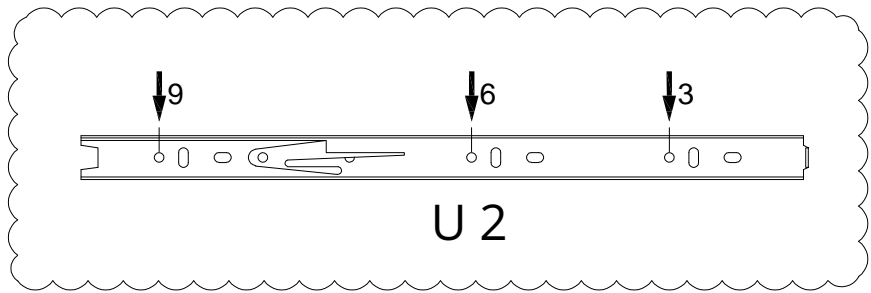

U2		x 6
O		x 18

	80% X	
	100% ✓	

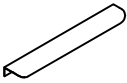

17



K		x 3
L		x 6

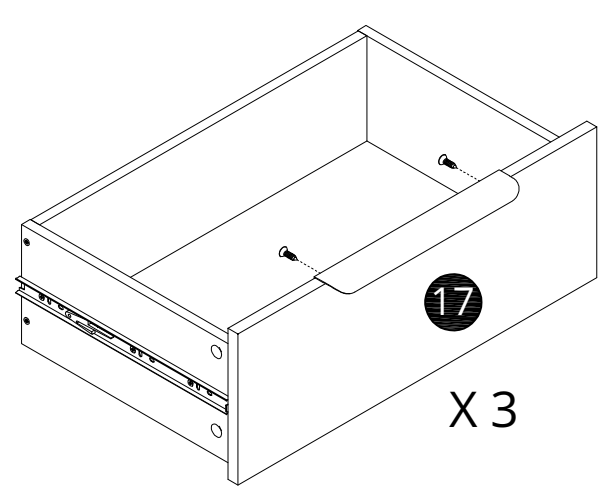

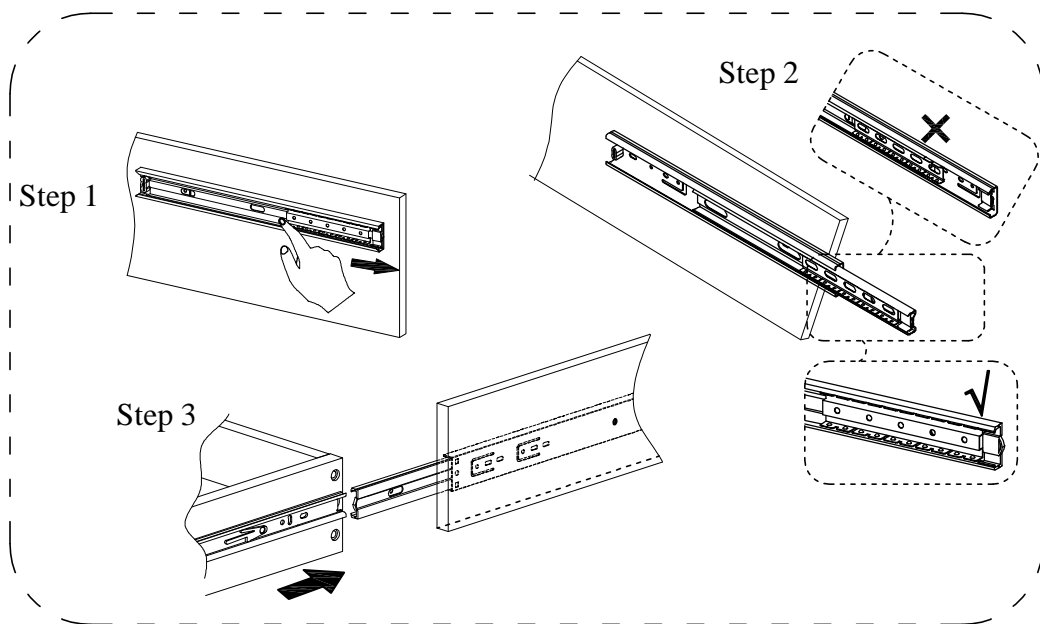
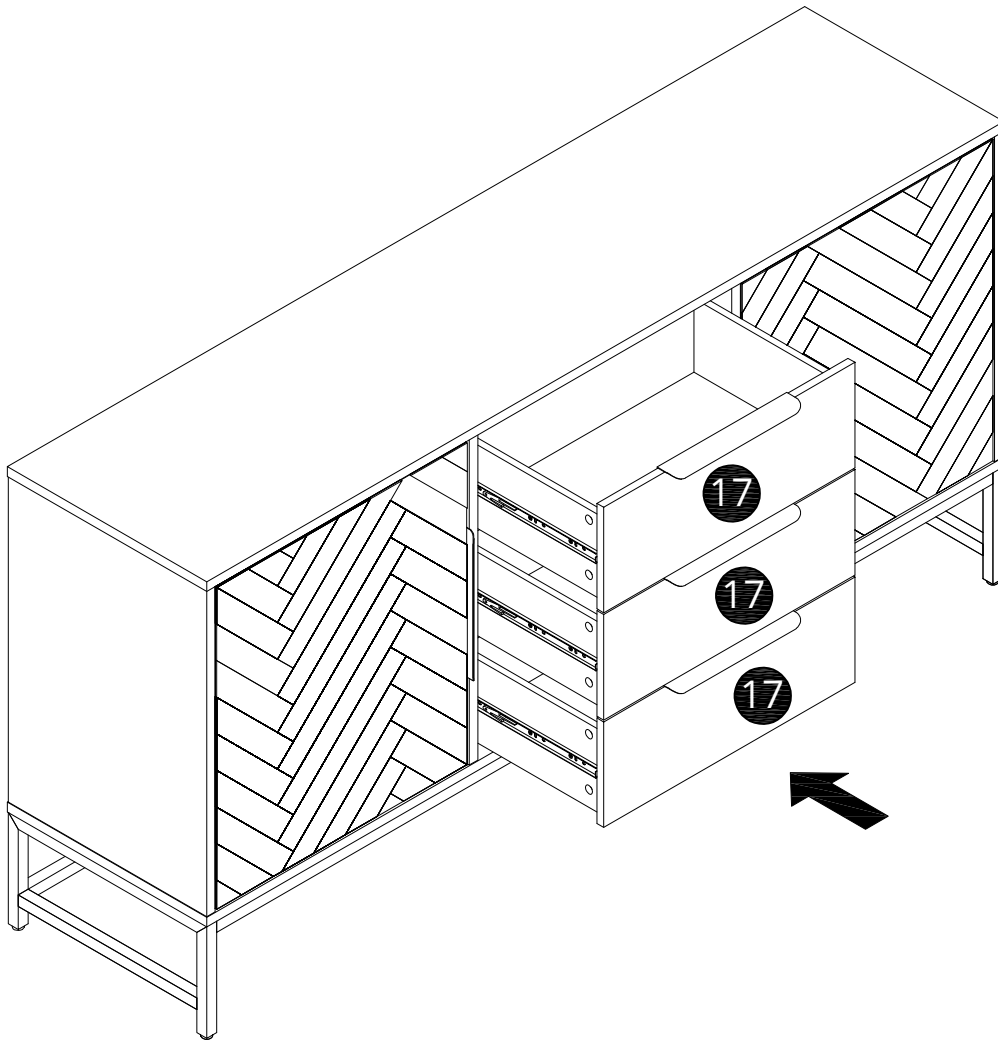
	80% X	
	100% ✓	





19



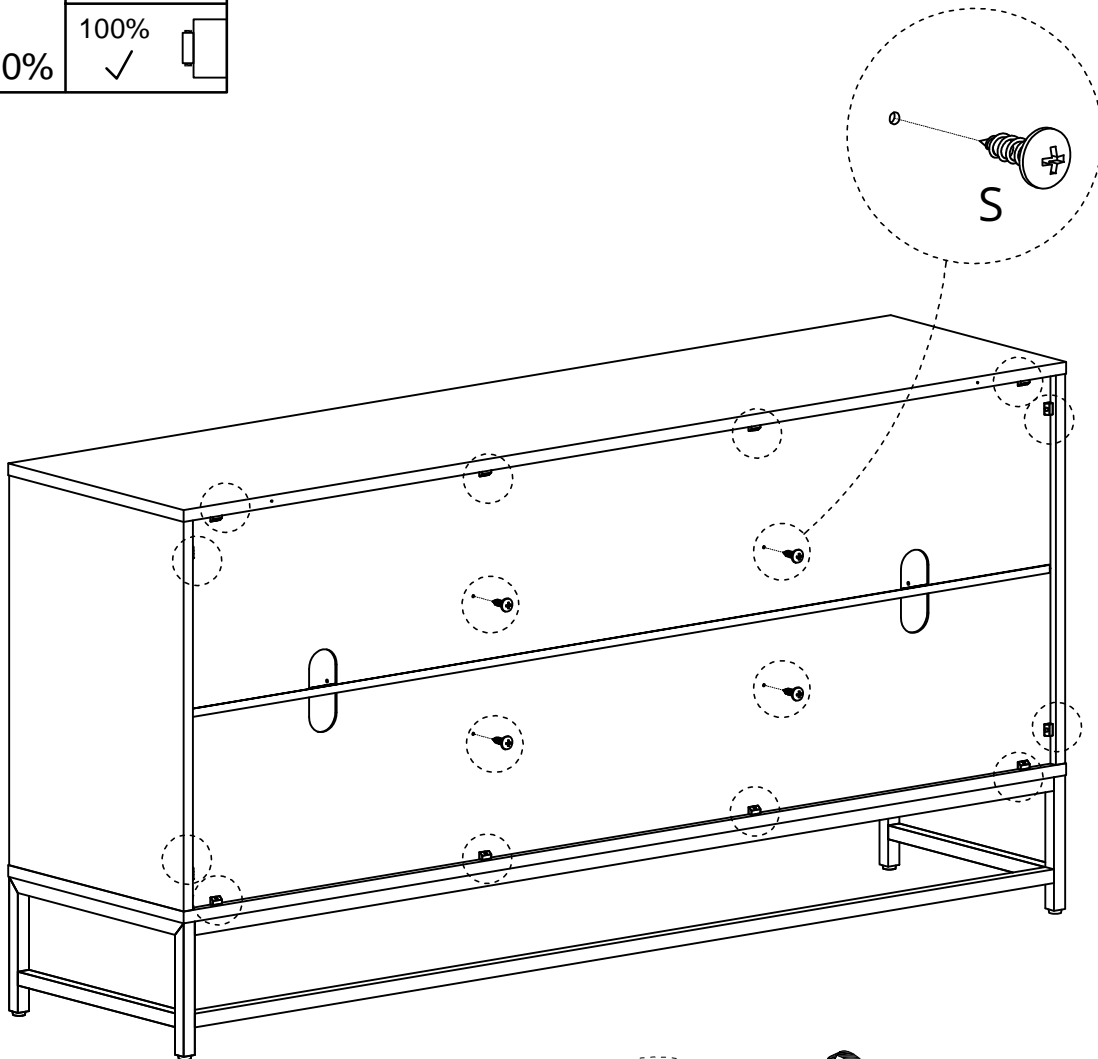

- R  x 12
- Q  x 12
- S  x 4

	80% X	
	100% ✓	

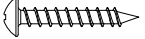

20

Anti-tipping-kit

V		x 2		x 2		x 2
		x 4		x 2		

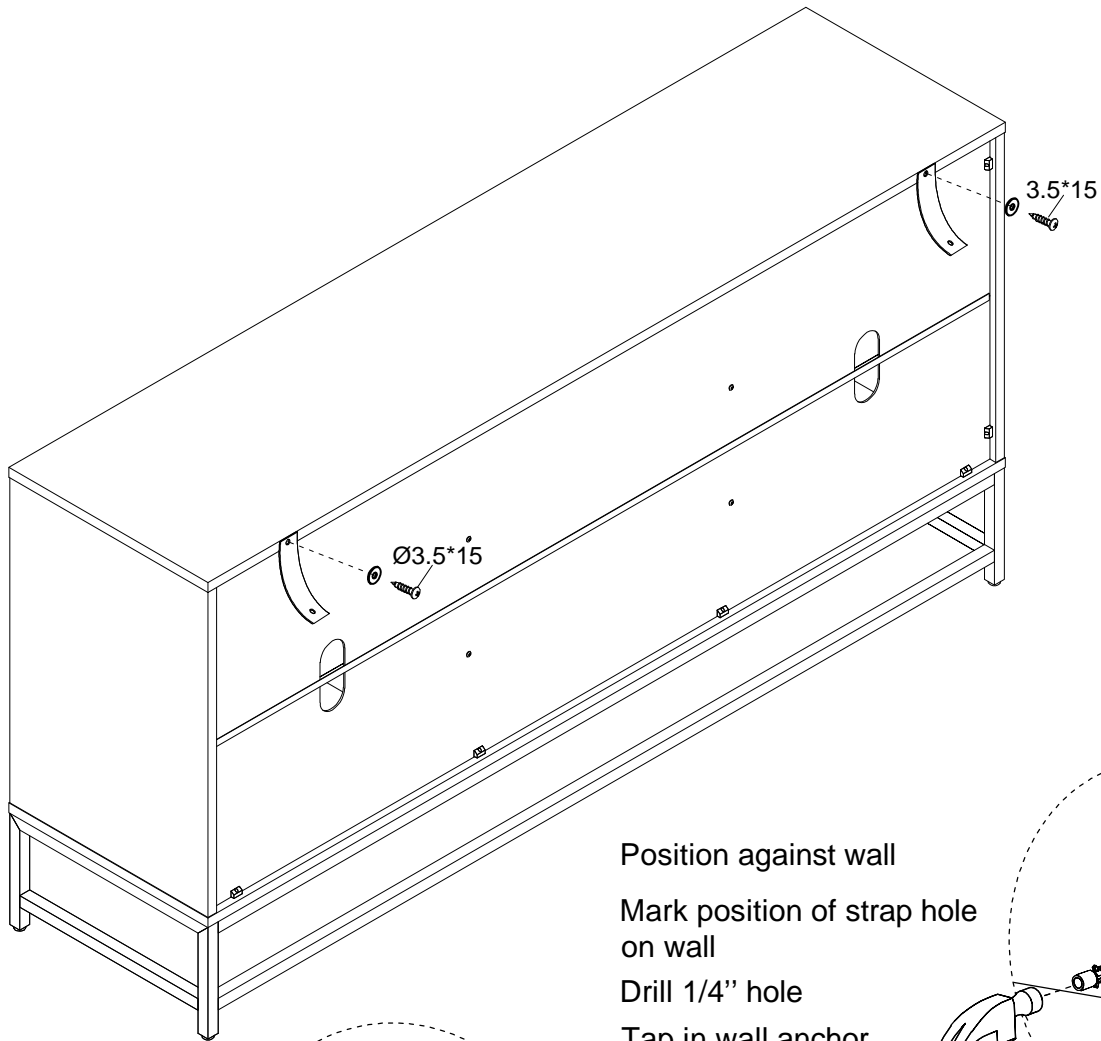

Position against wall
Mark position of strap hole
on wall
Drill 1/4" hole
Tap in wall anchor

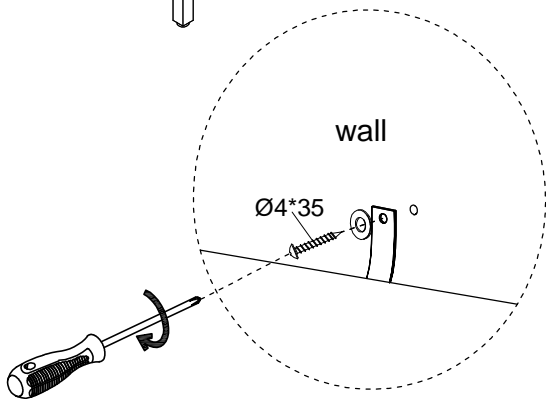
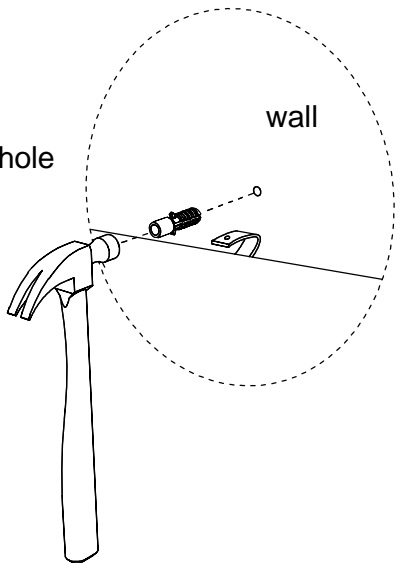

Fasten anti-tip strap
with Round-head screw provided

FINISHED

