

Slow Shelf 4

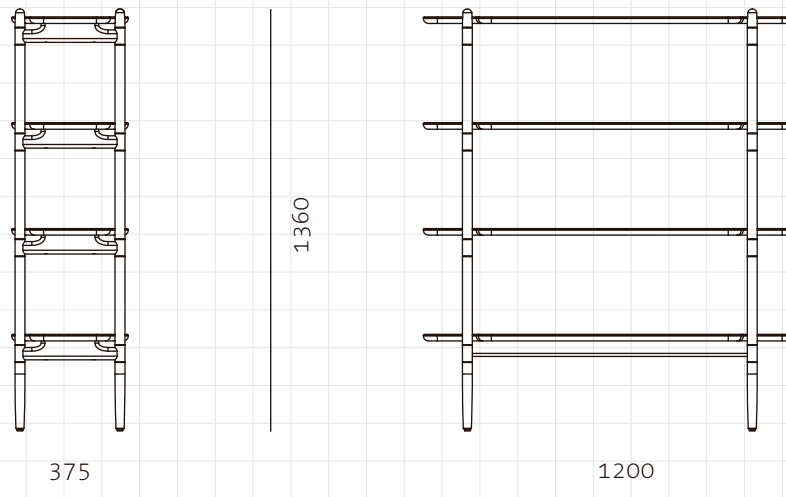

CODE
DIMENSIONS

SL-SF110-4
W1200 x D375 x H1360mm

NET WEIGHT
ENVIRONMENT
MATERIALS

28.0 kg
Indoor
Solid wood frame, Wood veneer shelves, Stainless steel oil rubbed copper
*Please refer to website or contact your local representative for complete material swatches.

SHIPPING

Package	Knock Down		
Package Qty	1 pcs/box		
Packaging	Measurement (mm)	Volume (cbm)	Gross Weight (kg)
FCL	W1300 x D440 x H460	0.26	31.96
LCL/AIR	W1340 x D480 x H550	0.35	39.43