

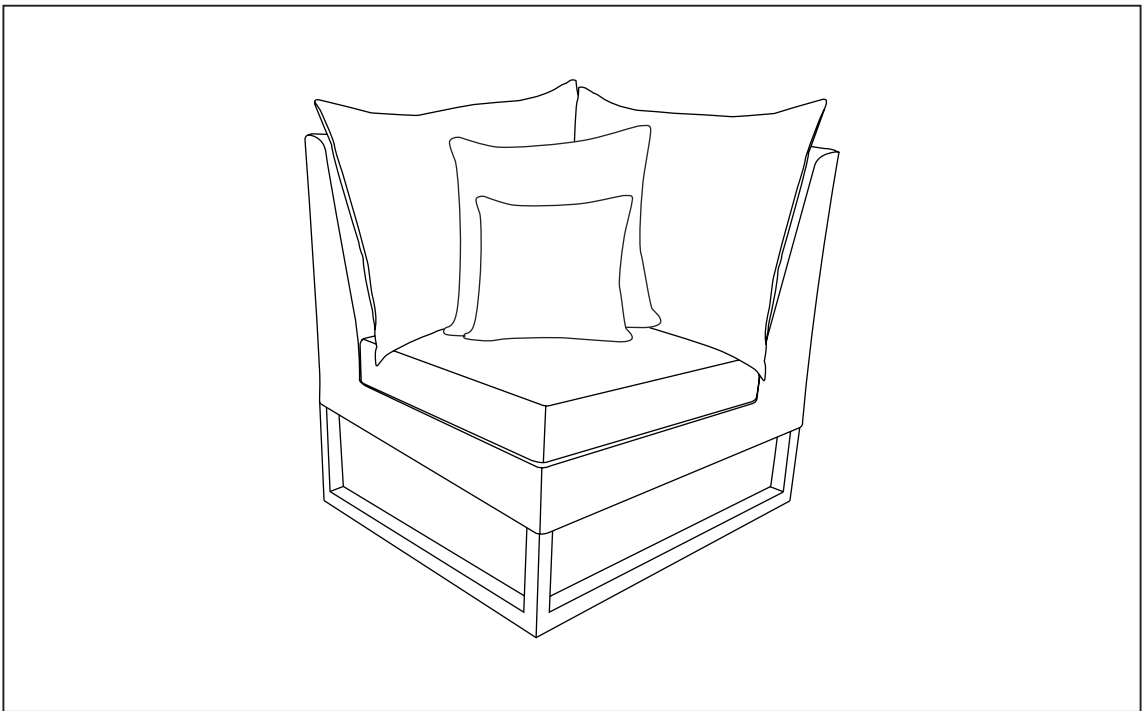



Corner chair

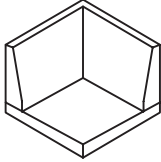
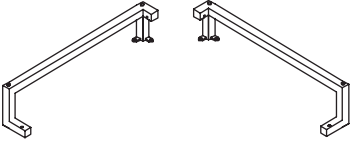

ASSEMBLY INSTRUCTIONS

**IMPORTANT, RETAIN FOR FUTURE REFERENCE.
READ CAREFULLY.**

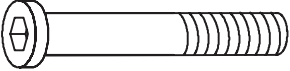
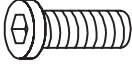
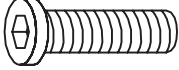
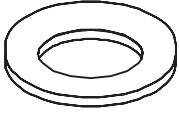
PARTS LIST

NO.	PICTURE	PART DESCRIPTION	QTY.
A		Corner chair	1
B		Chair legs	2
C		Support bar	2
D		Bolt (M6*50)	3
E		Bolt (M6*15)	2
F		Bolt (M6*25)	2
G		Washer (ø15*ø8.5*1.5)	7
H		#4 Allen wrench	1

Step 1.

ASSEMBLE CORNER CHAIR LEGS - Insert each side of support bars (C) into both chair legs (B). Use washers (G) and bolts (F) to secure chair legs together using the allen wrench (H).

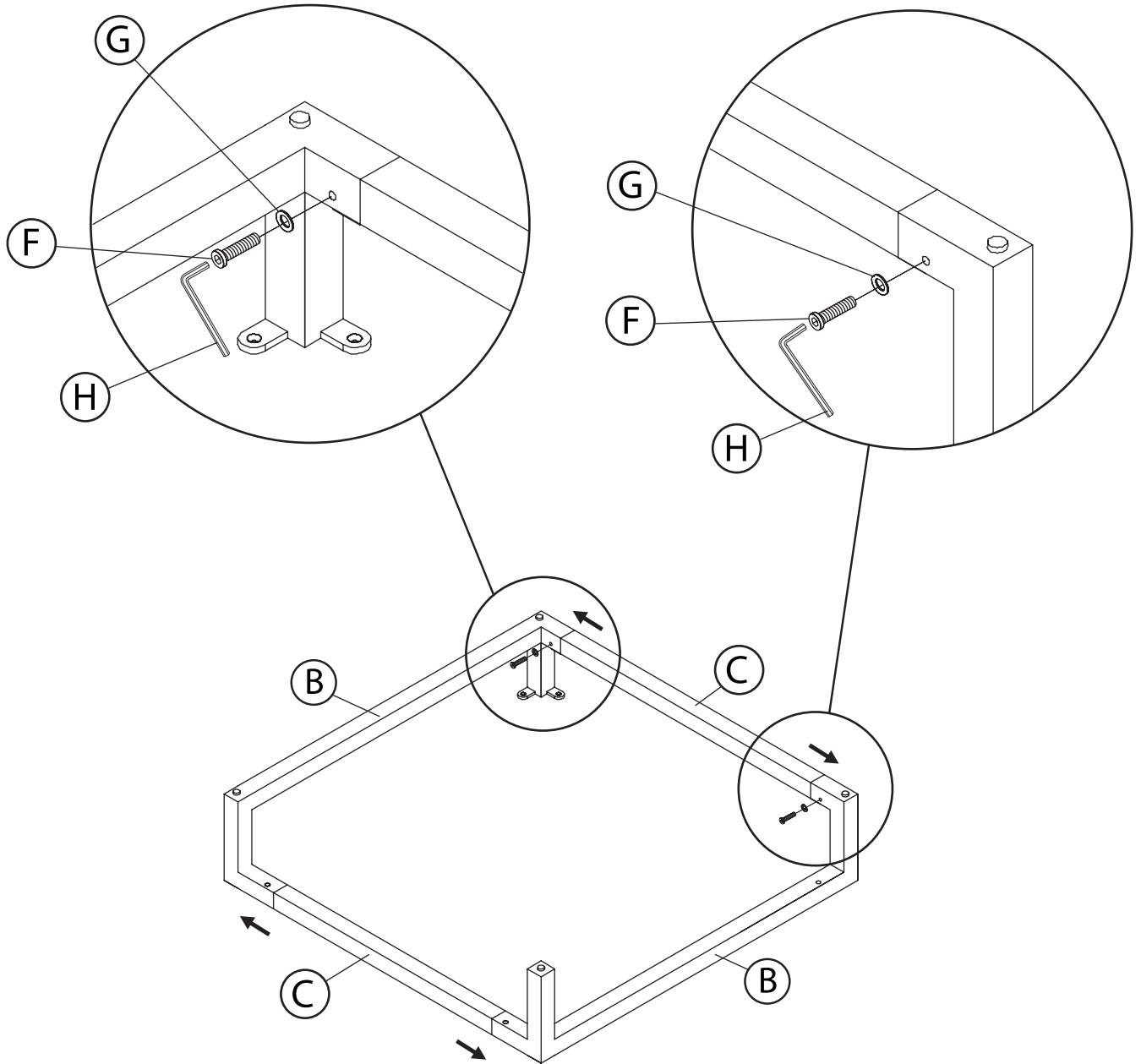

Step 2.

ATTACH CORNER CHAIR - With corner chair (A) upside down, attach the front foot of the chair legs using washers (E), bolts (G), and Allen wrench (H). Attach the rest of the legs to the chair with washers (F), bolts (D), and Allen wrench (G).

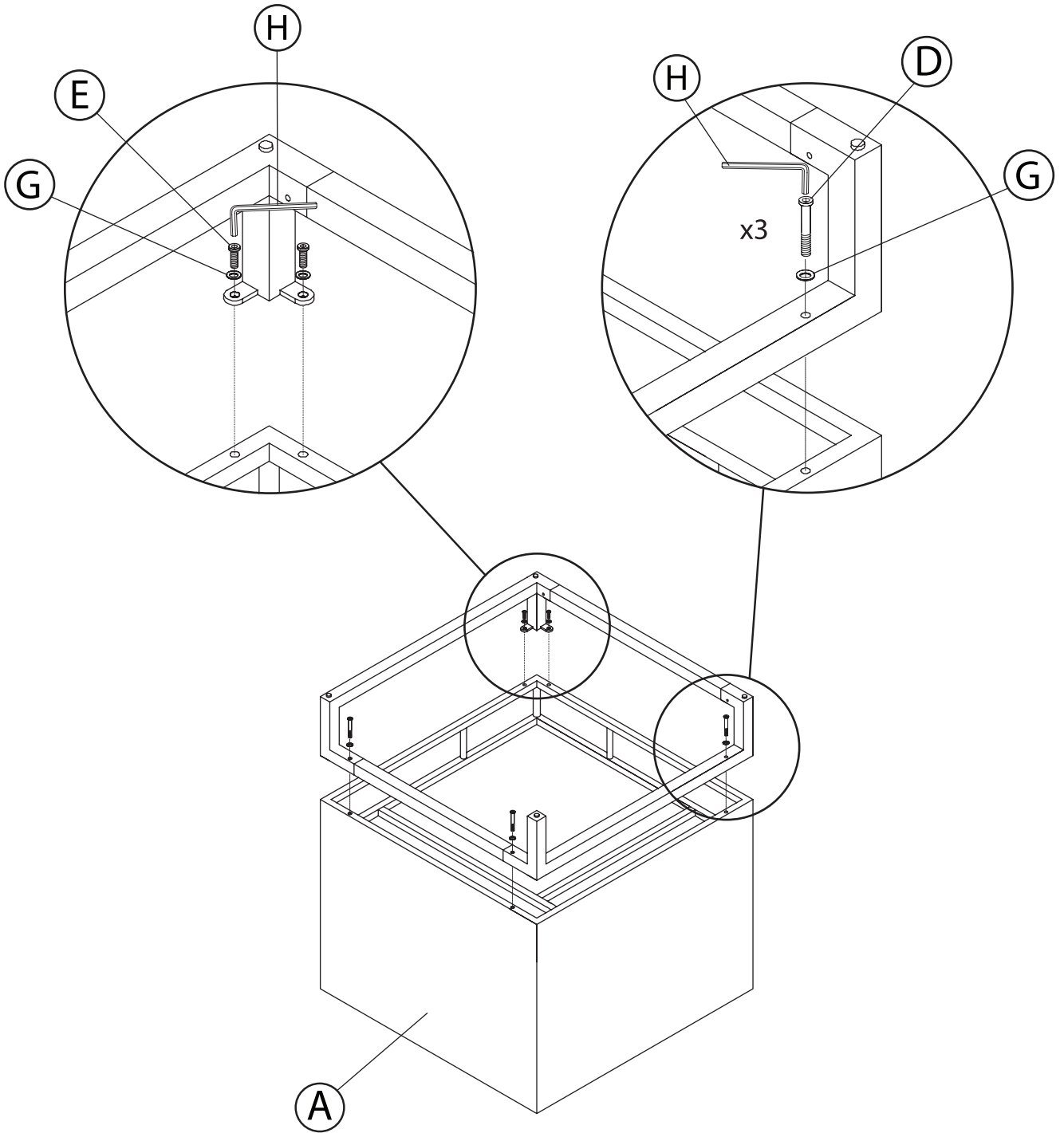

Care and Maintenance

All outdoor furniture is subject to UV rays and weather elements. In order to keep your furniture as long lasting and vibrant as possible, we advise using furniture covers or storing the furniture when not in use. For more information about the materials used to make our furniture please visit

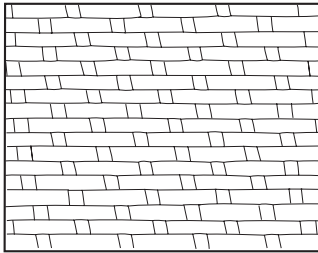

WICKER

Simply washing your wicker with a mild detergent and protecting it as much as possible by covering and or storing it when not in use for long periods of time is sufficient.

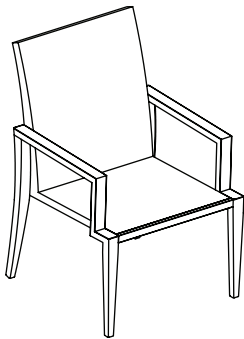

ALUMINUM FRAMES

RST Brands furniture incorporates aluminum powder coated frames that are designed to require minimum maintenance. Avoid letting too much dirt build up by cleaning with mild soap and water. Never leave furniture standing in water.

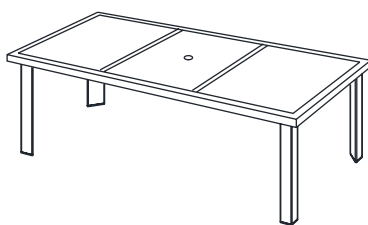

STONE TOPS/ TABLE TOPS

Spills should be wiped up quickly to avoid any staining on the surface. Regular cleaning with mild soap and water with a sponge or soft scrub brush is all that is required. Storing or covering your natural stone top when not in use for extended periods of time is recommended.

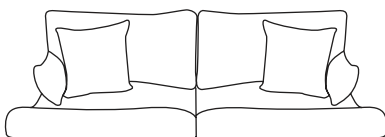

FABRICS

Wipe off spills with a cloth and water. Brands uses Sunbrella® fabrics designed to protect and last for several years. Sunbrella fabrics are treated with a proprietary water and stain repellent. If needed to revive fabrics Glen Raven® recommends 303® Fabric Guard™. For more information visit and follow instructions on the container.

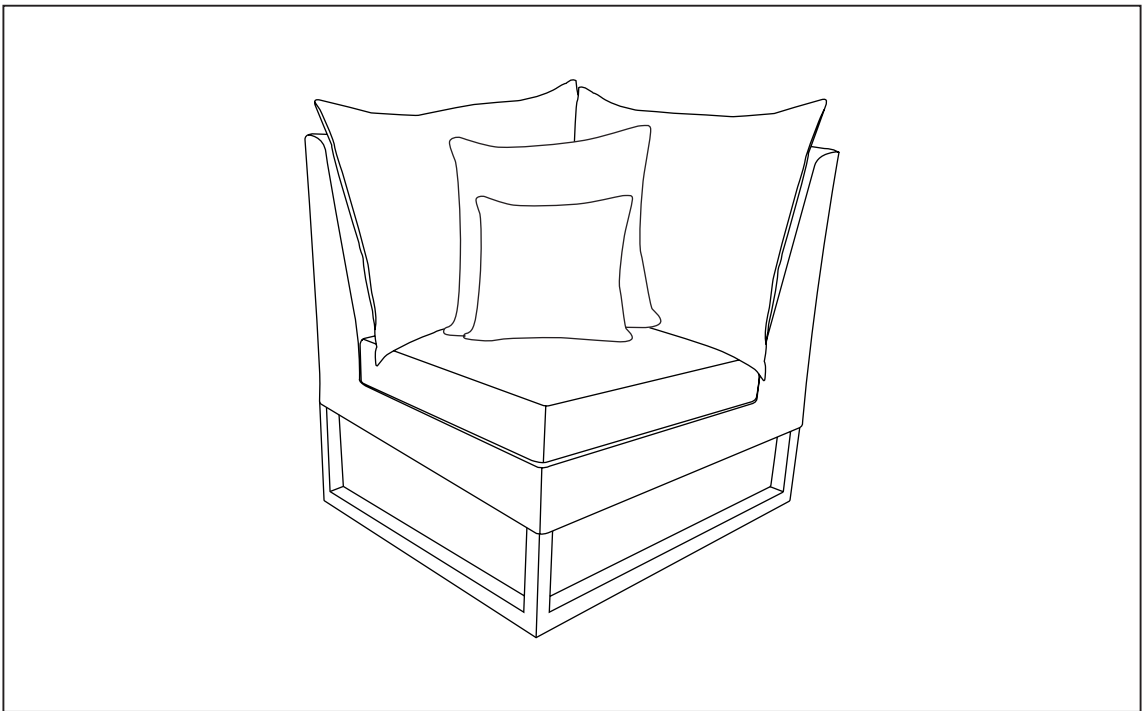

Chaise d'angle



INSTRUCTION D' ASSEMBLAGE

**ATTENTION, CONSERVER POUR CONSULTATION.
LIRE ATTENTIVEMENT.**

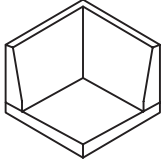
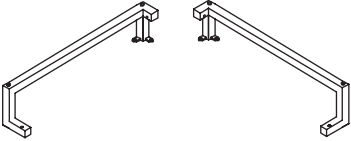
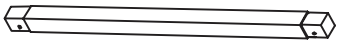
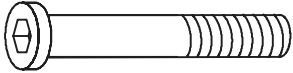
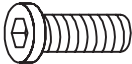
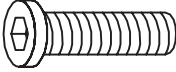
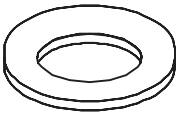
LISTE DES PIÈCES

NO.	IMAGE	RÉFÉRENCE DESCRIPTION	QTE.
A		Canapé d' angle	1
B		Pattes de canapé	2
C		Barre de support	2
D		Boulon (M6*50)	3
E		Boulon (M6*15)	2
F		Boulon (M6*25)	2
G		Rondelle (ø15*ø8.5*1.5)	7
H		#4 Clé Allen	1

Étape 1.

ASSEMBLE LES PATTES DE CHAISE D'ANGLE- Insérer les deux côtés des barres de support (C) dans les deux pattes de chaise (B). Utilisez les rondelles (G) et les boulons (F) pour fixer les pieds du chaise à l'aide de la clé Allen (H).

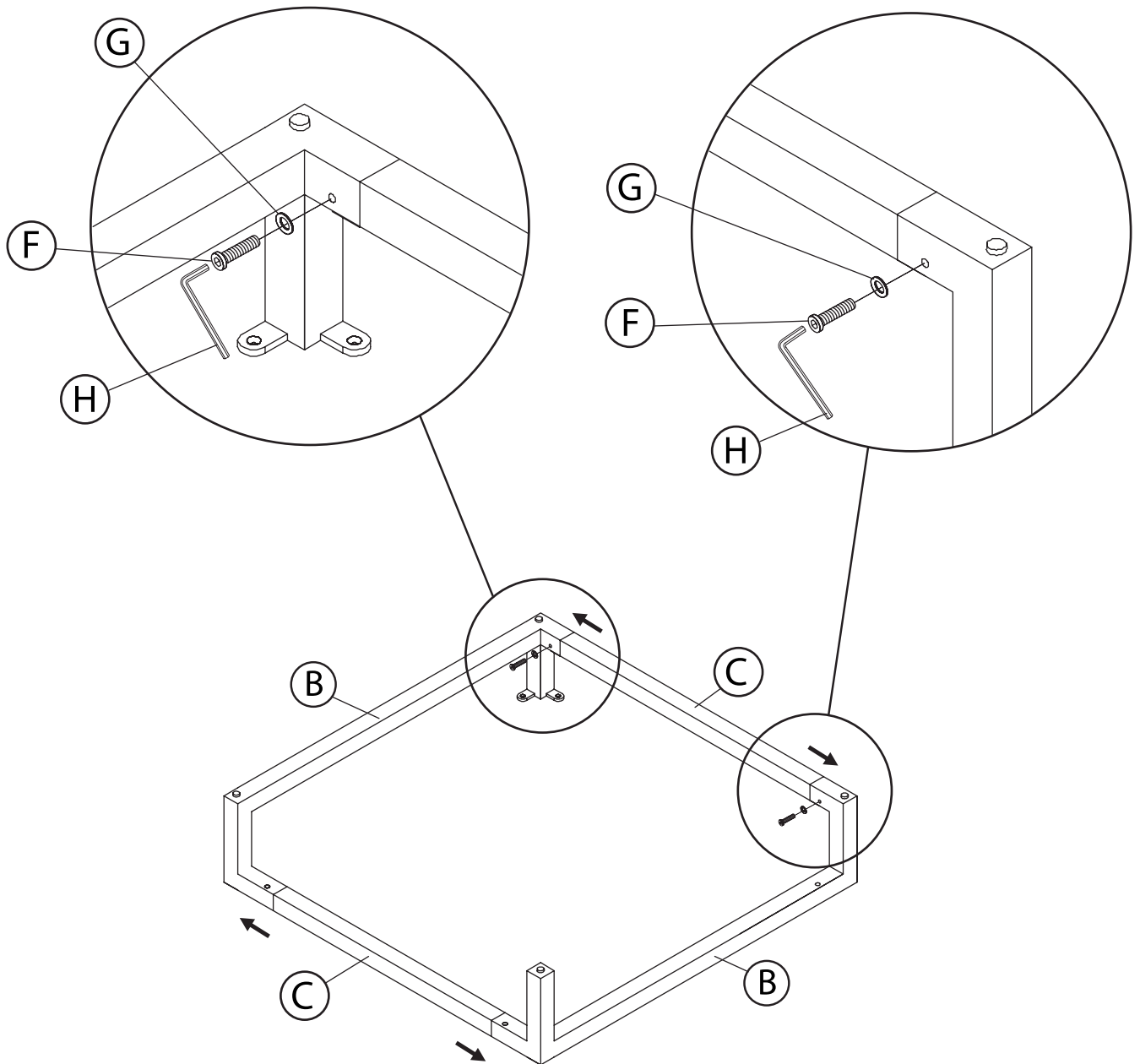

Étape 2.

ATTACHER LES PATTES DE CHAISE D'ANGLE- Avec le chaise d'angle (A) à l'envers, fixez le pied avant des pattes du chaise en utilisant les rondelles (E), les boulons (G) et la clé Allen (H). Fixez le reste des pieds au chaise avec les rondelles (F), les boulons (D) et la clé Allen (G).

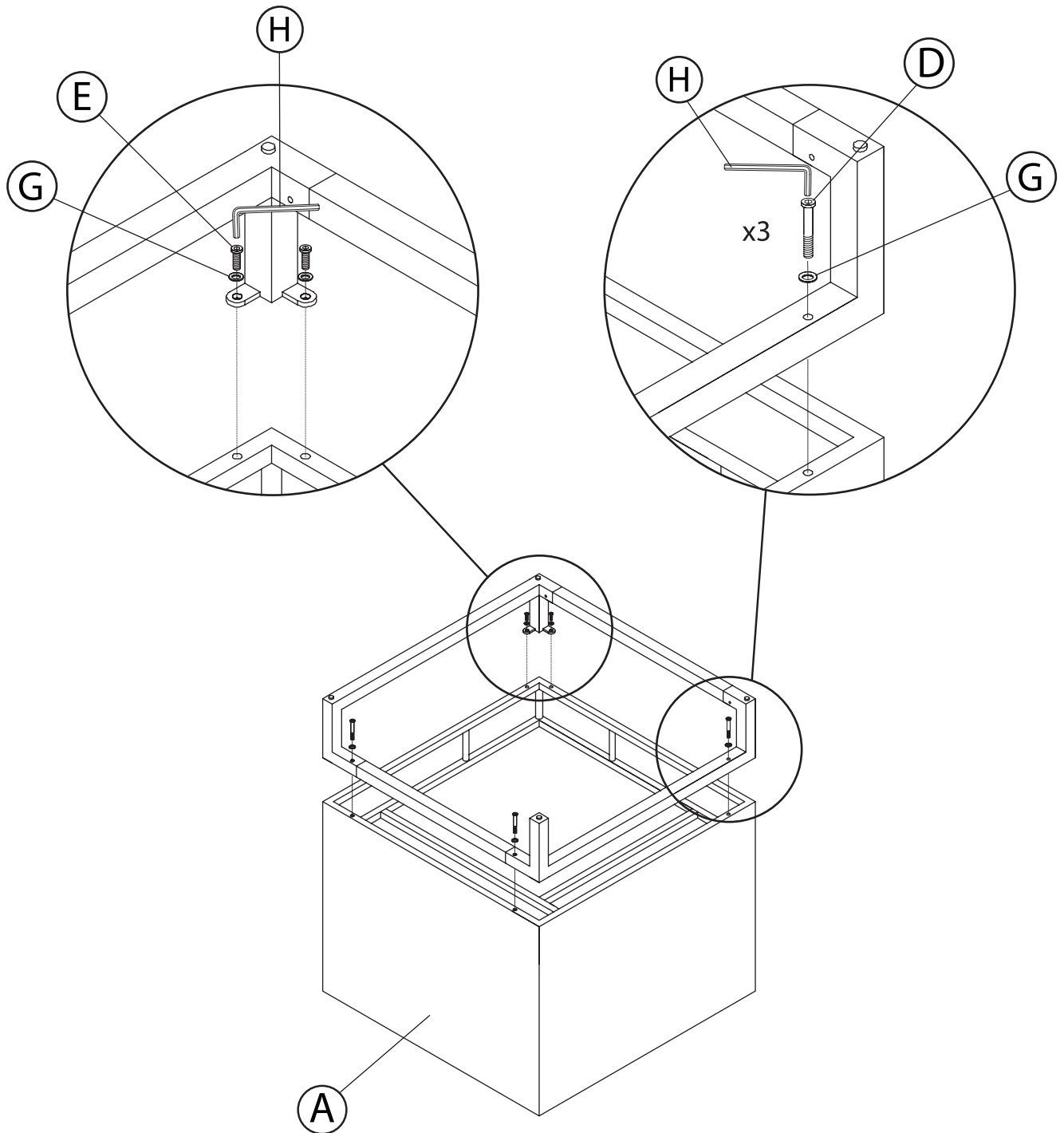

Soins et Entretien

Tout meuble à l'extérieur est soumis aux rayons UV ainsi qu'aux éléments météorologiques. Afin de préserver vos meubles aussi longtemps et aussi vibrants que possible, nous vous conseillons de les couvrir ou de les garder à l'intérieur lorsqu'ils ne sont pas utilisés. Pour plus d'informations sur les matériaux utilisés pour fabriquer nos meubles, veuillez visiter

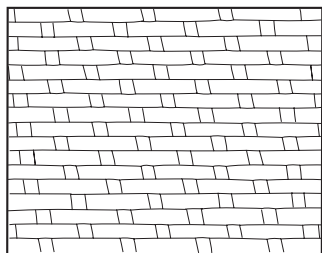

OSIER

Laver simplement vos meubles en osier avec un détergent léger, en les protégeant autant que possible en les couvrant ou en les gardant à l'intérieur lorsqu'ils ne sont pas utilisés, est suffisant.

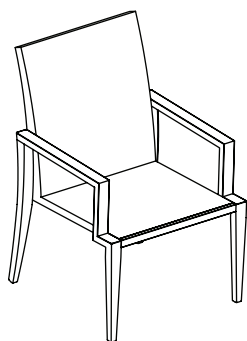

CADRES EN ALUMINIUM

Les meubles RST Brands incorporent des cadres recouverts en aluminium qui sont conçus pour nécessiter un entretien minimum. Évitez de laisser trop de poussière s'empiler en les lavant avec du savon doux et de l'eau. Ne laissez jamais de meuble sous l'eau.

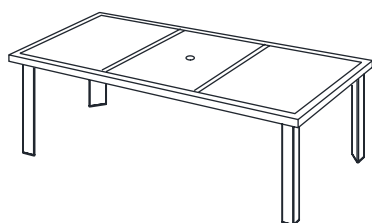

SURFACES EN PIERRE / DESSUS DE TABLE

Les liquides renversés doivent être nettoyés rapidement pour éviter toute tache sur la surface. Un lavage régulier avec un savon doux et de l'eau en utilisant une éponge ou une brosse souple est l'unique chose requise. Ranger ou couvrir votre surface en pierres naturelles lorsque'elle n'est pas utilisée pendant une durée étendue est recommandé.

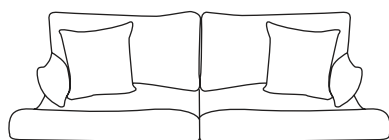

TISSUS

Nettoyez les liquides renversés avec un tissu et de l'eau. RST Brands utilise Sunbrella®, conçu pour protéger et durer pendant plusieurs années. Les tissus Sunbrella sont traités avec de l'eau et du produit ante-taches. Si nécessaire pour faire revivre les tissus, Glen Raven® recommande 303® Fabric Guard™. Pour plus d'informations, visiter et suivre les instructions présentes sur le conteneur.



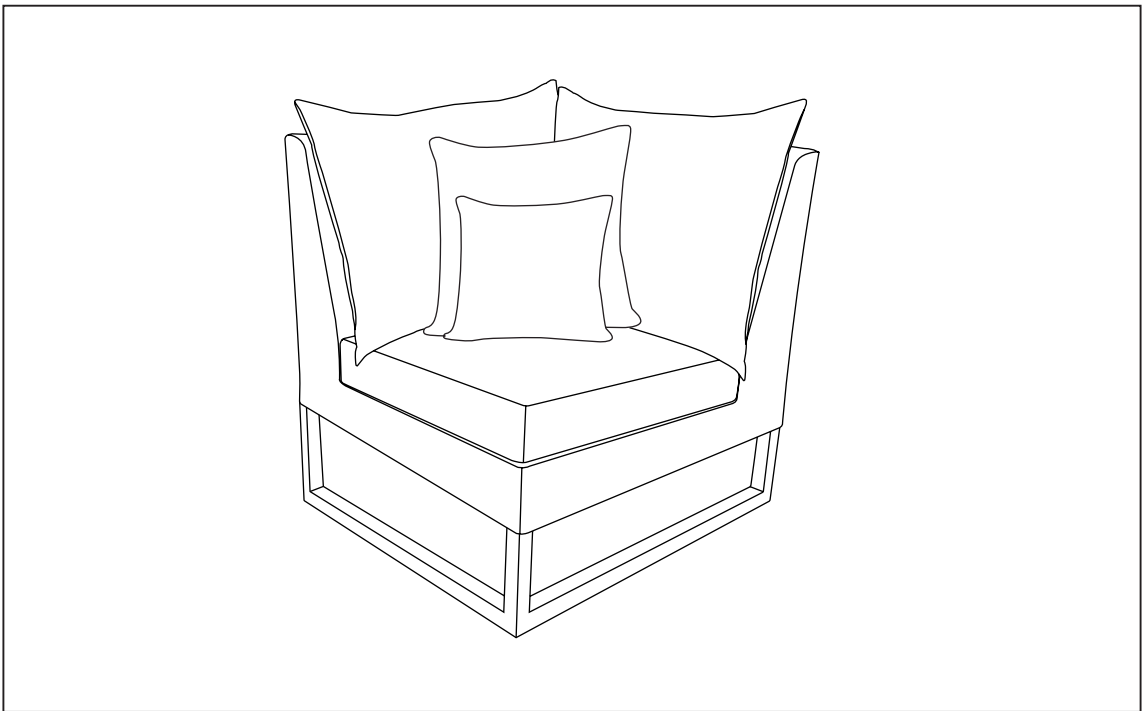

Silla de esquina

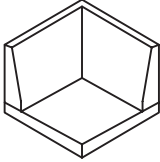
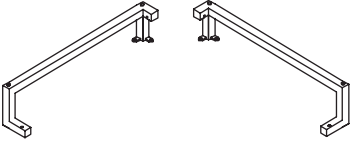

MANUAL DE INSTRUCCIONES Y ENSAMBLE

**IMPORTANTE, RETENER PARA FUTURAS CONSULTAS.
LEA CUIDADOSAMENTE**

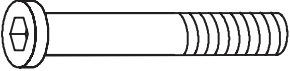
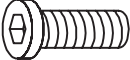
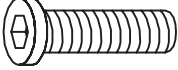
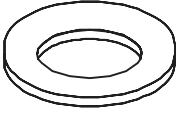
LISTA DE PARTES

NO.	IMAGEN	DESCRIPCIÓN (PARTE)	CANT.
A		Silla de esquina	1
B		Patas de la silla de esquina	2
C		Barra de soporte	2
D		Perno (M6*50)	3
E		Perno (M6*15)	2
F		Perno (M6*25)	2
G		Arandela (ø15*ø8.5*1.5)	7
H		#4 Llave Allen	1

Paso 1.

ENSAMBLAR LAS PATAS DE LA SILLA DE ESQUINA - Conectar cada lado de las barras de soporte (C) en ambas patas de la silla de esquina (B). Usa arandelas (G) y pernos (F) para unir las patas de la sofá de esquina con la llave Allen (H).

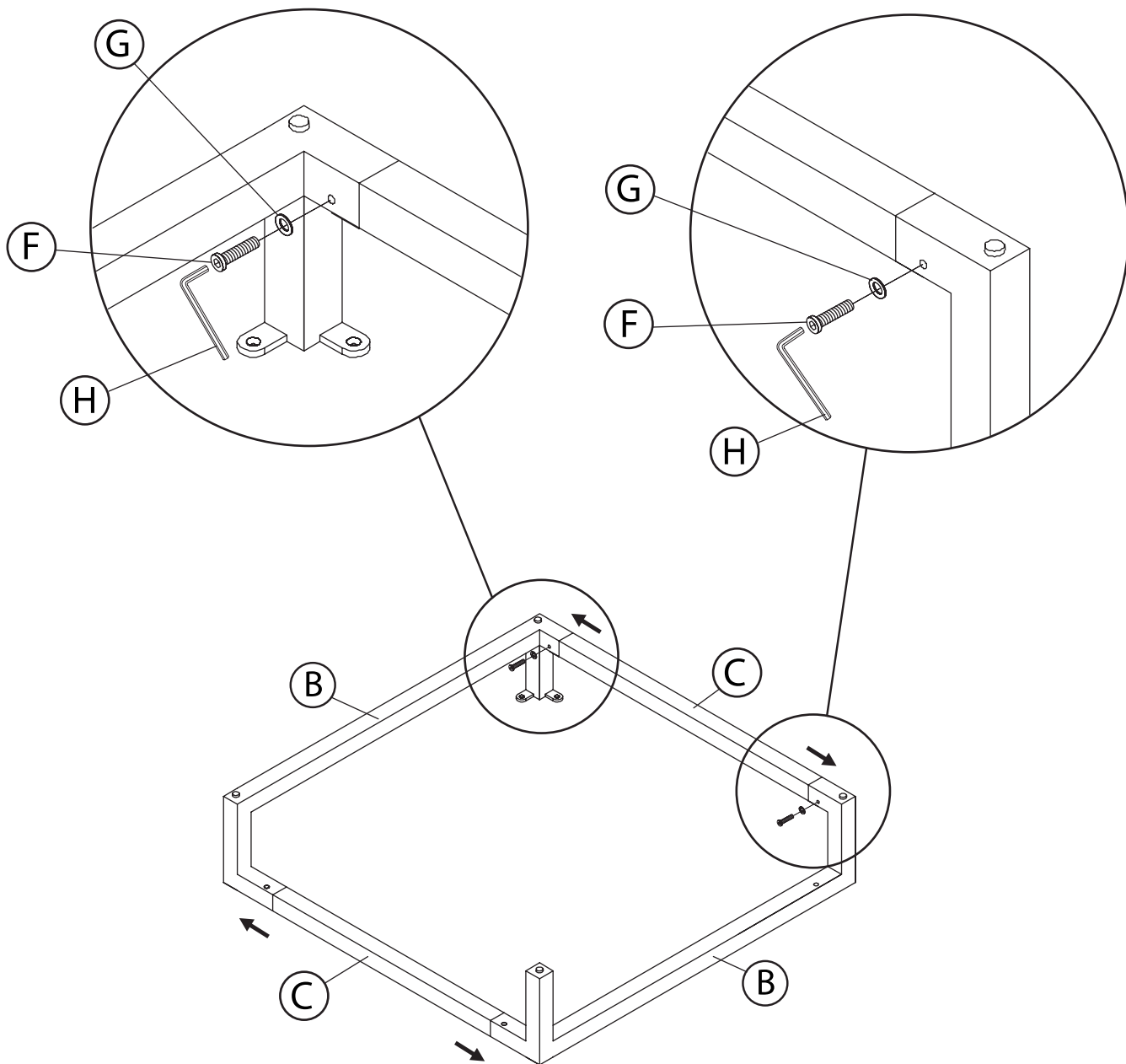

Paso 2.

SUJETAR LAS PATAS DE LA SILLA DE ESQUINA- Con la silla de esquina (A) boca abajo, sujete la pata del frente de la silla usando arandelas (E), pernos (G) y la llave Allen (H). Sujete el resto de las patas de la silla con arandelas (F), pernos (D), y la llave Allen (G).

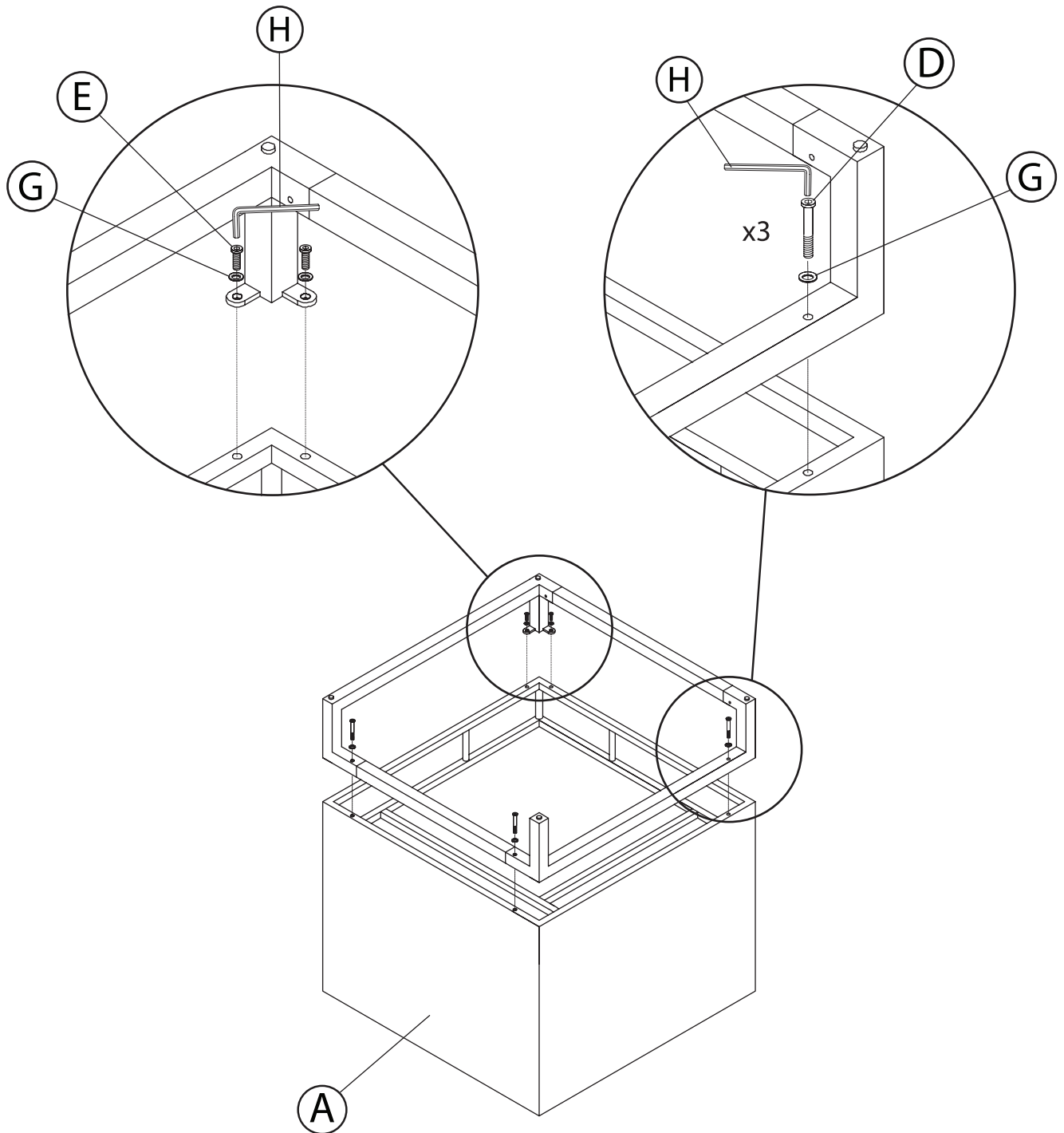

Cuidados y Mantenimiento

Todo mobiliario al aire libre está sujeto a los rayos ultravioleta y las inclemencias meteorológicas. Para que sus muebles duren y los colores se mantengan tan vibrantes como sea posible, aconsejamos cubrirlos o guardarlos cuando no estén en uso. Para obtener más información acerca de los materiales utilizados para fabricar nuestros muebles visite

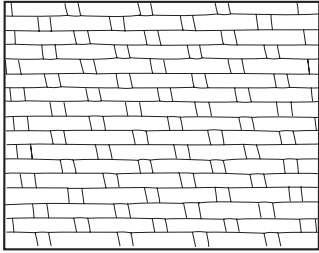

MIMBRE

Simplemente lave sus muebles de mimbre con un detergente suave y protéjalos cubriéndolos o guardándolos cuando no los use durante largos períodos de tiempo.

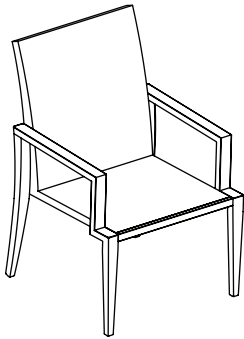

ESTRUCTURAS DE ALUMINIO

Los muebles de RST Brands están contruidos con estructuras recubiertas con polvo de aluminio diseñados para necesitar mantenimiento mínimo. Evite que se acumule demasiada suciedad limpiando con agua y jabón suave. Nunca deje muebles sobre el agua.

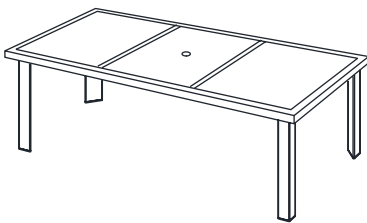

SUPERFICIES DE PIEDRA / MESA

Limpie los derrames rápidamente para evitar manchas en la superficie. La limpieza regular con agua y jabón suave con una esponja o cepillo es todo lo que se necesita. Se recomienda almacenar o cubrir la superficie de piedra natural cuando no está en uso durante períodos prolongados de tiempo.

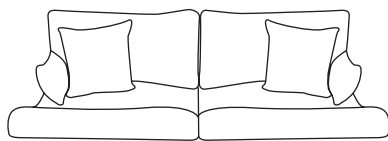

TEJIDOS

Limpie los derrames con un paño y agua. Brands utiliza tejidos Sunbrella® que están diseñados para proteger y durar varios años. Los tejidos Sunbrella se tratan con un repelente de agua y manchas de fórmula patentada. Si es necesario para reavivar los tejidos Glen Raven® se recomienda usar 303© Fabric Guard™. Para obtener más información, visite y siga las instrucciones en el envase.