

# Assembly Instructions

## TABLE

**CAUTION:** You must read this before you proceed.

**Please look under the Table Top for hardware pack.**

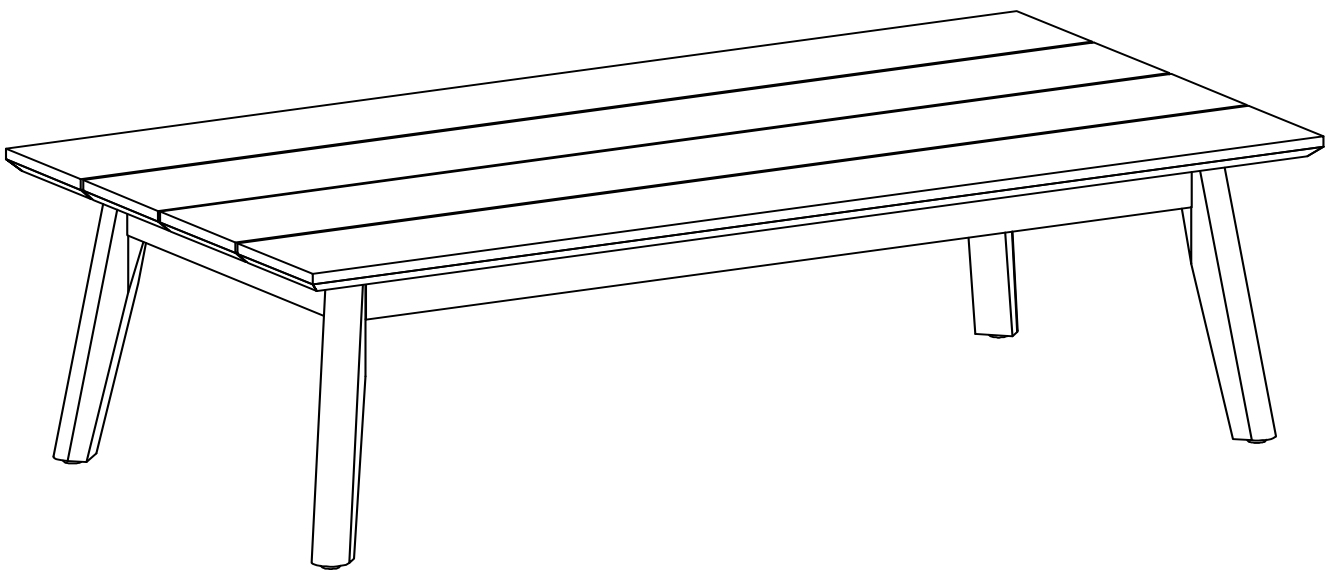

**CAUTION :** This Table is NOT a TOY.



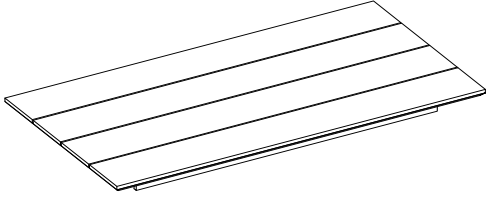
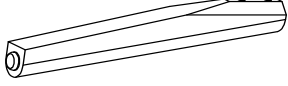

Keep your child / children at bay in the process of assembly.

For turning the Table and to prevent damage to the Table, 02 persons may be needed to execute this action.

## Parts List

No.	Picture	Description	Qty
<b>G</b>		Table Top	1
<b>H</b>		Leg	4

## Hardware

Label	Picture	Description	QTY
⑤		Bolt (M6 x 50mm)	9
⑥		Spring Washer	9
⑦		Washer	9
⑧		Allen Wrench	2

## Assembly Preparation

Before Beginning Assembly:

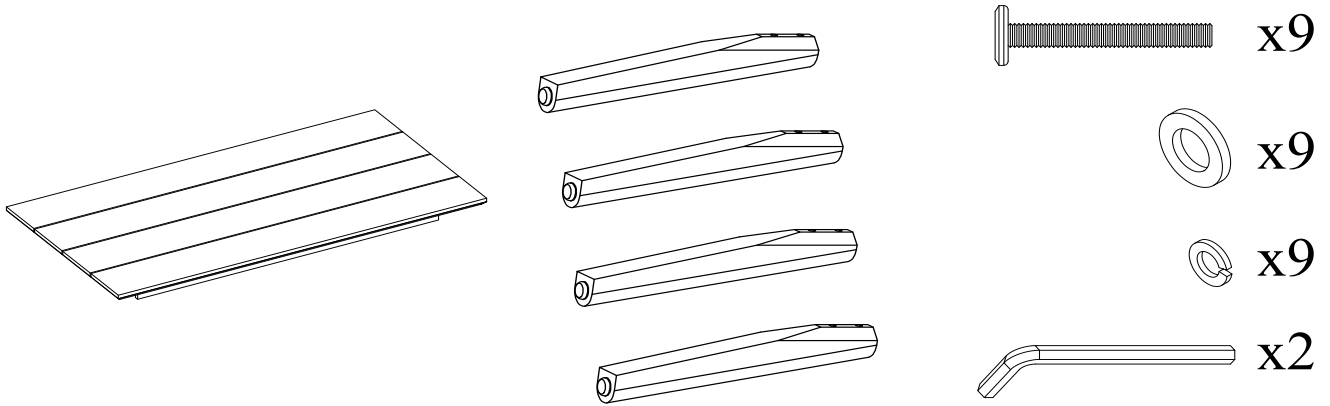

Read instructions, cover to cover.



Have 2 adults on hand for assembly.



Do not assemble on flooring or carpet.



Assemble on a clean non-marring surface (packing foam).



Save all packaging until finished.

## Assembly Steps

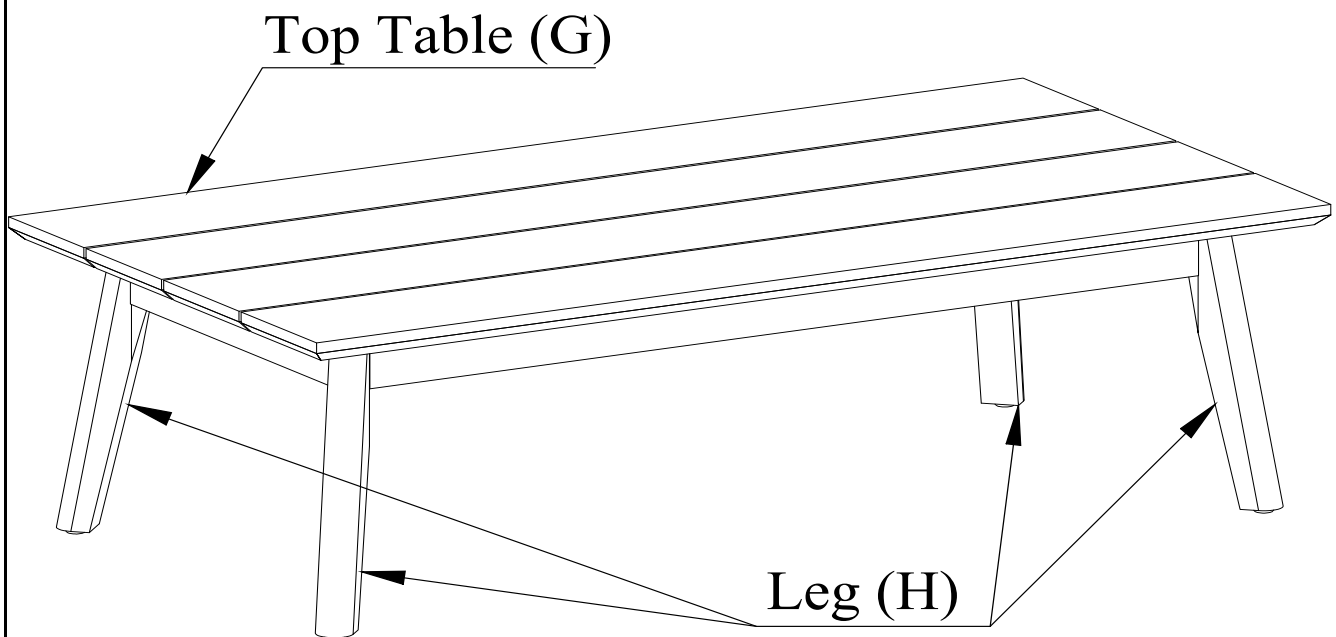

This Table has multiple parts and may require up to 30 minutes to assemble. To give you an overview of the Table parts, the above picture is to help you put the various parts into perspective. Please read through the instructions herebelow to familiarise yourself with the parts and steps before assembly.

### Step 1

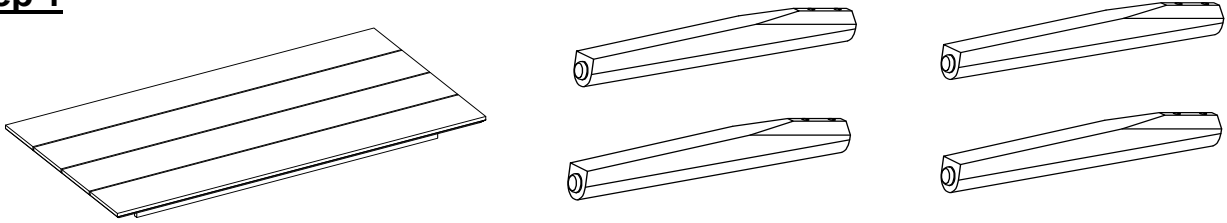

Unpack and place all parts on a clean, non-marring surface.

### Step 2

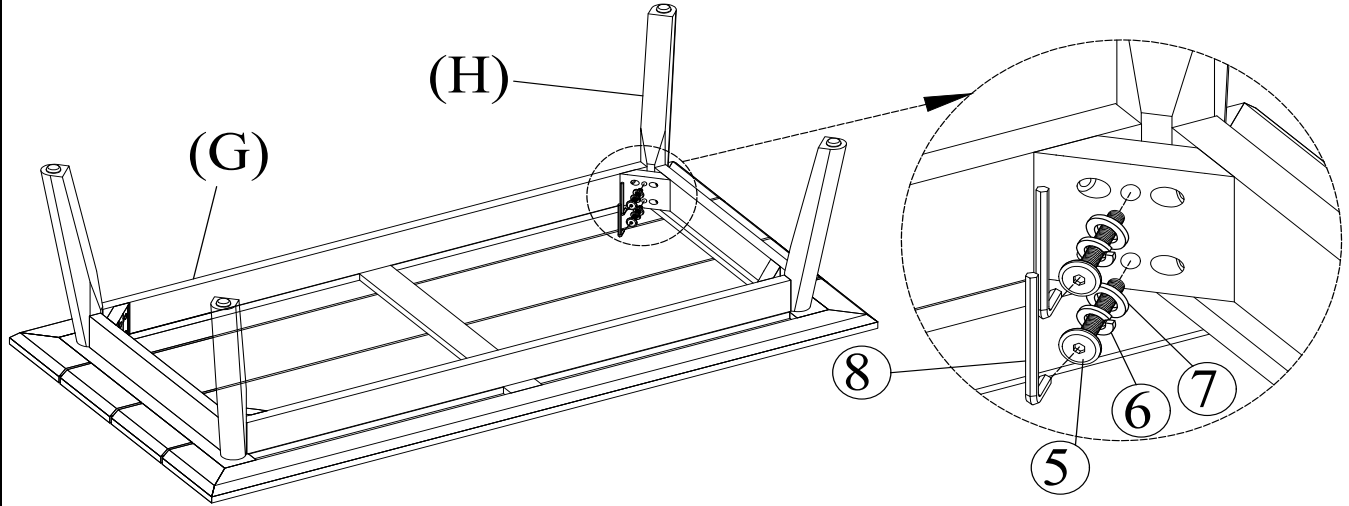

Place the Table Top (G) facedown on a clean, non-marring surface as shown above  
Attach the Leg (H) to the Table Top (G) using Spring Washers (6), Washers (7), Bolts (5) and the Allen Wrench (8) as shown above.

Repeat the same process with the three remaining Legs (H)

**Do not fully tighten the Bolts**

### Step 3

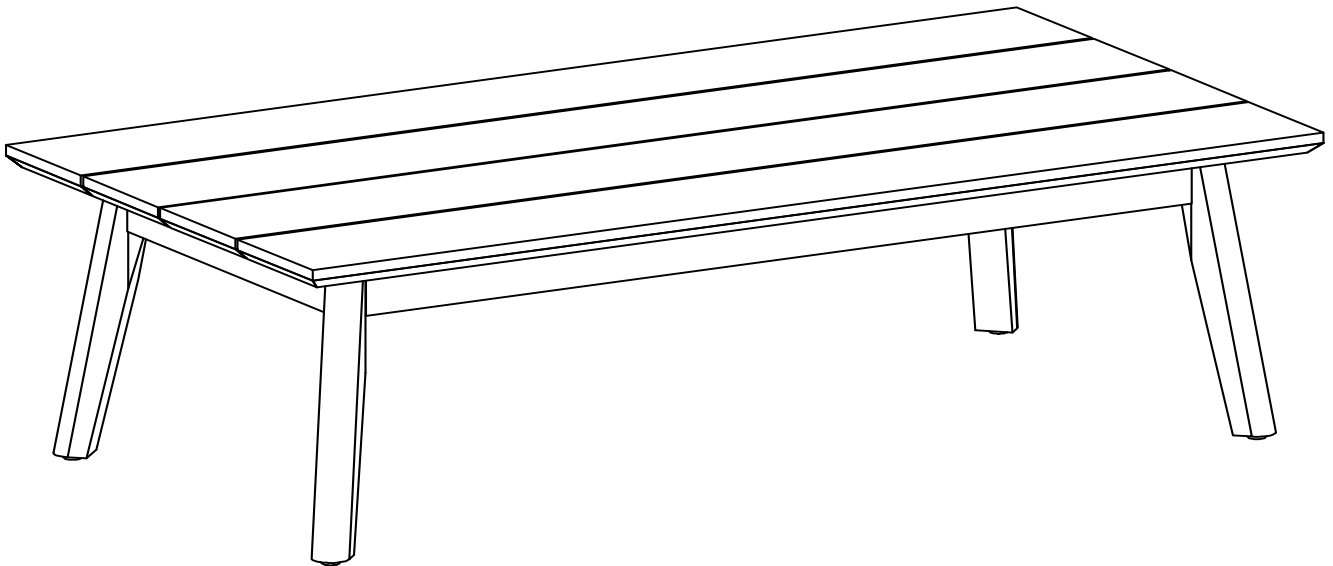

Turn the Table right side up.

EXERT pressure, floorwards onto the Table with both hands.

This pressure will help the Table reach full alignment at all joints.



















In a sequential manner, gradually tighten all Bolts at all joints until evenly secured.

Inspect the Table and make sure all parts are adequately connected.

**Your Table is ready for use.**

**This Table can only be used on a flat, level surface.**

## Care & Maintenance

-   ● Do not put hot items directly on furniture surface
-   ● Do not clean furniture with harsh cleansers or polish.
-   ● To obtain the longest lifespan of your outdoor products, minimizing exposure to direct sunlight is recommended.
-   ● Children should not climb or jump on the furniture.
-   ● Do not write on furniture without a padded barrier to protect the surface.
-   ● To obtain the longest lifespan of your outdoor products, avoid extended and lengthy exposure to rain, snow, and direct sunshine. Whenever possible cover the product and /or place under patio or awnings.
-   ● Not for commercial use. For residential use only .
-   ● Stains may be removed with mild soap solution and damp cloth.
-   ● Dust and pick-up spills using a clean, non-colored, lint-free cloth.