

ASSEMBLY INSTRUCTION FOR ACME FURNITURE

MODEL#BD00687



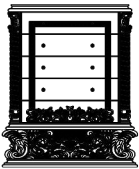

Thank you for purchasing the quality product. Be sure to check all packing material carefully for small parts which may have come loose inside the carton during shipment. Separate, identify and count all parts and metal hardware. Compare with all parts list to be sure all parts are present. If any part(s) are missing or damaged, please contact your local furniture dealer. For efficient and speedy service, please indicate the model number and code letter of part(s) needed.

*** Do not fully tighten screws until fully assembled ***

PARTS LIST

NO	DESCRIPTION	SKETCH	QTY
A	CHEST		1PCS

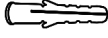
HARDWARE LIST

NO	DESCRIPTION	SKETCH	QTY
1	FASTEN UNIT 44mmX20mm		4 PCS
2	LONG SCREW Ø7mmX28mm		4 PCS
3	SHORT SCREW Ø6mmX16mm		4 PCS
4	SHRINK BOLT Ø5/16"X1-1/2"		4 PCS
5	SAFTY BELT 8mmX250mm		2 PCS

How to assemble:

STEP 1

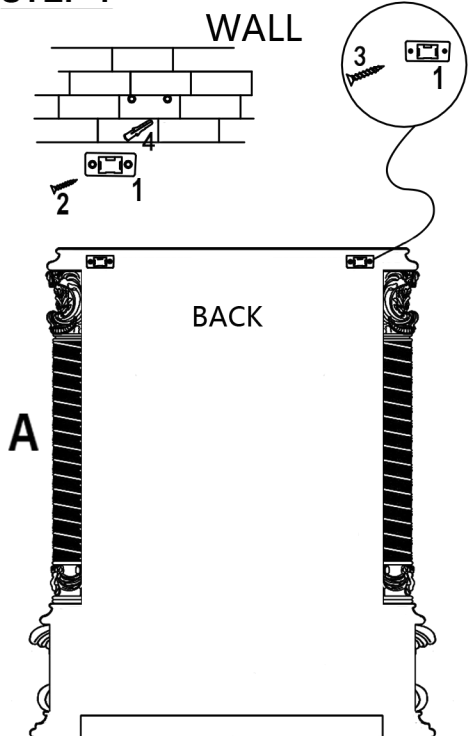

STEP 2

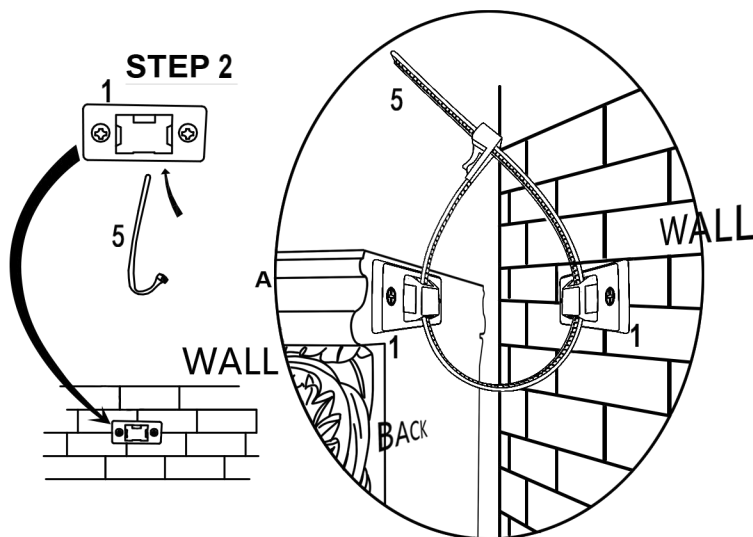

STEP 3

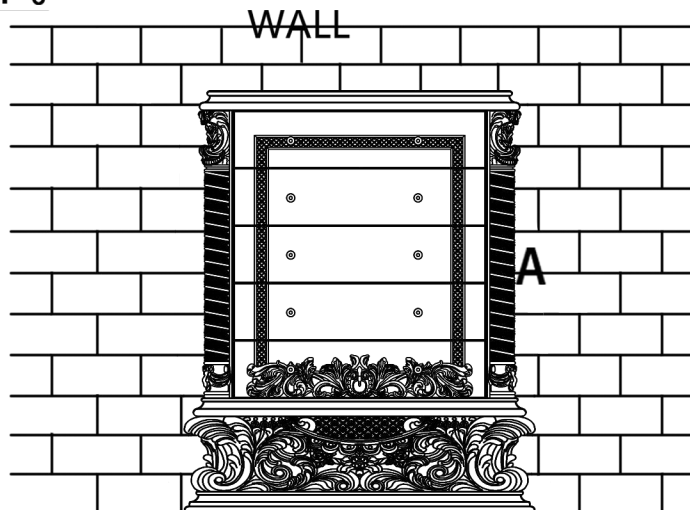

COMPLETED

MADE IN CHINA