

10×10 Hardtop BBQ Gazebo

If you have any questions about the outdoor gazebo, please feel free to contact us.

Customer Service Email: Service@alaulm.com

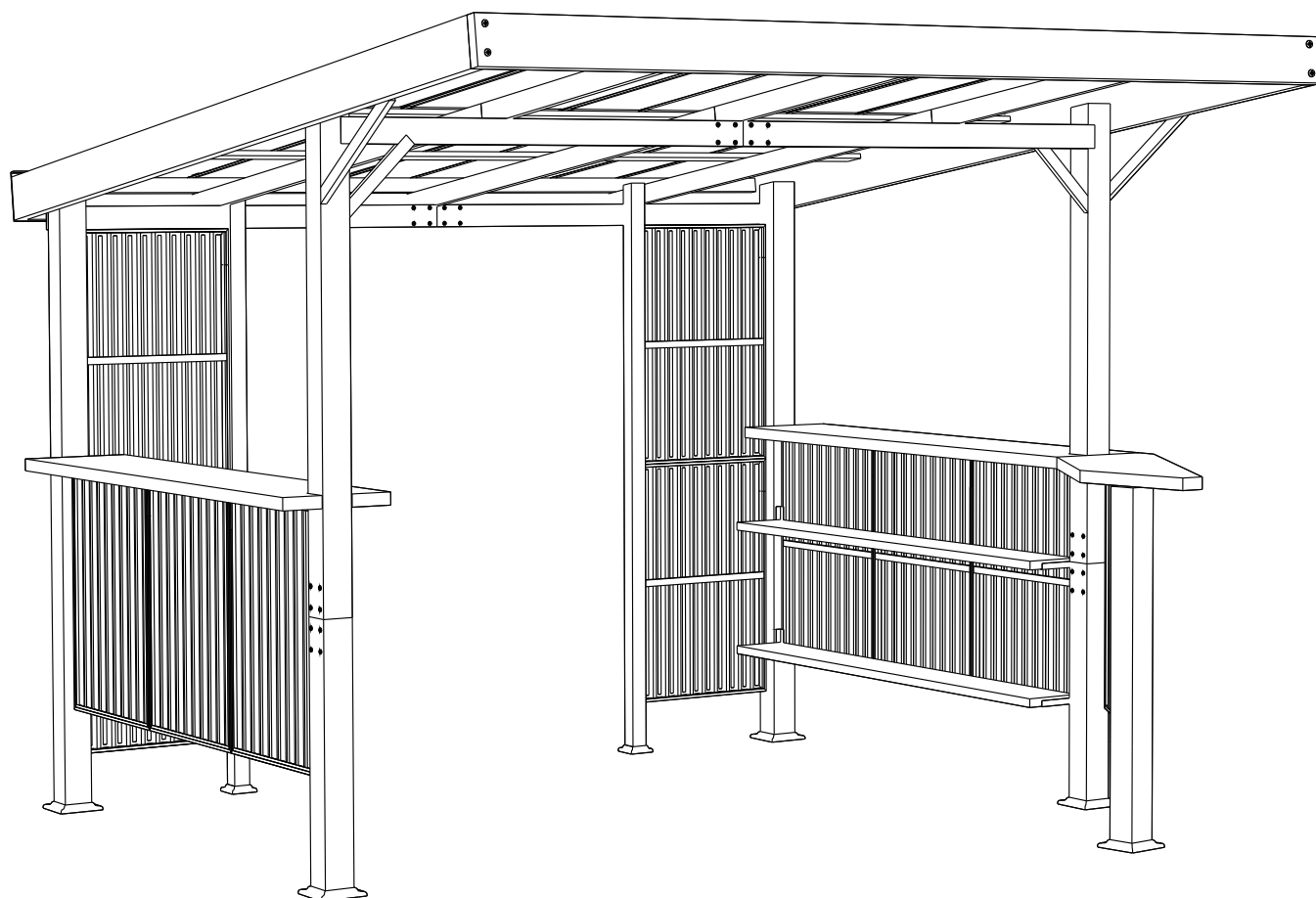

24-P026

IMPORTANT

PLEASE READ BEFORE YOU COMMENCE ASSEMBLY

Follow the guidelines in this user guide to ensure correct assembly and care for this product.

Catalog

Specifications..... 02

Notice And Warning 03

Exploded Views 05

First Part 06

Second Part 07

Third Part 08

Fourth Part..... 09

Fifth Part..... 10

Parts List..... 11

Hardware List..... 14

How to Assemble Hartop Gazbo..... 15

SPECIFICATIONS

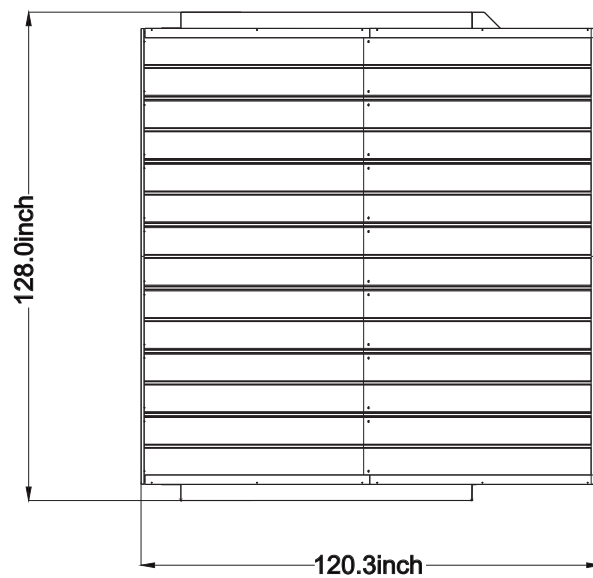
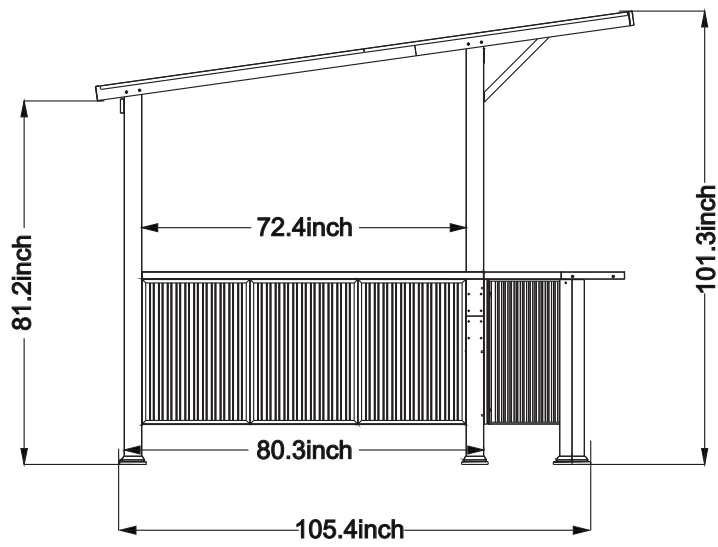
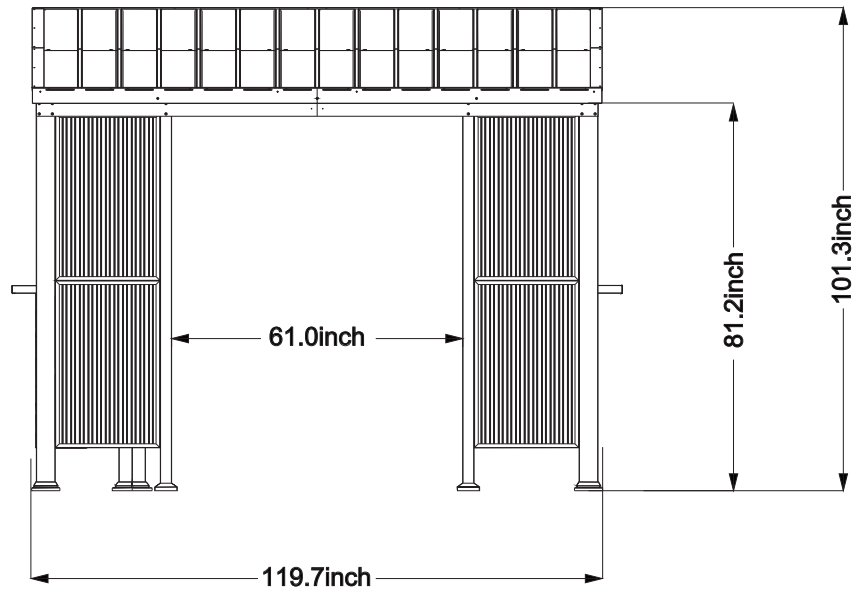

NOTICE 

Note: The gazebo needs to be installed in cooperation with four people. The following tools are not included and needed for assembly:



Pistol Drill



Tape Measure

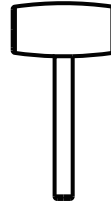

Rubber Hammer

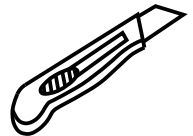

knife



Screw Driver

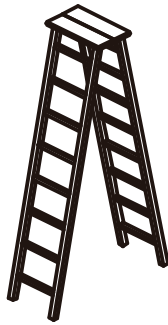

2 m Adjustable Ladder

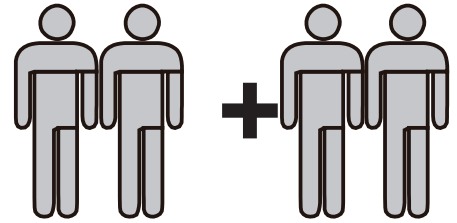

2-4 people

Warning

1. This pavilion requires the cooperation of 2-4 people.
2. Please take appropriate actions as heavy rain, wind and snow can damage the gazebo. If necessary please disassemble and store it for later use.
3. In snowy conditions, please do not allow the thickness of the snow to be more than 1.82 inches on the roof, this should be cleared as soon as possible for your safety.
4. When the wind speed reaches 38.49 km/h, please take measures to avoid the wind.

PLEASE RETAIN THESE INSTRUCTIONS FOR FUTURE REFERENCE.**Dear Customer,****Thank you for shopping from us!**

When you receive the product, please make sure that all the parts are intact. Then please browse the entire installation manual before assembling.

If any problem occurs unsatisfactorily as follows :

- A.The outer box is damaged
- B.The product is damaged / bent / cracked while you open the box
- C.The parts / accessories / assembly tools are missing
- D.The product is hard to assemble
- E. The instructions are not clear and can not be referred
- F.The product has functional problems
- G.Other aspects that you are not satisfied with

Please feel free to contact us for help. Our after-sales team service (**Service@alaulm.com**) will reply within 24 hours and will do our best to resolve the problem for you.

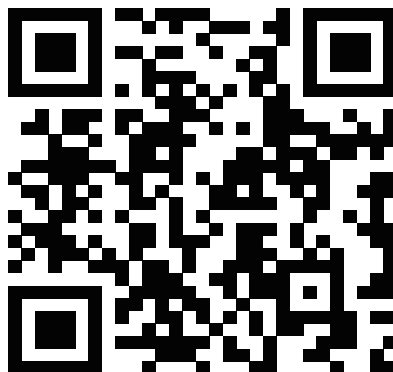
**Attention:**

- 1.Please fix all the screws first,do not lock them off,after assembling is fully completed, lock all at once finally.
- 2.Please check the manual carefully and make sure you have received all the parts.
- 3.If there is any missing,please let us know the letter of the parts you need.
- 4.If there is any damage,please send clear photos to us,and we will check and offer you best solution soon.

EXPLODED VIEWS

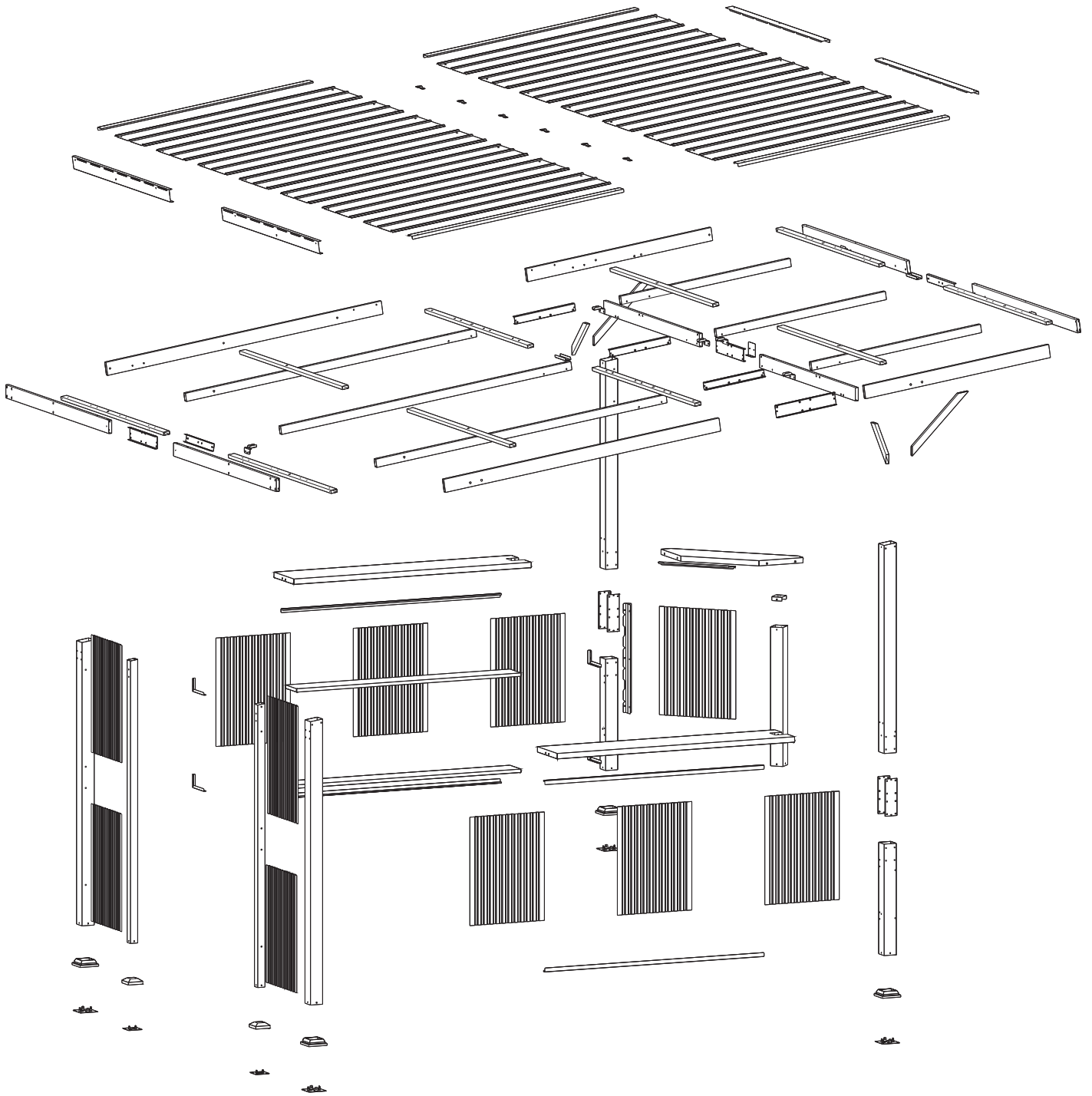

FIRST PART

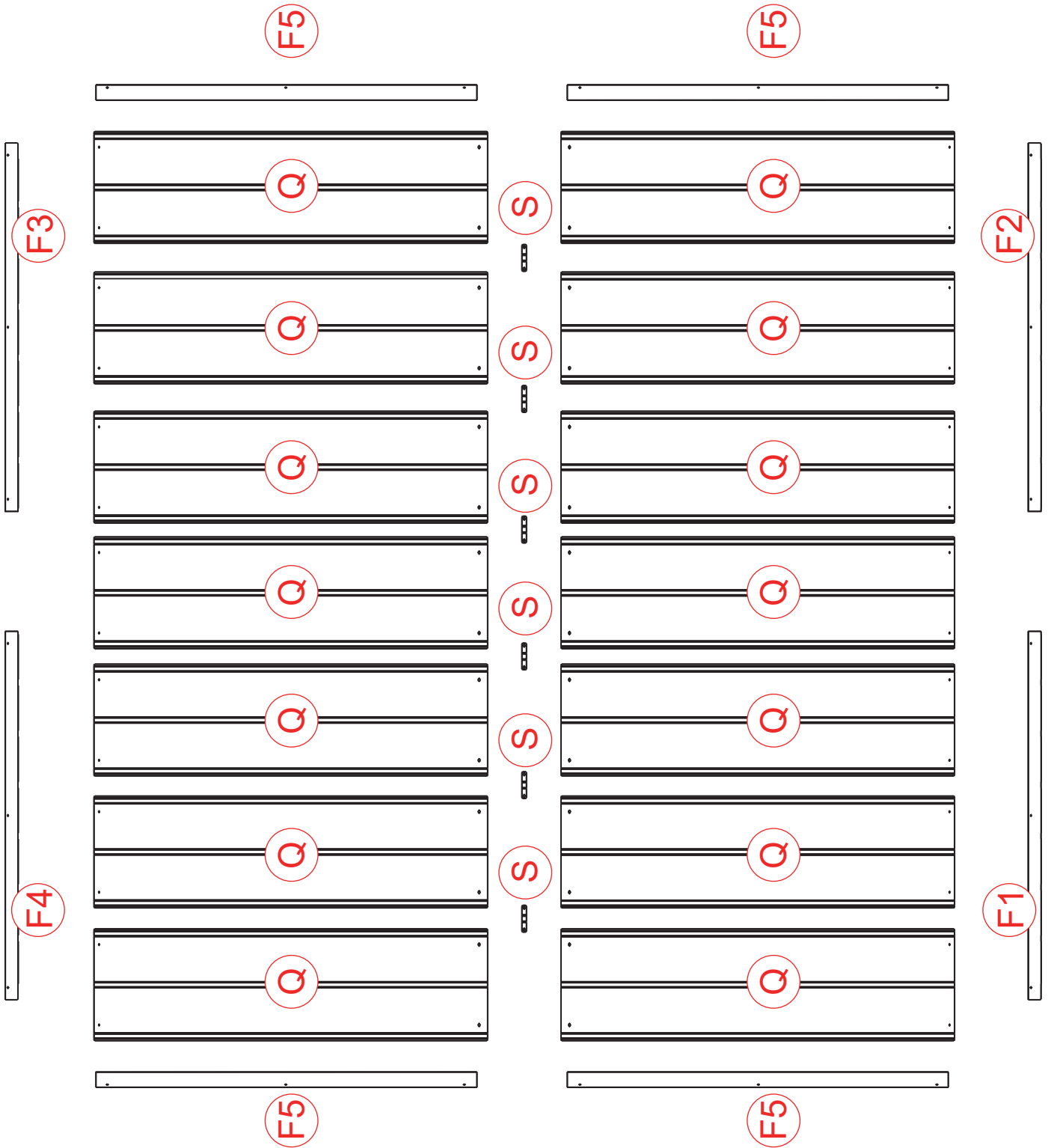

SECOND PART

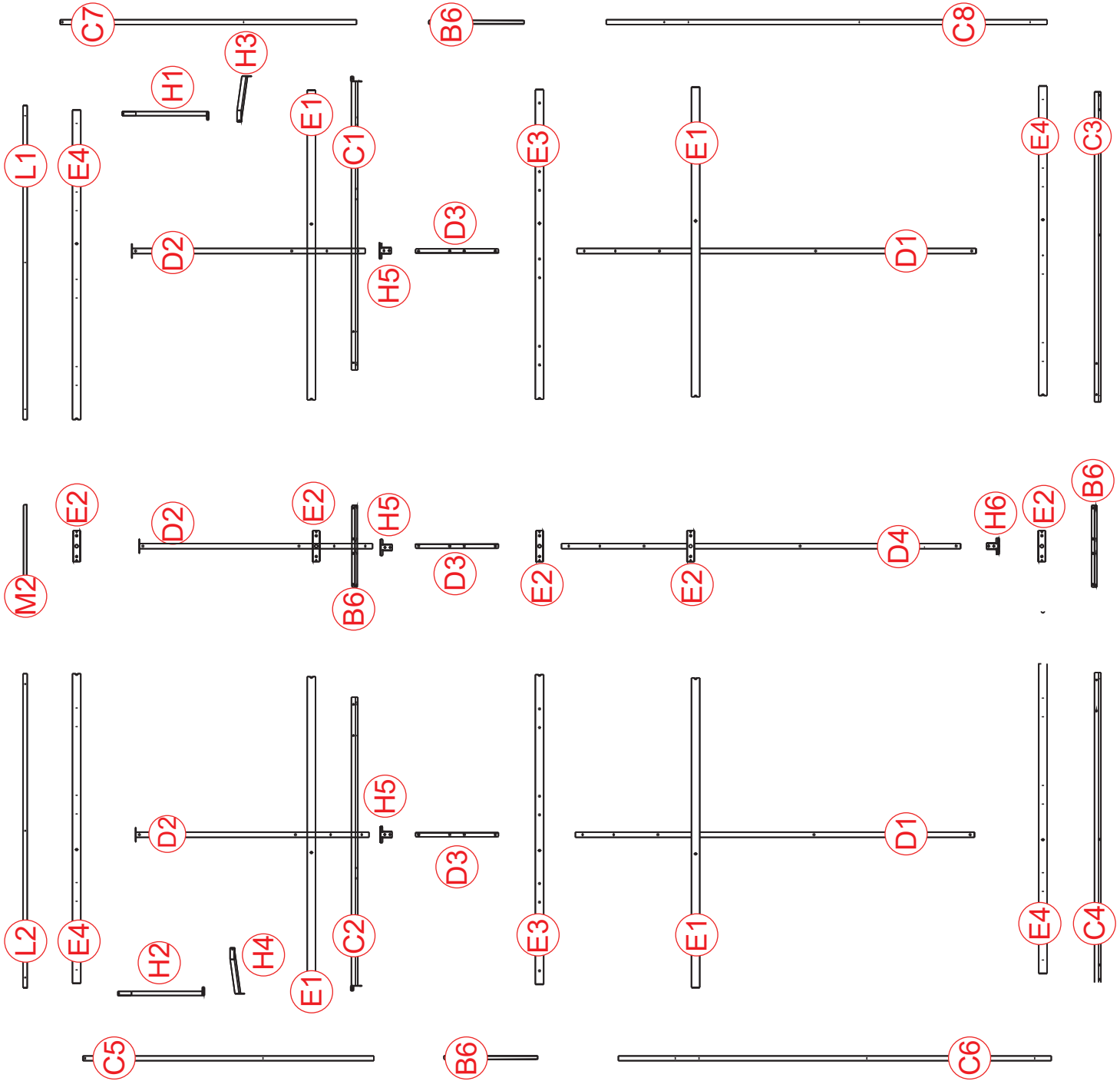

THIRD PART

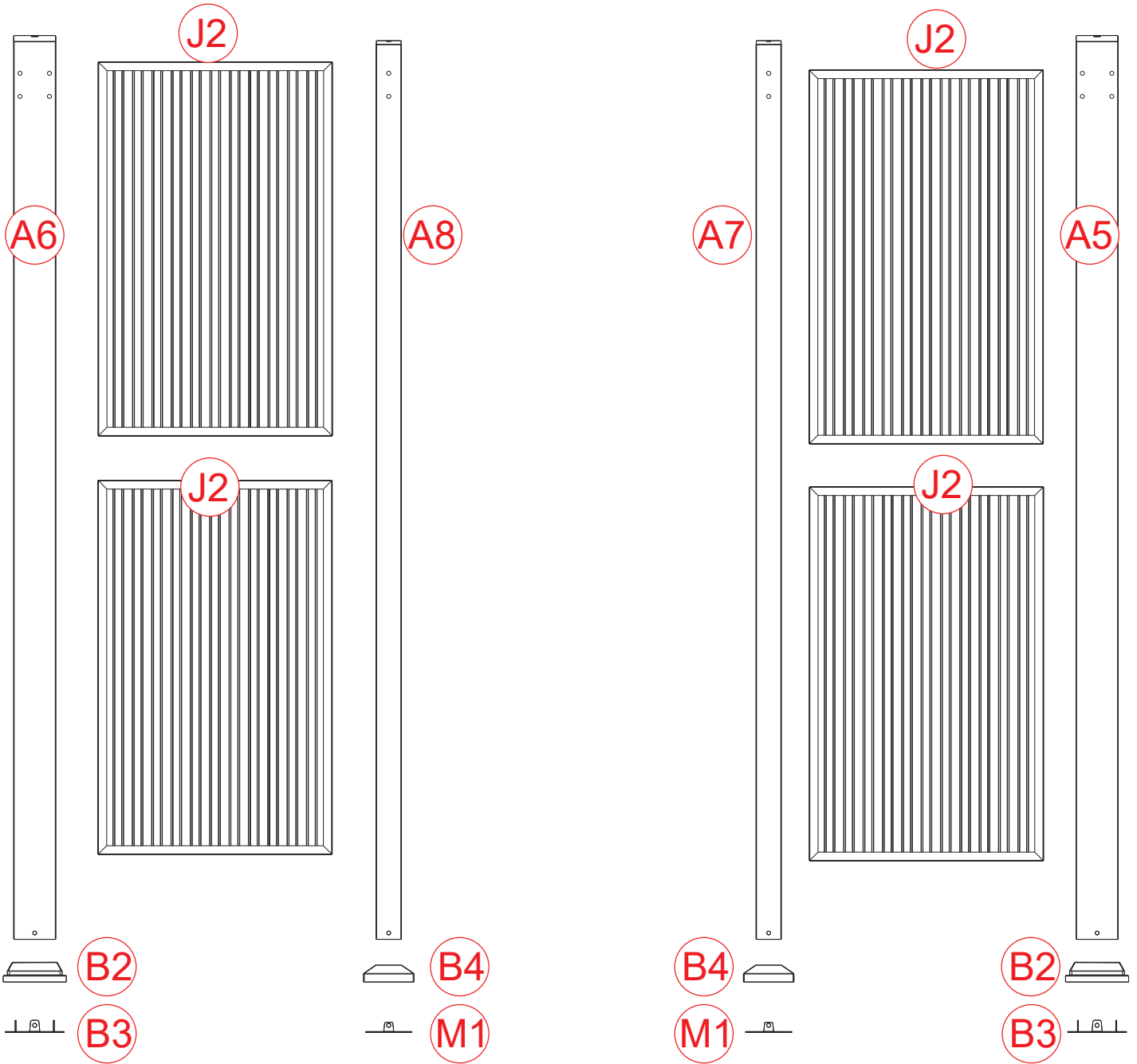

FOURTH PART

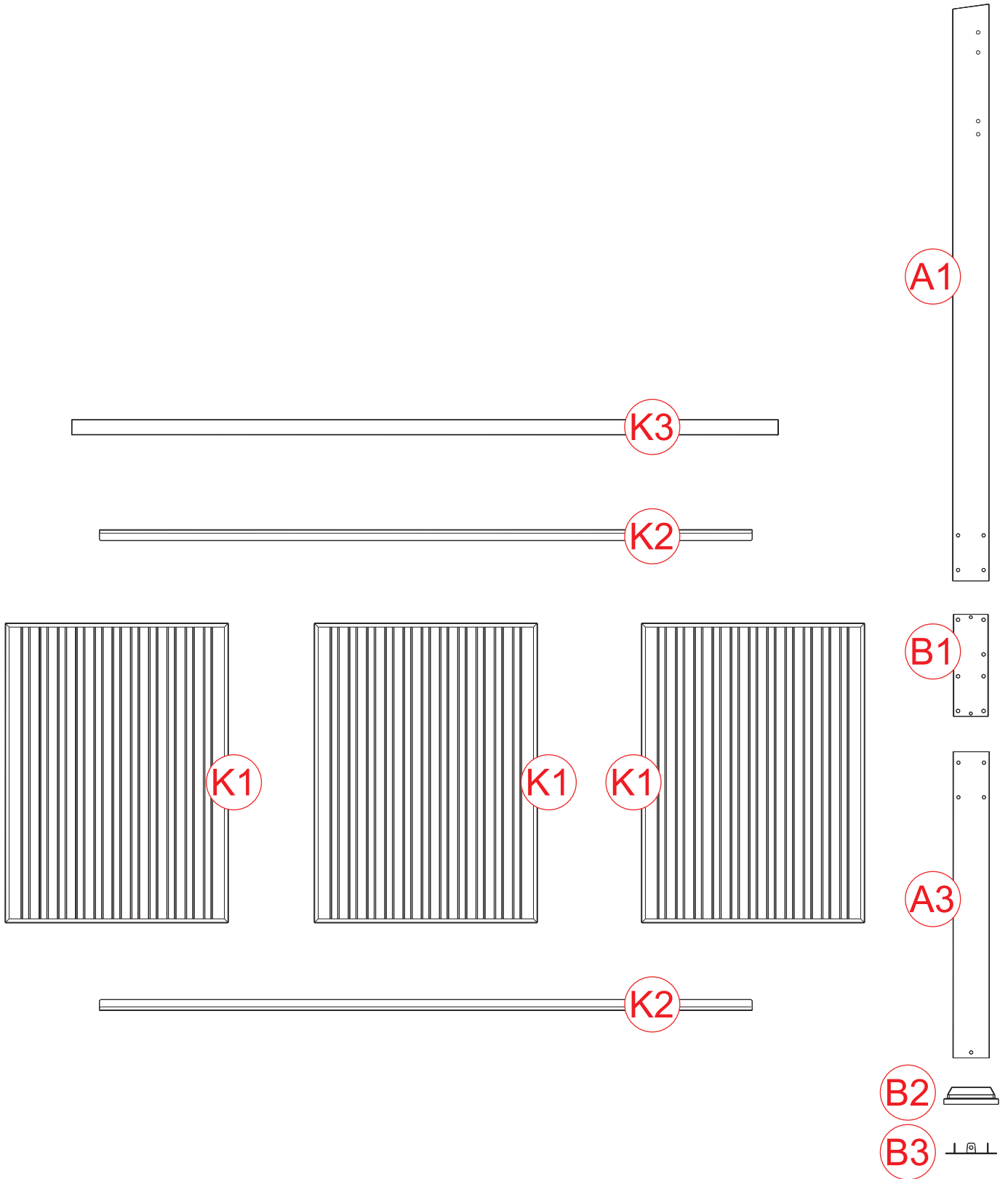



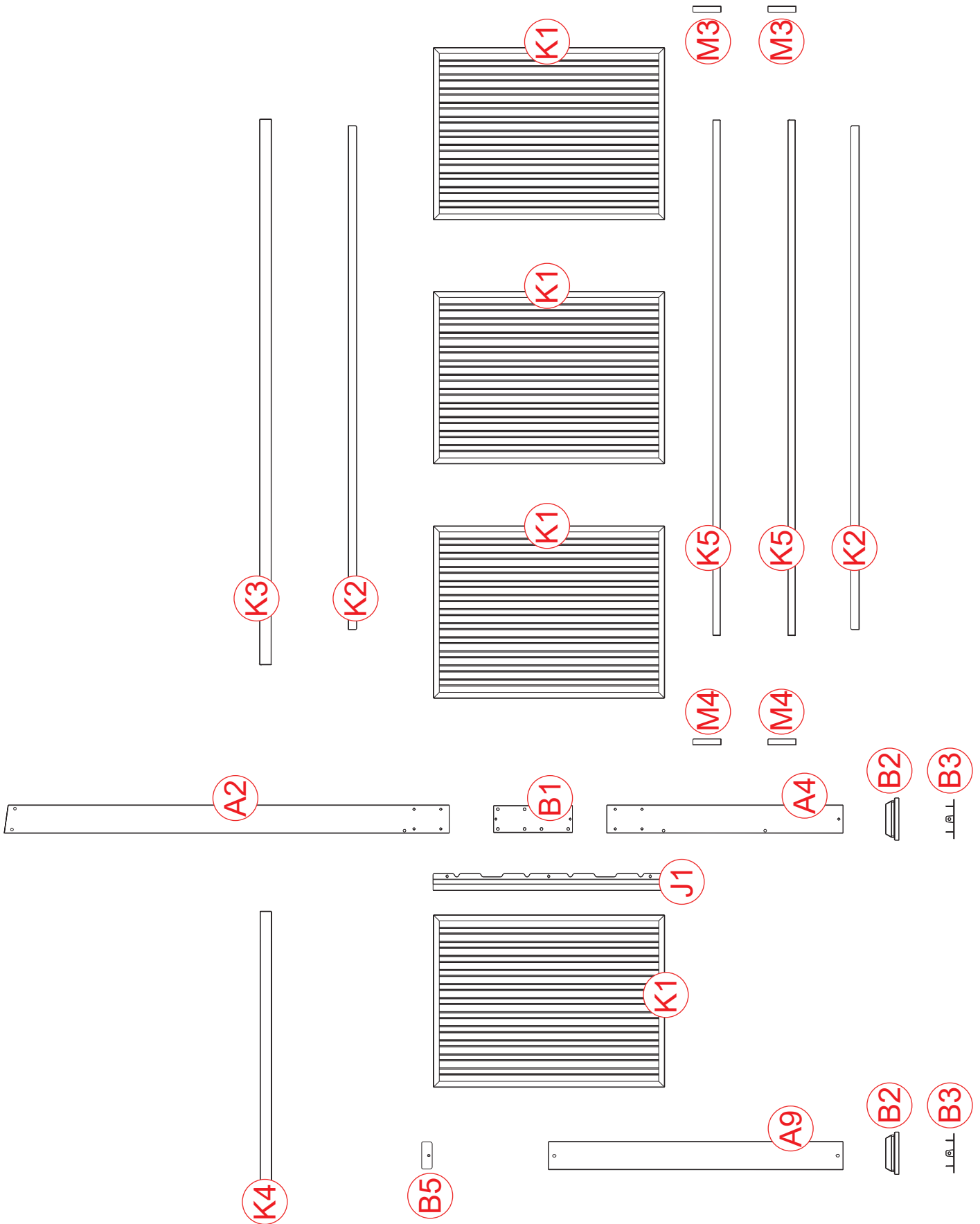

FIFTH PART



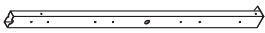
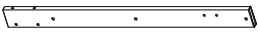
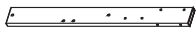
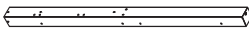
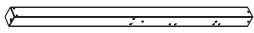

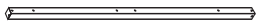

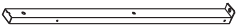





PARTS LIST





Parts List (Box A)

| | | | | |
|--|--|--|---|--|
| E4  | C6  | C8  | A5  | A6  |
| Upper and Lower Roof Beam | Side Long Beam Left | Side Long Beam Right | Column 1 | Column 2 |
| 4 PCS | 1 PC | 1 PC | 1 PC | 1 PC |
| A7  | A8  | K2  | E3  | |
| Small column 1 | Small column 2 | Screen Reinforcement Plate | Intermediate Roof Beam (with holes) | |
| 1 PC | 1 PC | 4 PCS | 2 PCS | |





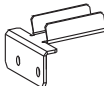





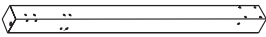
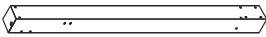
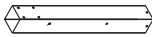
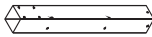

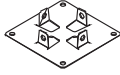
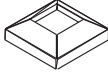
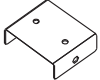

Parts List (Box B)

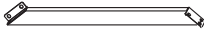
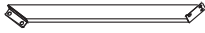
| | | | | |
|--|--|--|---|--|
| D1  | E1  | D4  | F1  | F2  |
| Center Side Long Beam | Intermediate Roof Beam (no holes) | Long Intermediate Beam | Lower Baffle Left | Lower Baffle Right |
| 2 PCS | 4 PCS | 1 PC | 1 PC | 1 PC |
| F3  | F4  | F5  | K5  | K3  |
| Upper Pressure Bar Right | Upper Pressure Bar Left | Side Baffle | Partition | Countertop |
| 1 PC | 1 PC | 4 PCS | 2 PCS | 2 PCS |

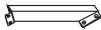
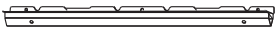
Parts List (Box C)

| | | | | |
|--|--|--|--|--|
| E2  | D3  | H5  | H6  | M2  |
| Top Beam Insert | Intermediate Beam Insert | Intermediate Beam Connector on | Under Intermediate Beam Connector | Front Crossmember Insert |
| 5 PCS | 3 PCS | 3 PCS | 1 PC | 1 PC |

PARTS LIST







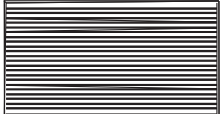

| | | | | |
|---|---|---|--|--|
| <p>(A1)</p>  <p>Column KD Upper 1</p> <p>1 PC</p> | <p>(A2)</p>  <p>Column KD Upper 2</p> <p>1 PC</p> | <p>(A3)</p>  <p>Column KD Lower 1</p> <p>1 PC</p> | <p>(A4)</p>  <p>Column KD Lower 2</p> <p>1 PC</p> | <p>(A9)</p>  <p>Short Column</p> <p>1 PC</p> |
| <p>(B1)</p>  <p>Column Insert</p> <p>4 PCS</p> | <p>(B2)</p>  <p>Large Spike Cover</p> <p>5 PCS</p> | <p>(B3)</p>  <p>Large Ground Spike</p> <p>5 PCS</p> | <p>(B4)</p>  <p>Small Spike Cover</p> <p>2 PCS</p> | <p>(B5)</p>  <p>Small Countertop Connection Tab</p> <p>1 PC</p> |
| <p>(B6)</p>  <p>Crossbeam Insert</p> <p>4 PCS</p> | <p>(B7)</p>  <p>Center Ferrule</p> <p>2 PCS</p> | <p>(H1)</p>  <p>Long Diagonal Brace 1</p> <p>1 PC</p> | <p>(H2)</p>  <p>Long Diagonal Brace 2</p> <p>1 PC</p> | <p>(H3)</p>  <p>Short Diagonal Brace 1</p> <p>1 PC</p> |
| <p>(H4)</p>  <p>Short Diagonal Brace 2</p> <p>1 PC</p> | <p>(J1)</p>  <p>Beveled Edge Reinforcement</p> <p>1 PC</p> | <p>(K4)</p>  <p>Small Countertop</p> <p>1 PC</p> | <p>(M1)</p>  <p>Small Ground Spike</p> <p>2 PCS</p> | <p>(M3)</p>  <p>Bulkhead Connector 1</p> <p>2 PCS</p> |
| <p>(M4)</p>  <p>Bulkhead Connector 2</p> <p>2 PCS</p> | <p>(S)</p>  <p>Layer</p> <p>8 PCS</p> | | | |

PARTS LIST

Parts List (Box D)



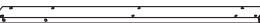
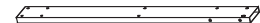







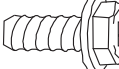

| | | | | |
|---|---|--|--|--|
| (K1) | (J2) | | | |
|  |  | | | |
| Short Screen | Long Screen | | | |
| 7 PCS | 4 PCS | | | |

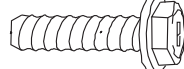
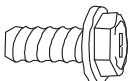
Parts List (Box E)

| | | | | |
|---|---|---|--|---|
| (D2) | (C1) | (C2) | (C5) | (C7) |
|  |  |  |  |  |
| Short Intermediate Beam | Middle Beam Right | Middle Beam Left | Side Short Crossbar Left | Side Short Crossbar Right |
| 3 PCS | 1 PC | 1 PC | 1 PC | 1 PC |
| (L1) | (L2) | (C3) | (C4) | (Q) |
|  |  |  |  |  |
| Front Cross Member Right | Front Cross Member Left | Rear Crossbar Left | Rear Crossbar Right | Roof |
| 1 PC | 1 PC | 1 PC | 1 PC | 14 PCS |

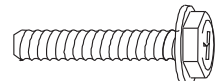
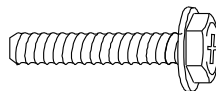
HARDWARE LIST

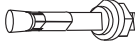
Hardware List (Box E)

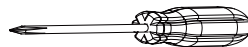
| | | | | |
|--|--|---|--|--|
| <p>AA</p>  <p>M4 × 16</p> <p>59 PCS</p> | <p>BB</p>  <p>26 PCS</p> | <p>CC</p>  <p>M6 × 20</p> <p>16 PCS</p> | <p>DD</p>  <p>M6</p> <p>9 PCS</p> | <p>FF</p>  <p>M6 × 25</p> <p>33 PCS</p> |
| <p>GG</p>  <p>M6 × 15</p> <p>263 PCS</p> | <p>KK</p>  <p>M6 × 35</p> <p>43 PCS</p> | <p>LL</p>  <p>M6</p> <p>9 PCS</p> | <p>MM</p>  <p>M6</p> <p>16 PCS</p> | <p>QQ</p>  <p>M6 × 30</p> <p>18 PCS</p> |
| <p>RR</p>  <p>M6 × 45</p> <p>3 PCS</p> | <p>PP</p>  <p>D8 × 180</p> <p>8 PCS</p> | <p>UU</p>  <p>M6 × 80</p> <p>8 PCS</p> | <p>Z1</p>  <p>Wrench M6</p> <p>2 PCS</p> | <p>Z2</p>  <p>Spanner M6</p> <p>2 PCS</p> |
| <p>Z3</p>  <p>Phillips screwdriver</p> <p>2 PCS</p> | | | | |

1. Please ensure that all accessories are complete before starting the installation.

2. Due to the variety of accessories, many accessories may be glued together, please check carefully

3. If any accessories are missing or damaged, please contact the seller immediately.

E-Mail: Service@alaulm.com

INSTRUCTION

STEP 1

As shown in the figure below, first align the holes of the Large Ground Spike (B3) with the Column KD Lower 1 (A3) and tighten them with M6×15(GG) bolts, then put the Large Spike Cover (B2) on A3. Then connect the columns A1 and A3 by two Column Inserts (B1), first insert one end of the connectors into one column and tighten it, then set it into another column, then align the holes and tighten it with M6×15(GG) bolts.
Note: A1 above is high in the front and low in the back.

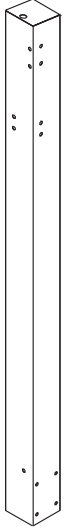

A1 1x

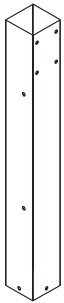

A3 1x

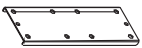

B1 2x



B2 1x



B3 1x

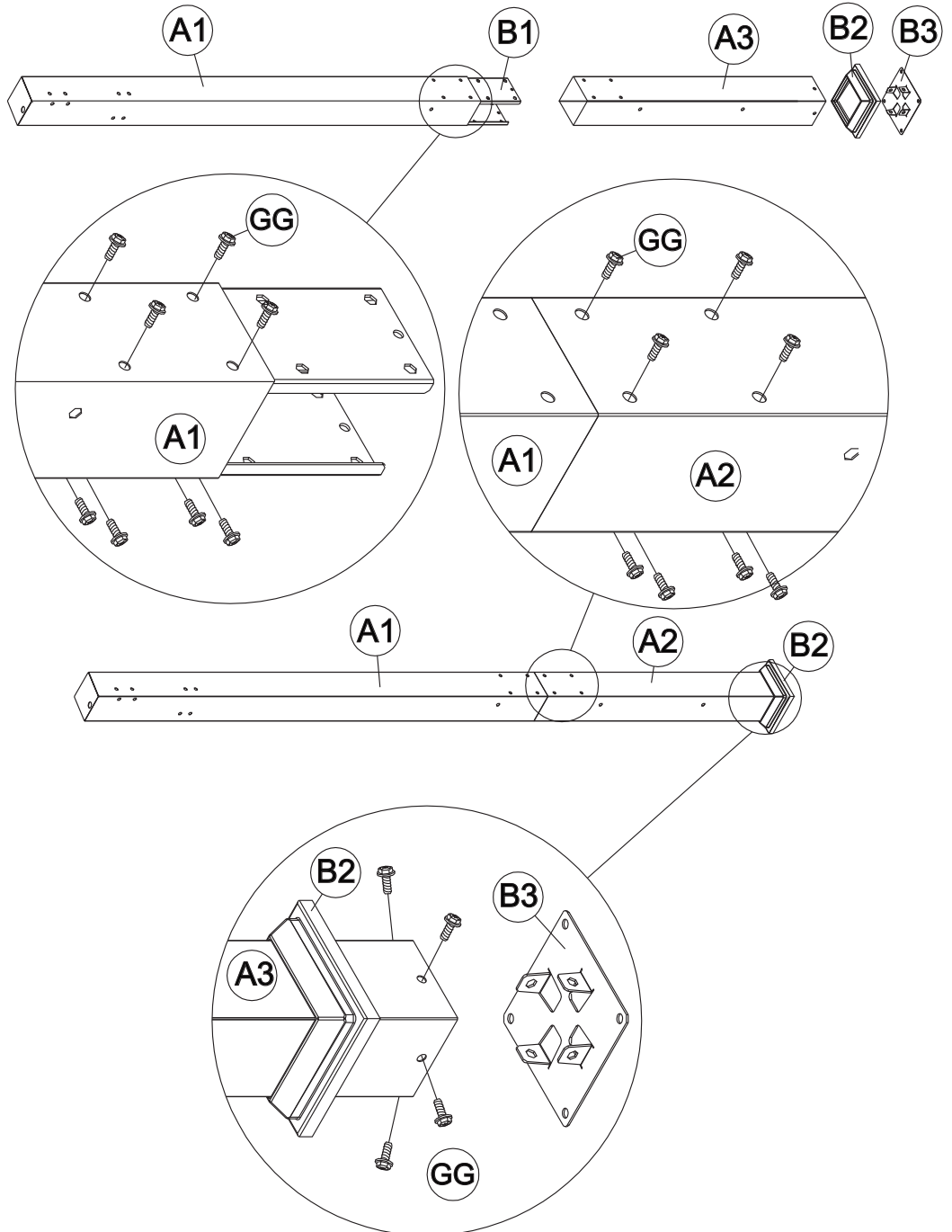

GG 20x

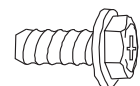

M6x15

INSTRUCTION

STEP 2

As shown in the figure below, first align the holes of the Large Ground Spike (B3) with the Column KD Lower 2 (A4) and tighten them with M6×15(GG) bolts, then put the Large Spike Cover (B2) on A4. Then connect the columns A2 and A4 by two Column Inserts (B1), first insert one end of the connectors into one column and tighten it, then set it into another column, then align the holes and tighten it with M6×15(GG) bolts.
Note: A2 above is high in the front and low in the back.

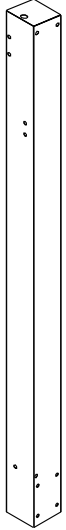

(A2) 1x

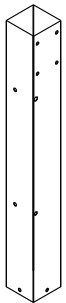

(A4) 1x

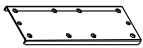

(B1) 2x

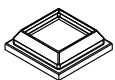

(B2) 1x



(B3) 1x

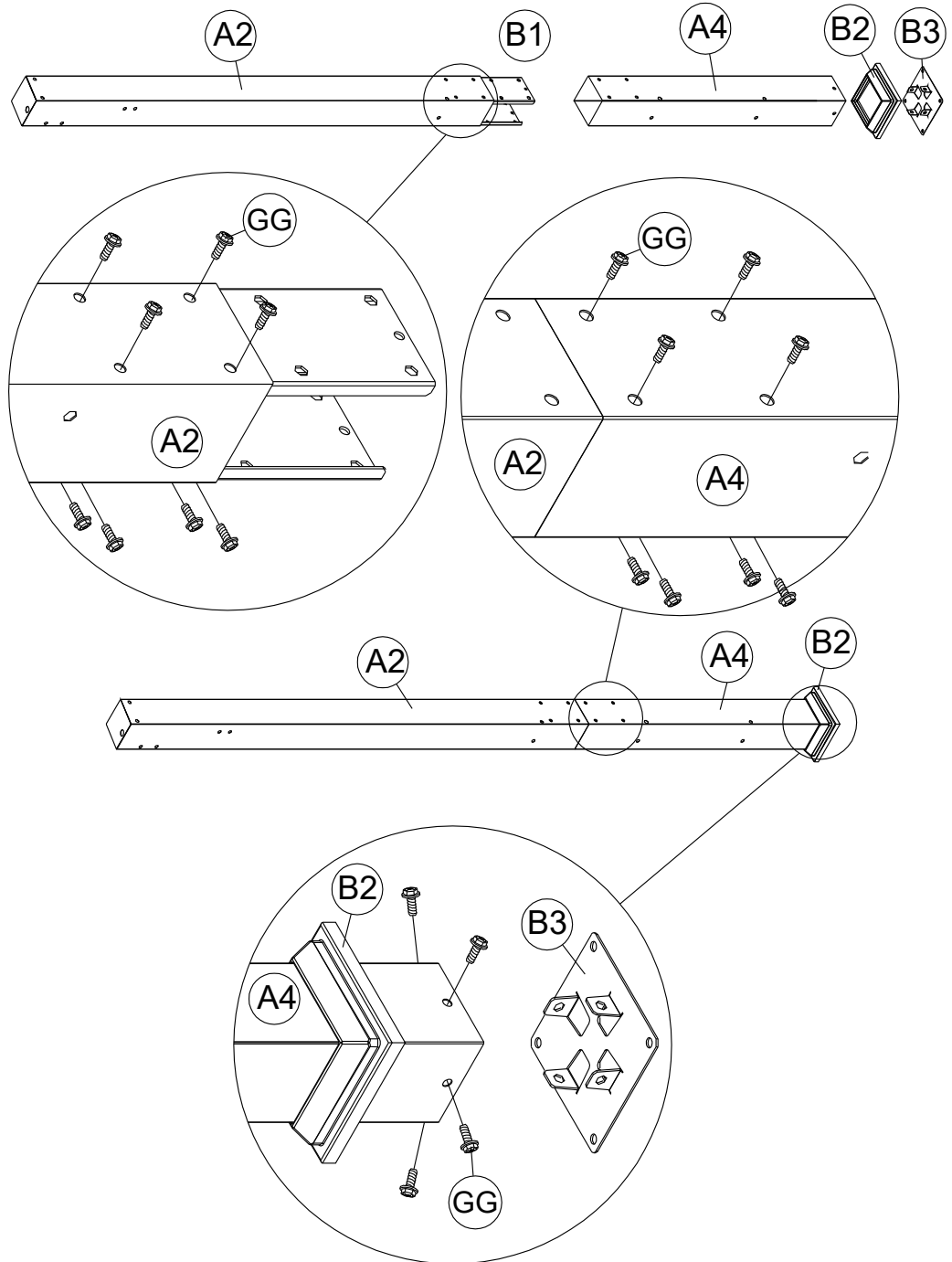

(GG) 20x

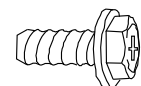

M6x15

STEP 3

Sleeve the Large Spike Cover (B2) onto the Column 1 (A5) first, then align the Large Ground Spike (B3) with the hole at the bottom of the Column 1 (A5), and tighten it using the bolt M6×15 (GG).

Note: The top of the Column 1 (A5) has a beveled opening.

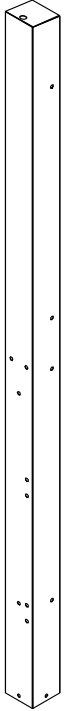

A5 1x



B2 1x



B3 1x

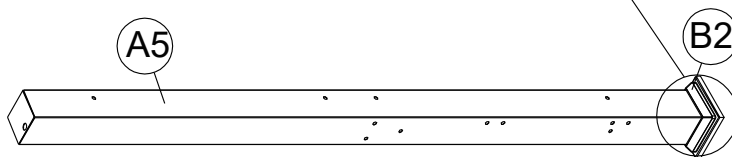
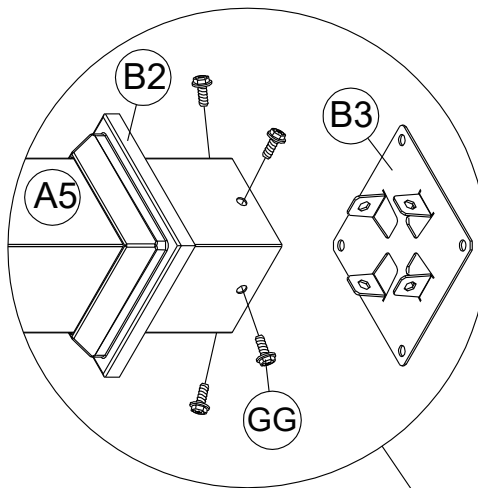
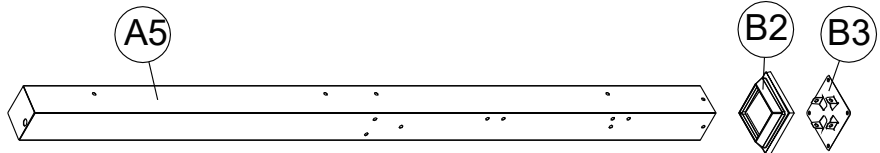

GG 4x

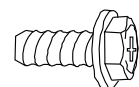

M6x15

STEP 4

Sleeve the Large Spike Cover (B2) onto the Column 2 (A6) first, then align the Large Ground Spike (B3) with the hole at the bottom of the Column 2 (A6), and tighten it using the bolt M6×15 (GG).

Note: The top of the Column 2 (A6) has a beveled opening.



A6 1x



B2 1x



B3 1x

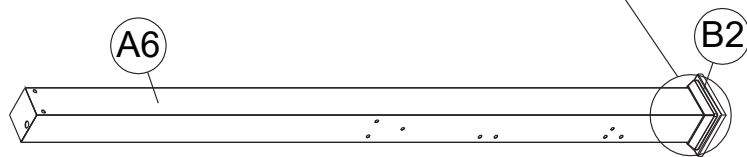
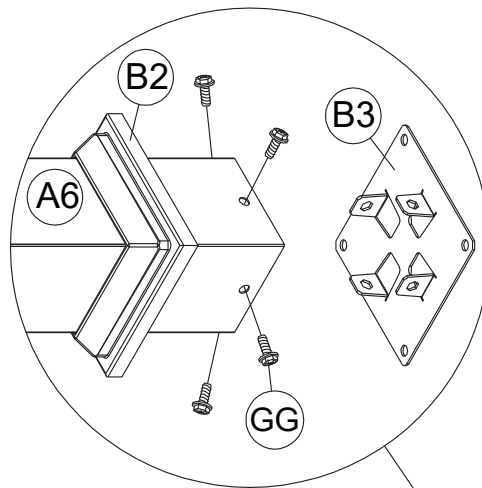
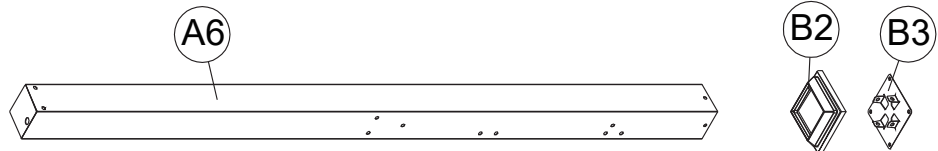

GG 4x

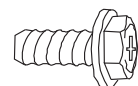

M6x15

STEP 5

Sleeve the Small Spike Cover (B4) onto the Small Column 1 (A7) first, then align the Small Ground Spike (M1) with the hole at the bottom of the Small Column 1 (A7), and tighten it using the bolt M6×15 (GG).

Note: The top of the Small Column 1 (A7) has a beveled opening.

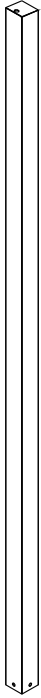

(A7) 1x

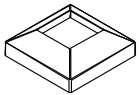

(B4) 1x

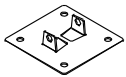

(M1) 1x

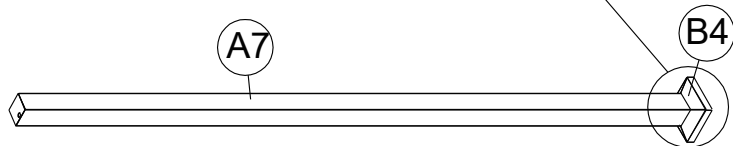
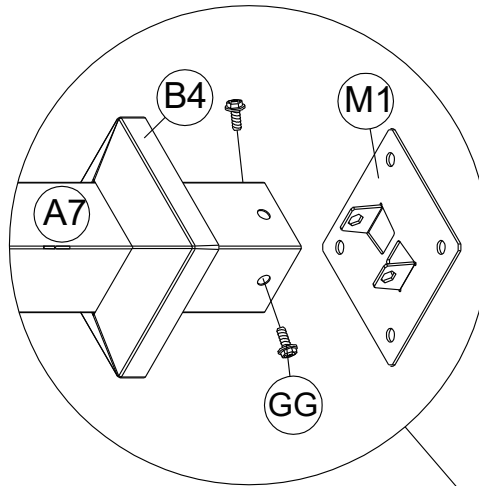
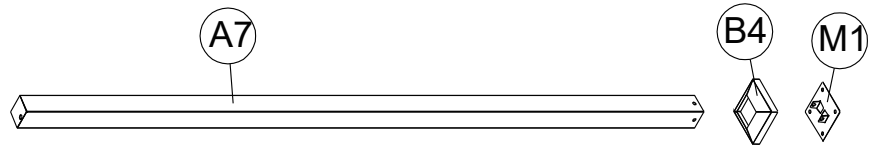

(GG) 2x

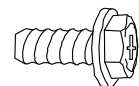

M6x15

STEP 6

Sleeve the Small Spike Cover (B4) onto the Small Column 2 (A8) first, then align the Small Ground Spike (M1) with the hole at the bottom of the Small Column 2 (A8), and tighten it using the bolt M6×15 (GG).

Note: The top of the Small Column 2 (A8) has a beveled opening.



(A8) 1x

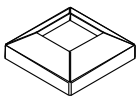

(B4) 1x

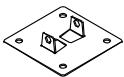

(M1) 1x

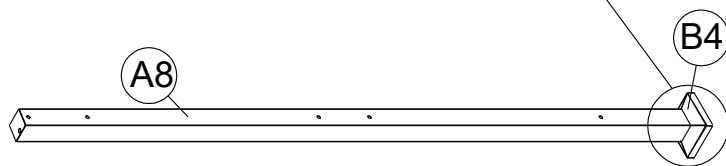
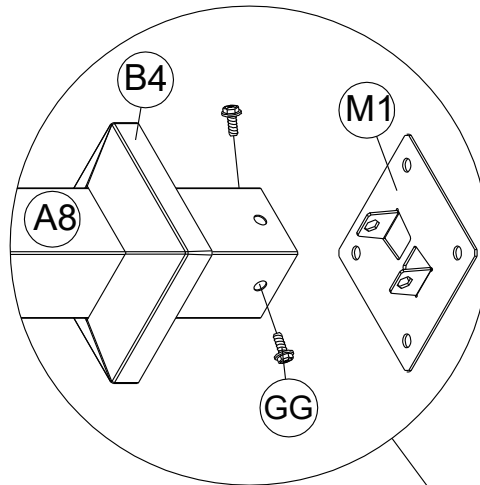
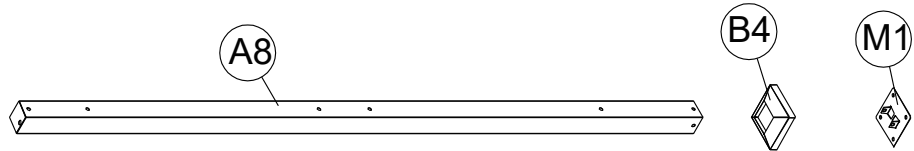

(GG) 2x

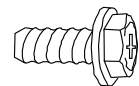

M6x15

STEP 7

Sleeve the Large Spike Cover (B2) onto the Short Column (A9) first, then align the Large Ground Spike (B3) with the hole at the bottom of the Short Column (A9), and tighten it using the bolts M6×15 (GG).

Note: The top of the Short Column (A9) has a beveled opening.

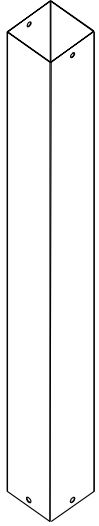

(A9) 1x

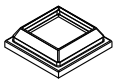

(B2) 1x

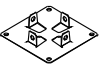

(B3) 1x

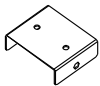

(B5) 1x

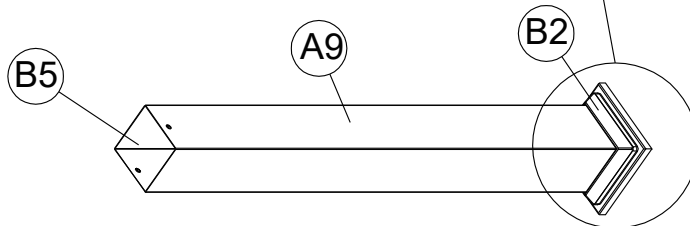
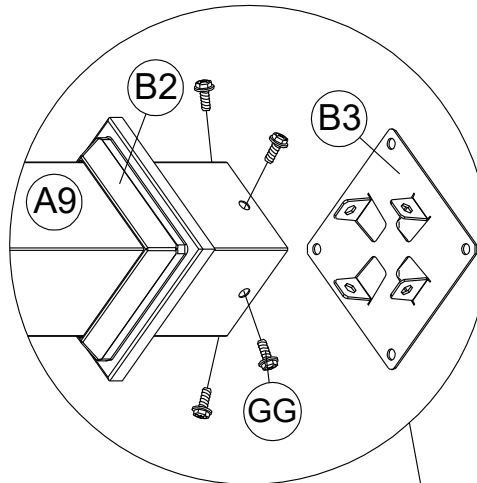
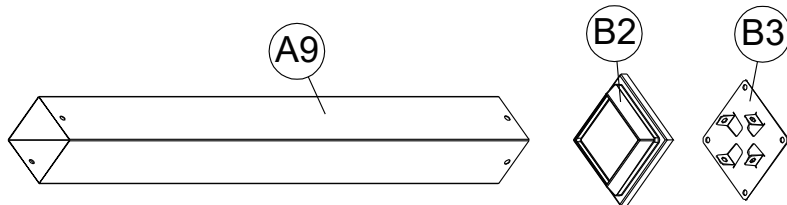

(GG) 4x

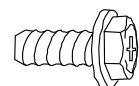

M6x15

STEP 8

Combine one end of the Middle Beam Left (C2) with the Crossbeam Insert (B6) and tighten as shown, using bolts M6 x 15 (GG) in the marked positions. Combine the other end with the Middle Beam Right (C1) as shown and tighten using bolts M6 x 15 (GG) in the marked positions. Finally use the Center Ferrule (B7) to fit between C1 and C2 as shown and tighten using screws M4 x 16 (AA).



C2 1x

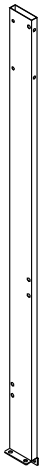

C1 1x

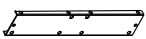

B6 1x



B7 1x

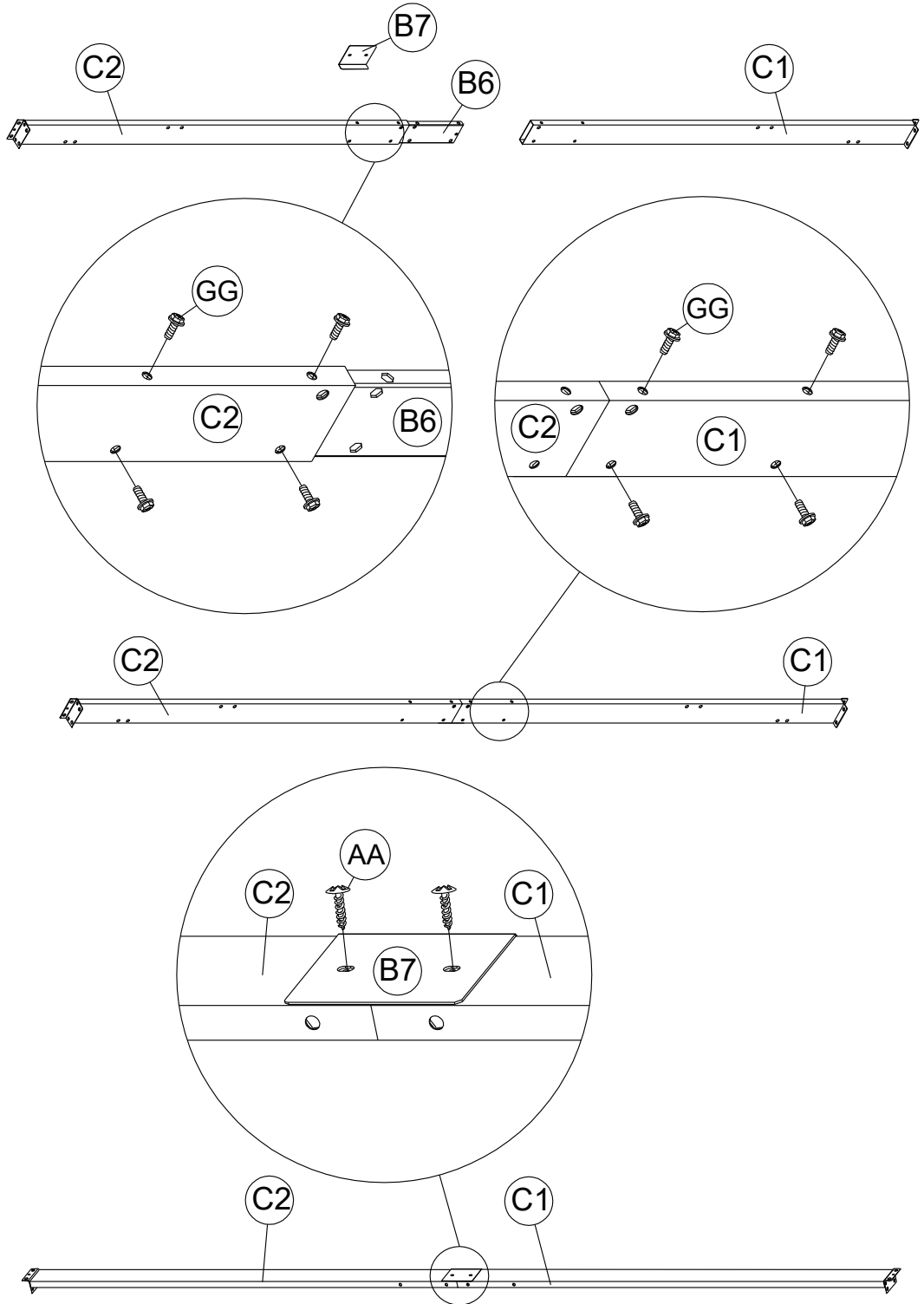

AA 2x



M4x16

GG 8x

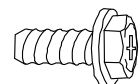

M6x15

STEP 9

Combine one end of the Rear Crossbar Right (C4) with the Crossbeam Insert (B6) and tighten as shown, using bolts M6 x 15 (GG) in the marked positions. Combine the other end with the Rear Crossbar Left (C3) and tighten as shown, using bolts M6 x 15 (GG) in the marked positions. Finally use the center ferrule (B7) to fit in the middle of C1 and C2 as shown and tighten using screws M4 x 16 (AA).



C4 1x



C3 1x

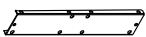

B6 1x



B7 1x

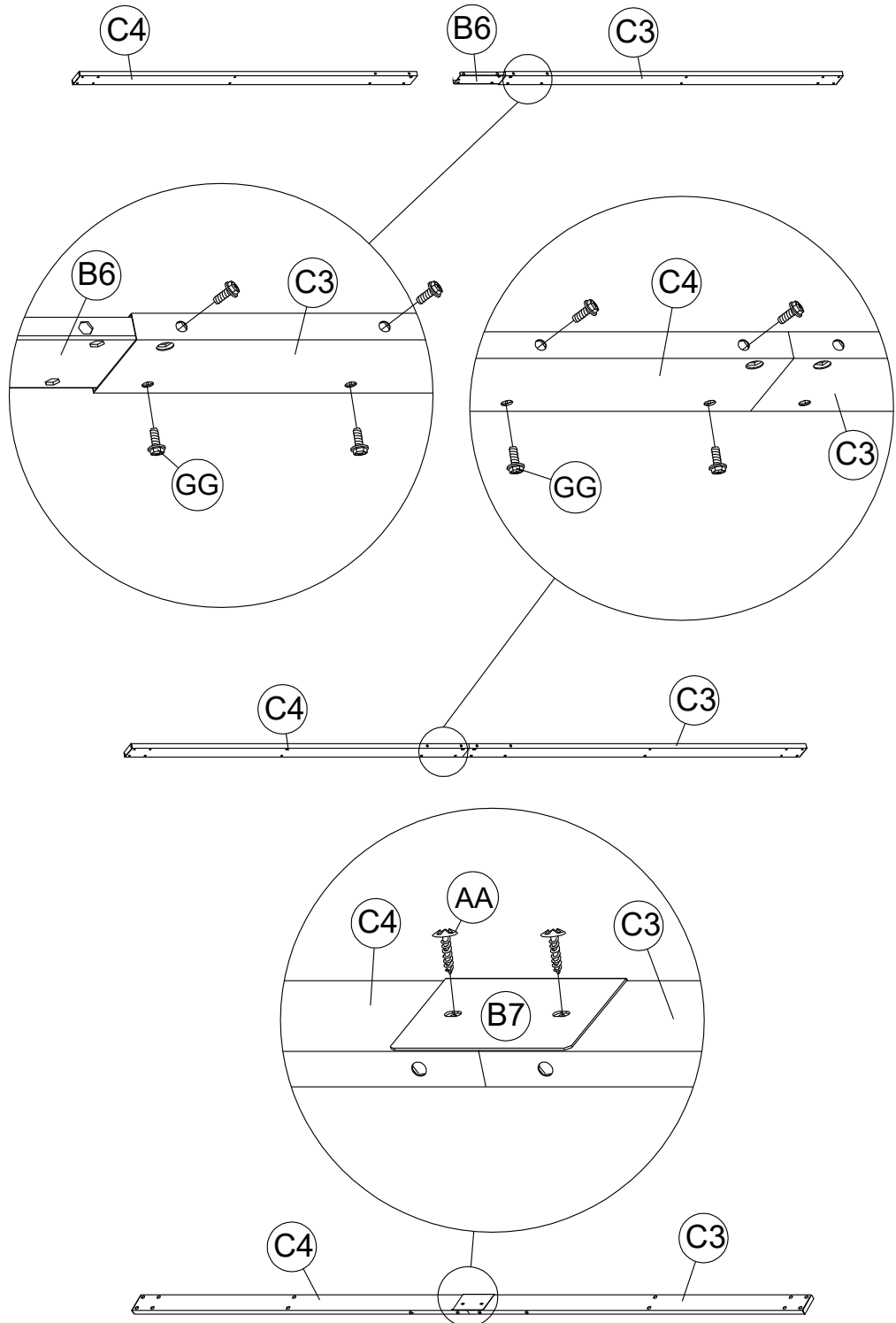

AA 2x



M4x16

GG 8x

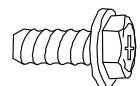

M6x15

STEP 10

Combine one end of the Side Long Beam Left (C6) with the Crossbeam Insert (B6) and tighten with M6 x 15 bolts (GG) at the marked positions as shown. Attach the other end of the Side Short Crossbar Left (C5) to the Crossbeam Insert (B6) and tighten with M6 x 15 bolts (GG) at the marked positions as shown in the figure.



C6 1x



C5 1x

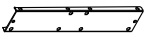

B6 1x

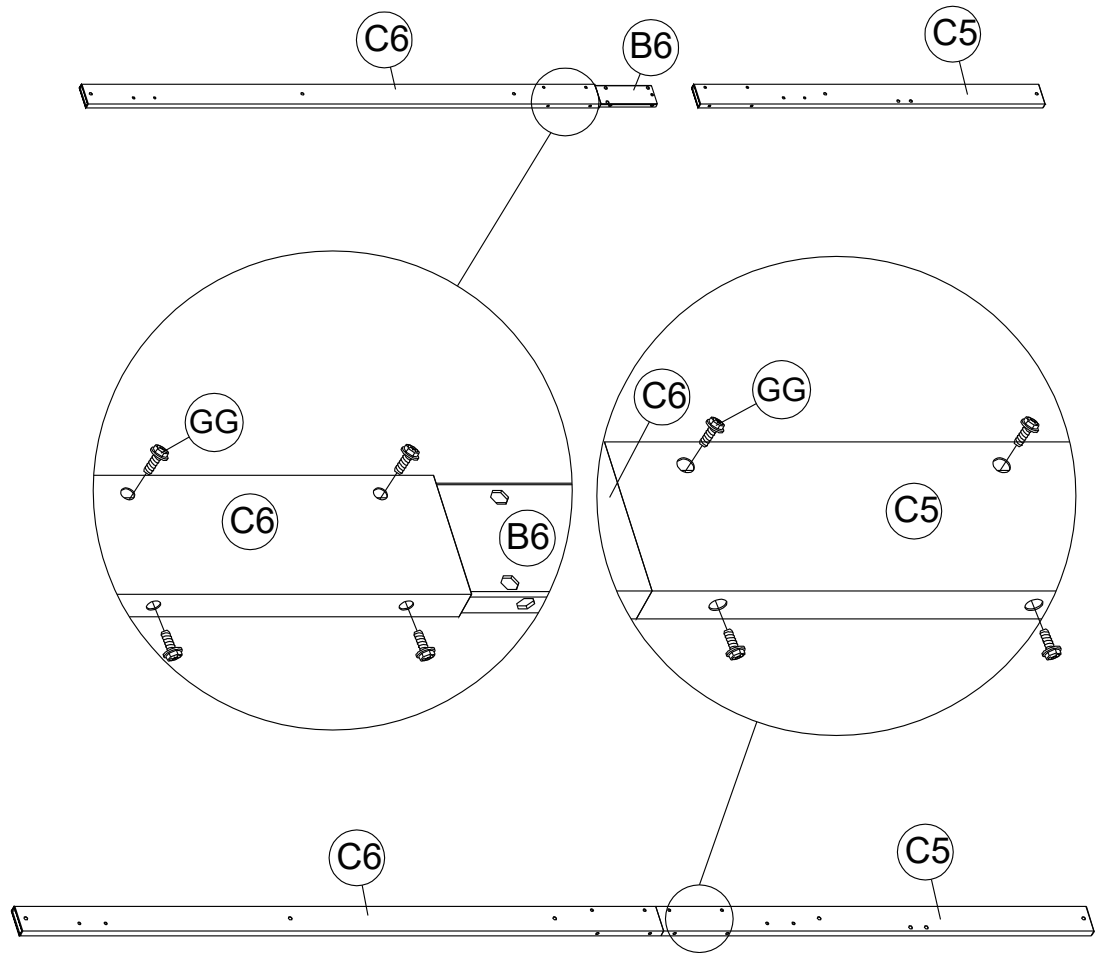

GG 8x

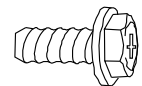

M6x15

STEP 11

Combine one end of the Side Short Crossbar Right (C7) with the Crossbeam Insert (B6) and tighten with M6 x 15 bolts (GG) at the marked positions as shown. Attach the other end of the Side Long Beam Right (C8) to the Crossbeam Insert (B6) and tighten with M6 x 15 bolts (GG) at the marked positions as shown in the figure.



C8 1x



C7 1x

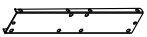

B6 1x

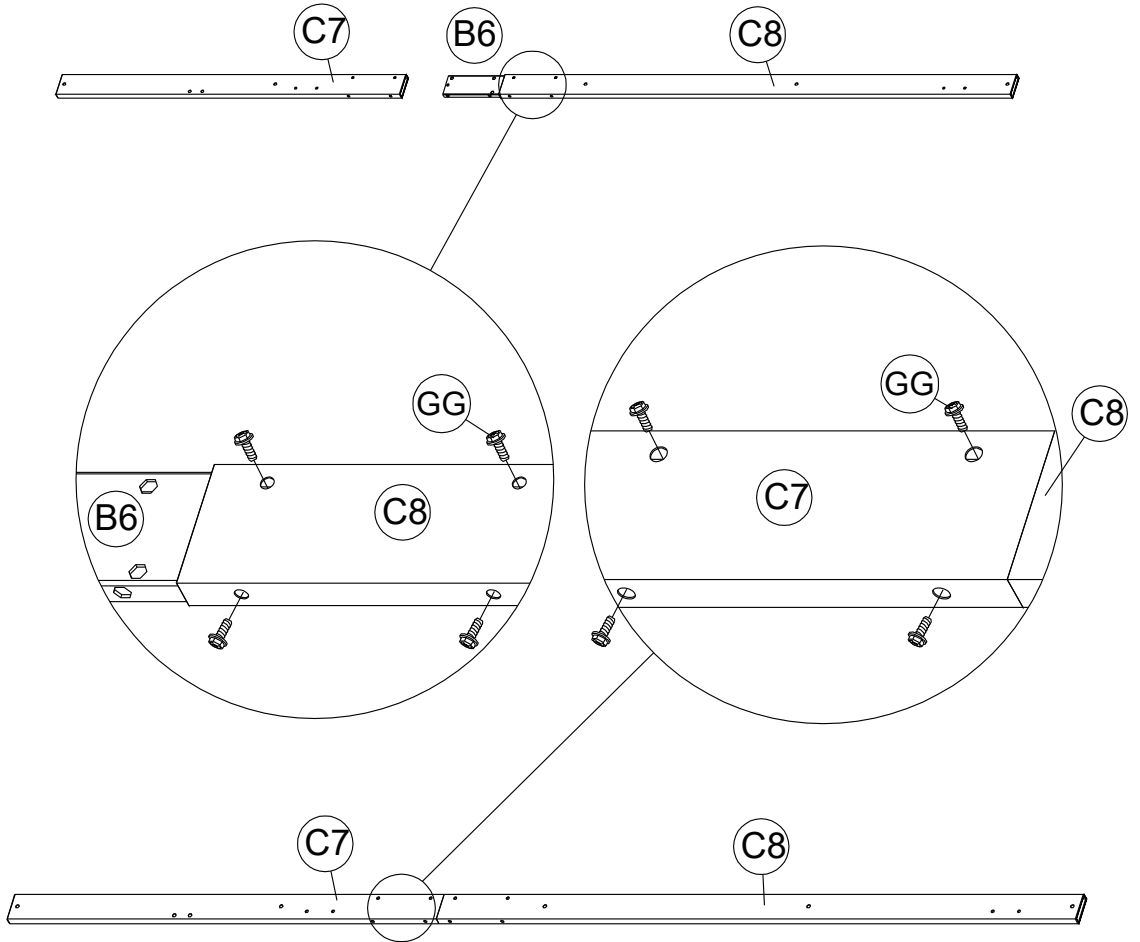

GG 8x

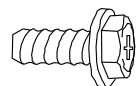

M6x15

STEP 12

Combine one end of the Center Side Long Beam (D1) with the Intermediate Beam Insert (D3) and tighten with M6 x 15 bolts (GG) at the marked positions as shown. Attach the other end of the Short Intermediate Beam (D2) to the Intermediate Beam Insert (D3) and tighten with M6 x 15 bolts (GG) at the marked positions as shown in the figure.



D2 2x



D3 2x



D1 2x

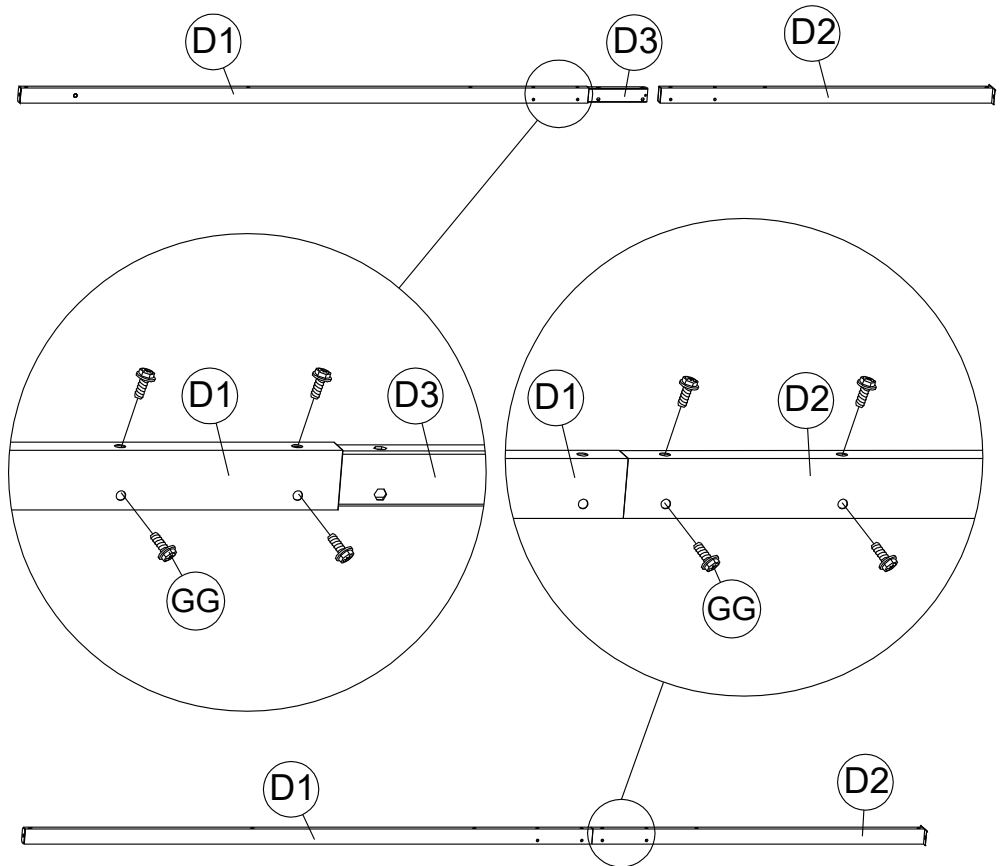

GG 16x

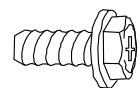

M6x15

STEP 13

Combine one end of the Long Intermediate Beam (D4) with the Intermediate Beam Insert (D3) and tighten with M6 x 15 bolts (GG) at the marked positions as shown. Attach the other end of the Short Intermediate Beam (D2) to the Intermediate Beam Insert (D3) and tighten with M6 x 15 bolts (GG) at the marked positions as shown in the figure.



D2 1x

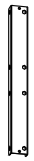

D3 1x



D4 1x

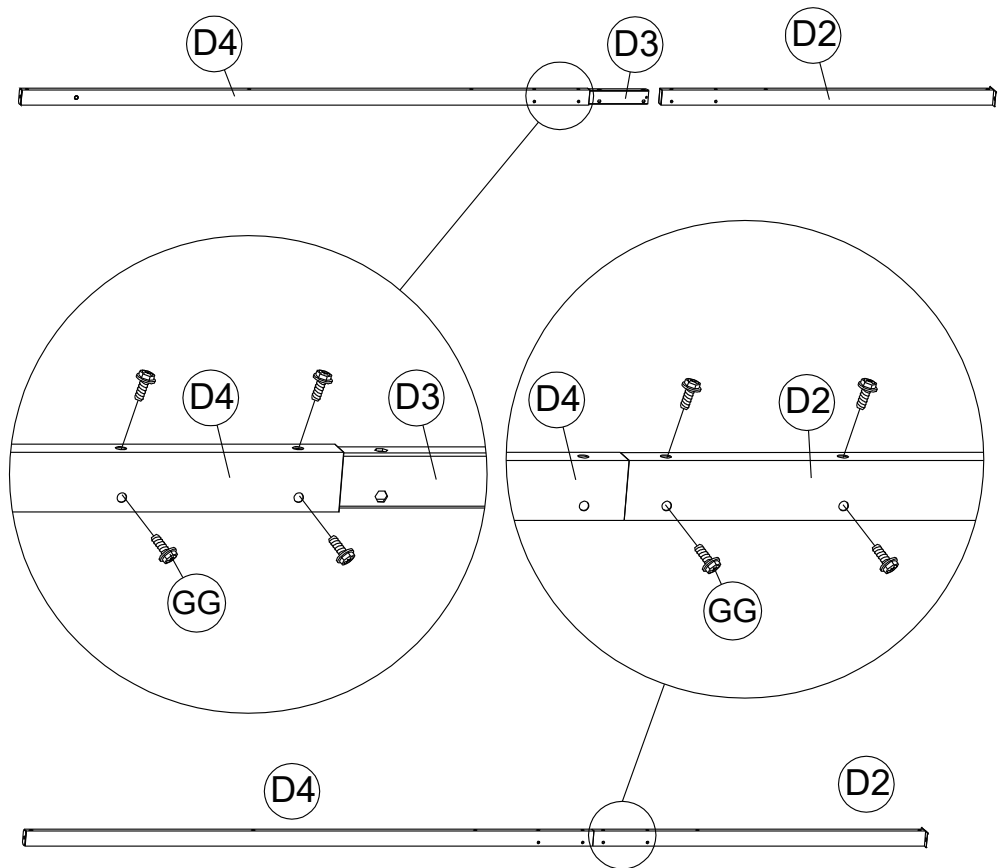

GG 8x

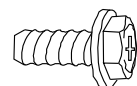

M6x15

STEP 14

Combine one end of the Intermediate Top Beam (E1) with the Top Beam Insert (E2) and tighten with M6 x 15(GG) bolts at the marked positions as shown in the illustration. Attach one end of the other Intermediate Top Beam (E1) to the Top Beam Insert (E2) and tighten with M6 x 15 bolts (GG) in the marked positions as shown in the figure.



(E1) 4x



(E2) 2x

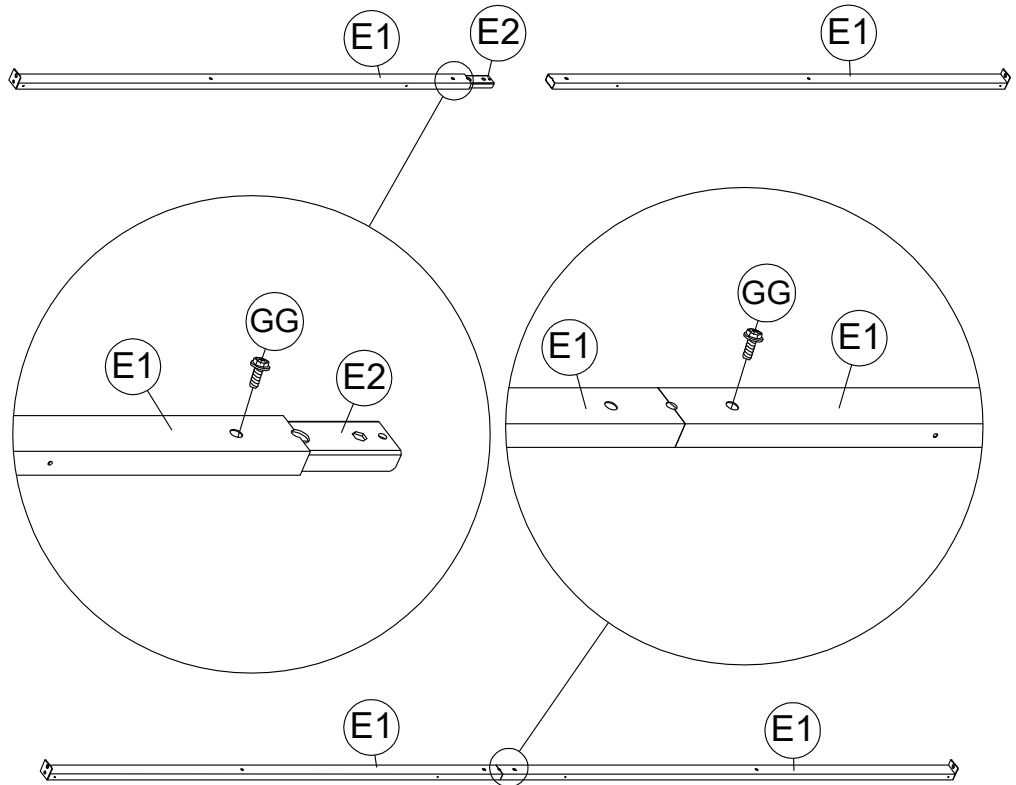

(GG) 4x

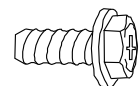

M6x15

STEP 15

Combine one end of the Intermediate Roof Beam (E3) with the Top Beam Insert (E2) and tighten with M6 x 15(GG) bolts at the marked positions as shown in the illustration.
 Combine one end of the Intermediate Roof Beam (E3) with the Top Beam Insert (E2) and tighten with M6 x 15 bolts (GG) in the marked positions as shown in the figure.
 Combine one end of the Upper and Lower Roof Beam (E4) with the Top Beam Insert (E2) and tighten with M6 x 15 bolts (GG) in the marked positions as shown in the figure.



E3 2x

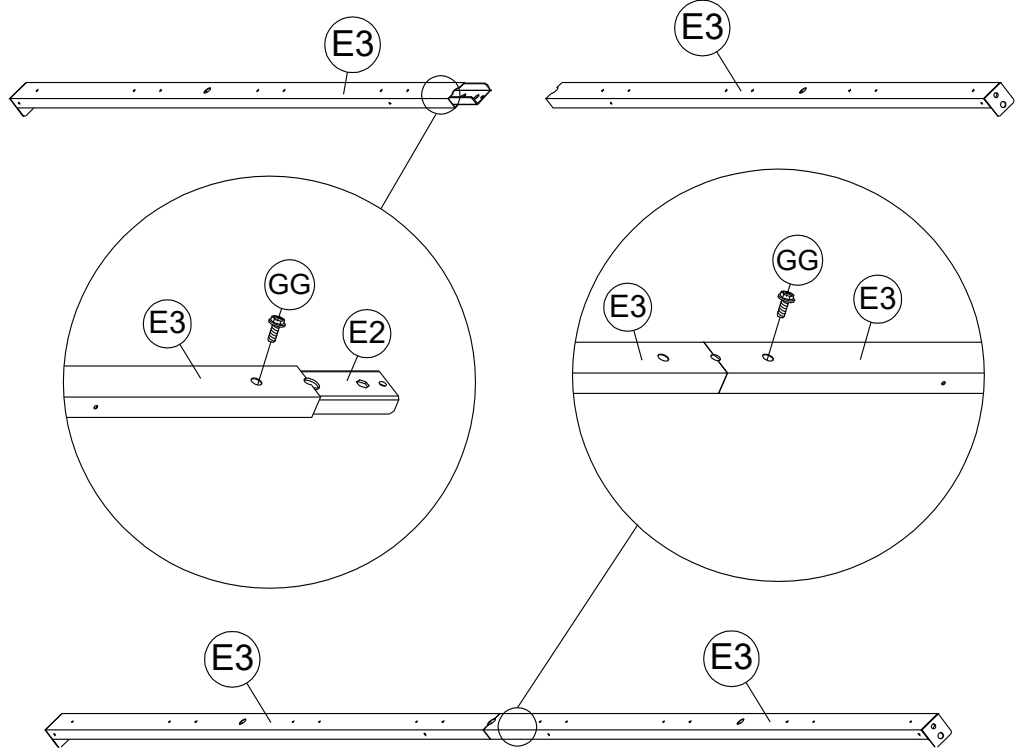

E2 3x

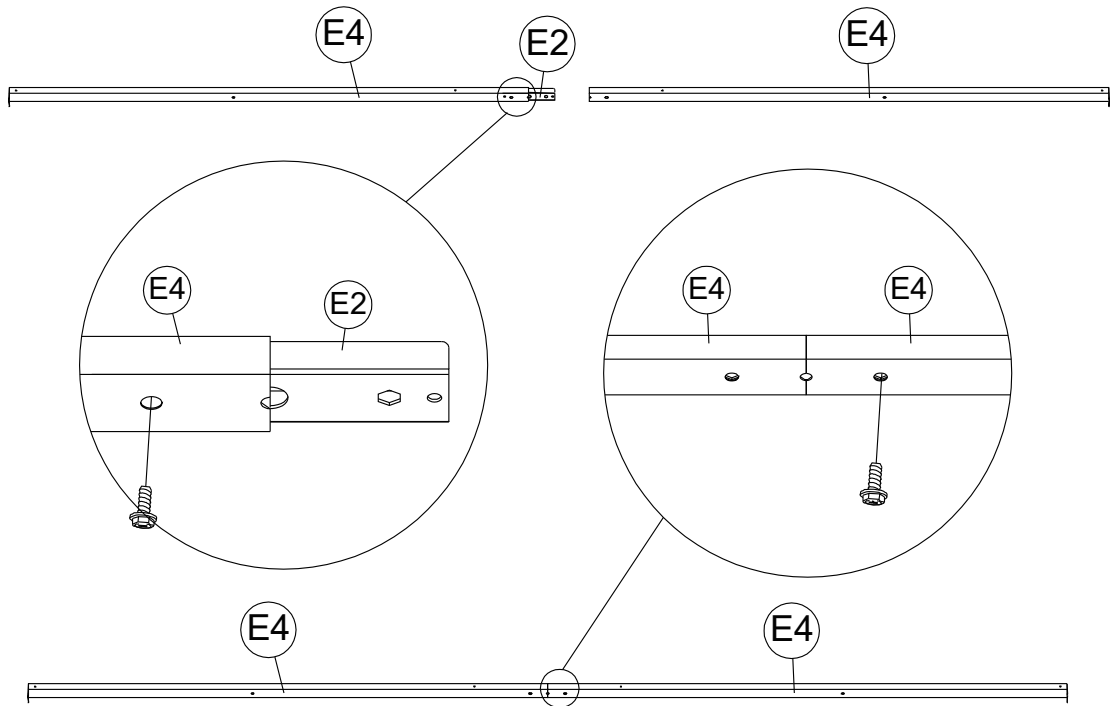

E4 4x

GG 6x

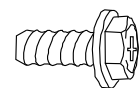

M6x15

STEP 16

Combine one end of the Front Cross Member Left (L2) with the Front Crossmember Insert (M2) and tighten with M6 x 15(GG) bolts at the marked positions as shown in the illustration.

Combine one end of the Front Cross Member Right (L1) with the Front Crossmember Insert (M2) and tighten with M6 x 15 bolts (GG) in the marked positions as shown in the figure.



L2 1x

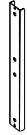

M2 1x



L1 1x

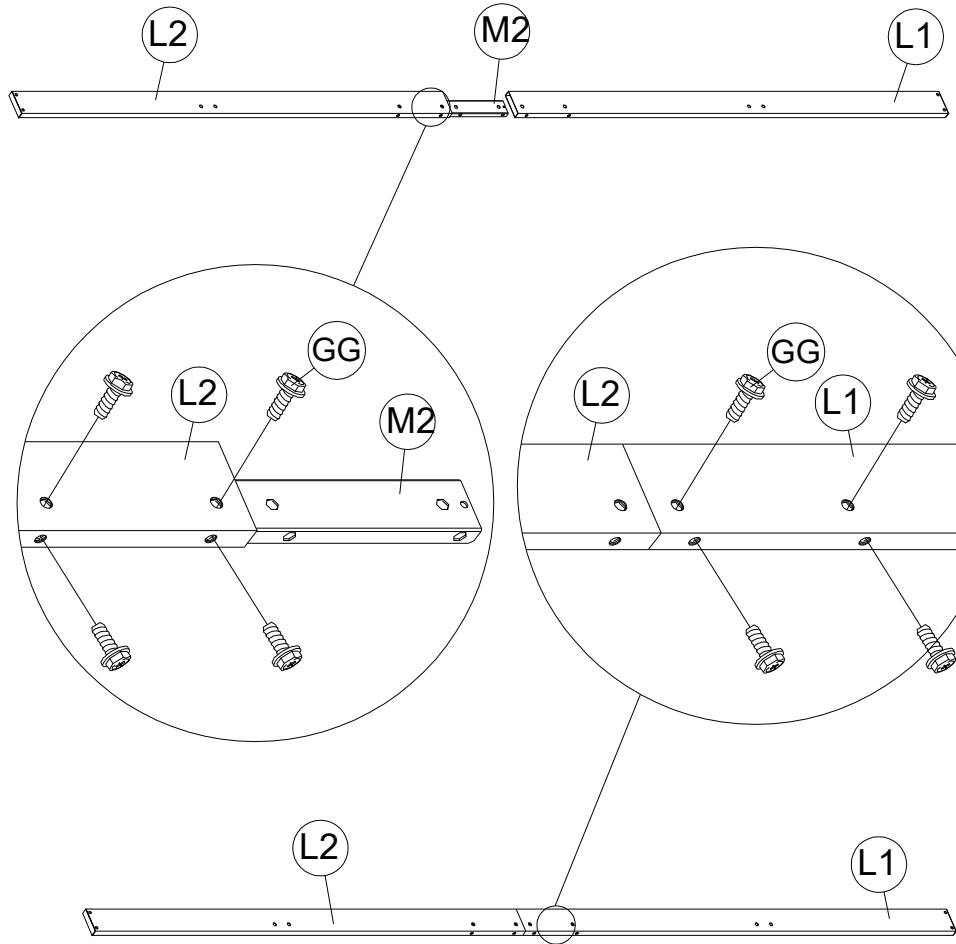

GG 8x

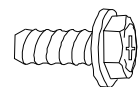

M6x15

STEP 17

Align the Columns (A1,A2) installed in steps 1 and 2 with the Beams (C1,C2) installed in step 8, align the holes on both sides, and tighten them with bolts M6×15 (GG). Then align the Columns (A5,A6) installed in steps 3 and 4 with the outside of the beams (C3,C4) installed in step 9 with the holes, and then align the Columns (A7,A8) installed in steps 5 and 6 with the holes on the inside of the Beams (C3,C4) and tighten them using the bolts (KK), and then fasten the Snap (BB) on the outside of the holes.

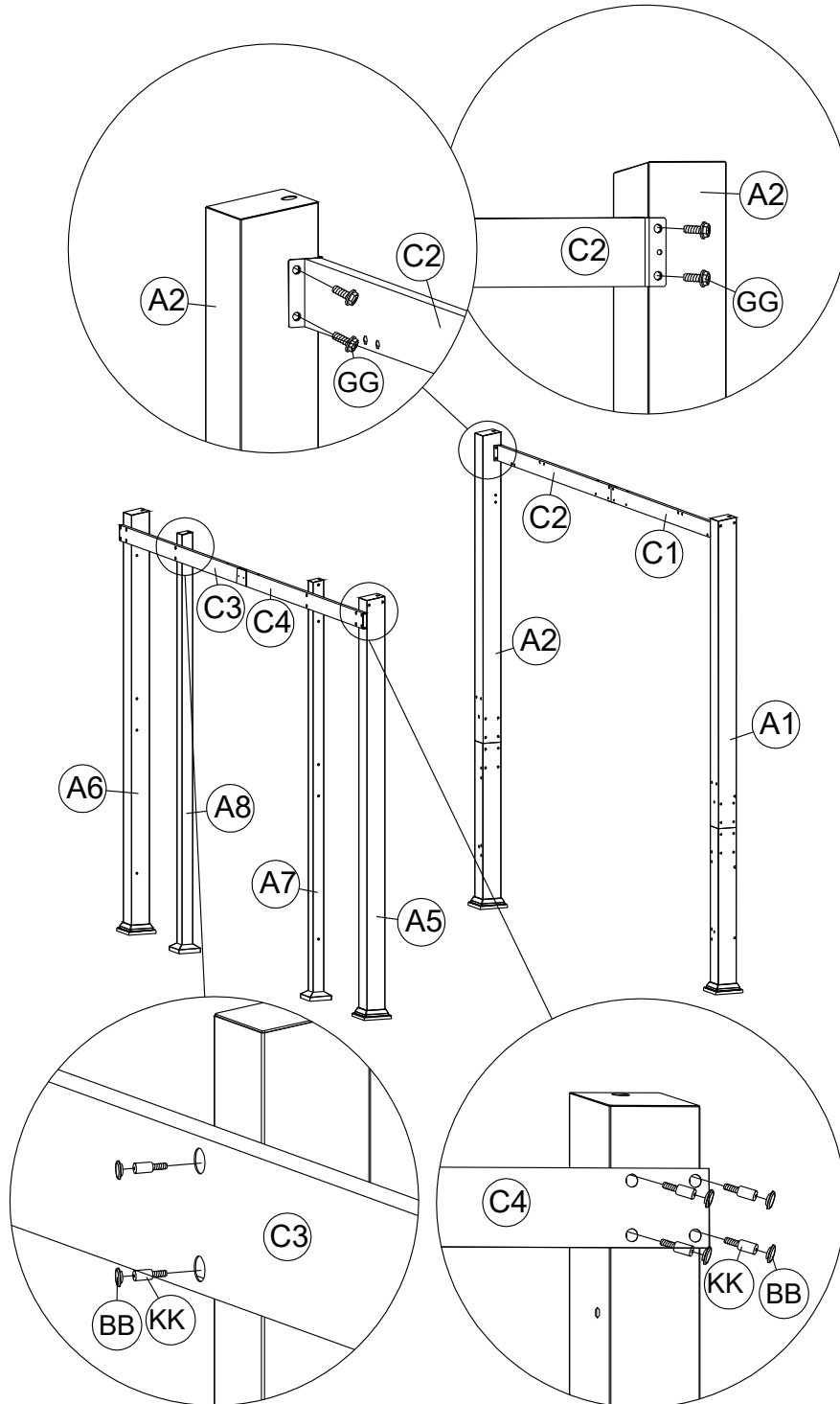

(BB) 12x



(KK) 12x

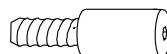

M6x35

(GG) 8x

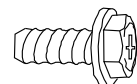

M6×15

STEP 18

Install the Left Crossbeam (C5,C6) installed by STEP10 and the Right Crossbeam (C7,C8) installed by STEP11 on the left and right sides of the frame as shown in the figure, and use the straight head bolts M6×35(KK) to lock them on the two sides of the columns, and then fasten the Snop (BB) on the outside of the bolts.

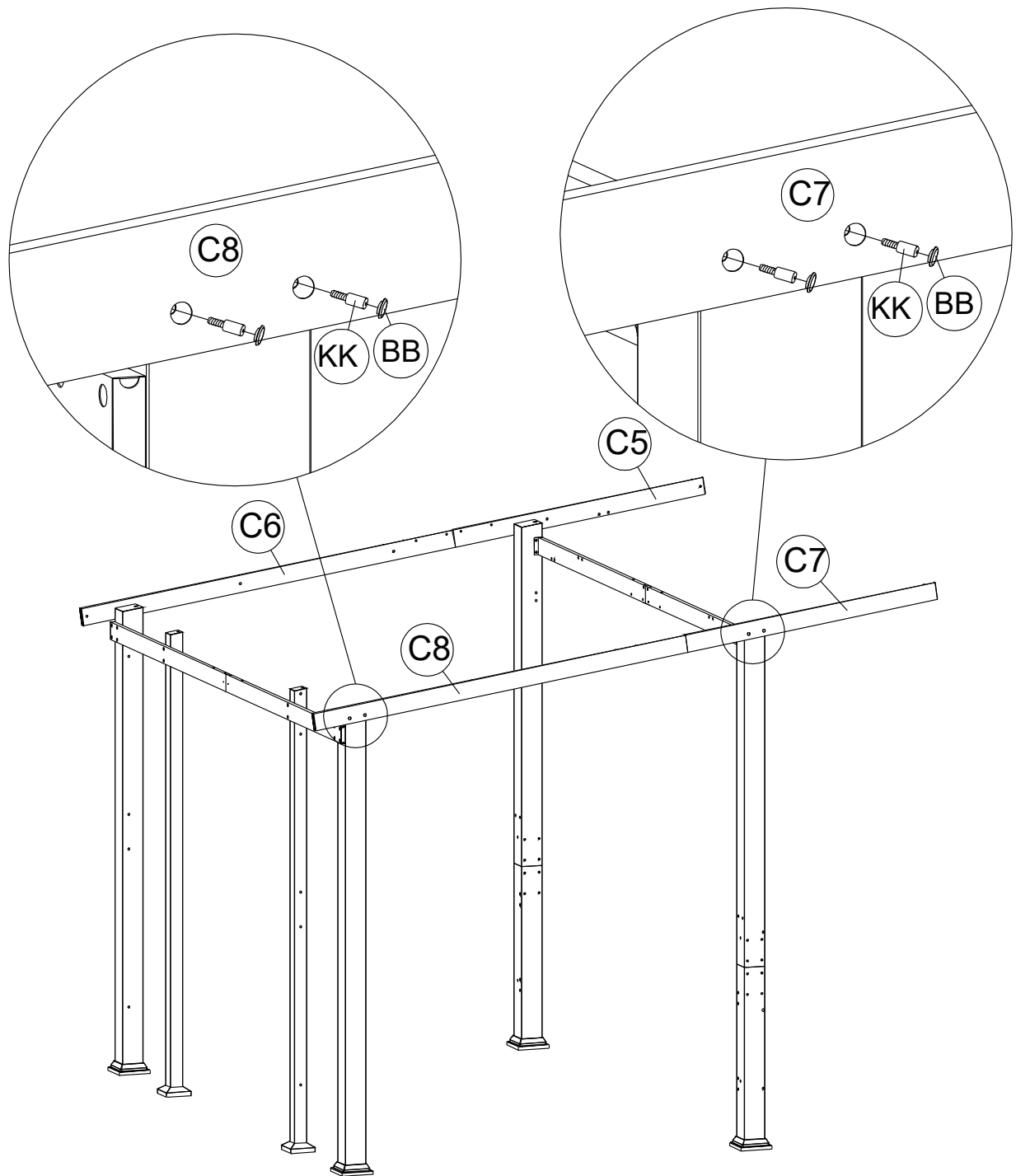

BB 8x



KK 8x

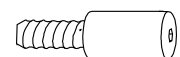

M6x35

STEP 19

Install the Long Diagonal Brace 2 (H2) in front of the Column KD Upper 2 (A2) and on the inside of the Side Short Crossbar Left (C5), and tighten it using bolts M6 x 15 (GG). Install the Long Diagonal Brace 1 (H1) in front of the Column KD Upper 1 (A1) and on the inside of the Side Short Crossbar Right (C7), and tighten it using bolts M6 x 15 (GG). Install the Short Diagonal Brace 2 (H4) on the right side of the Column KD Upper 2 (A2) and on the inside of the Middle Beam Left (C2), and tighten it using bolts M6 x 15 (GG). Install the Short Diagonal Brace 1 (H3) on the right side of the Column KD Upper 1 (A1) and on the inside of the Middle Beam Right (C1), and tighten it using bolts M6 x 15 (GG).



H2 1x



H1 1x



H4 1x

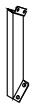

H3 1x

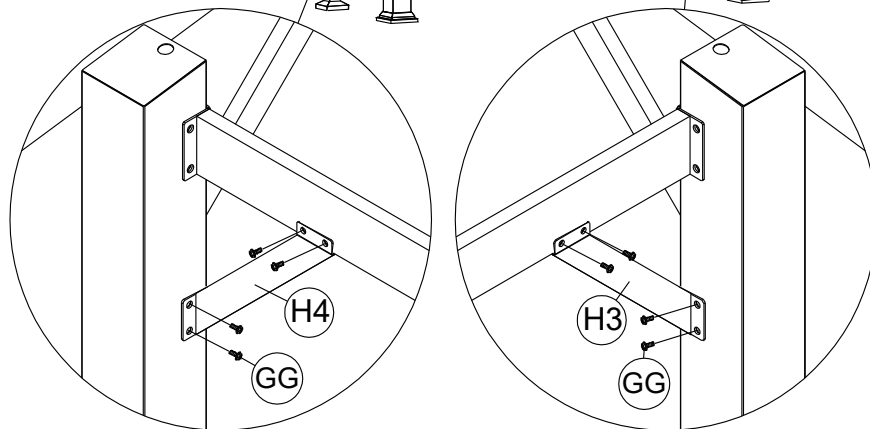
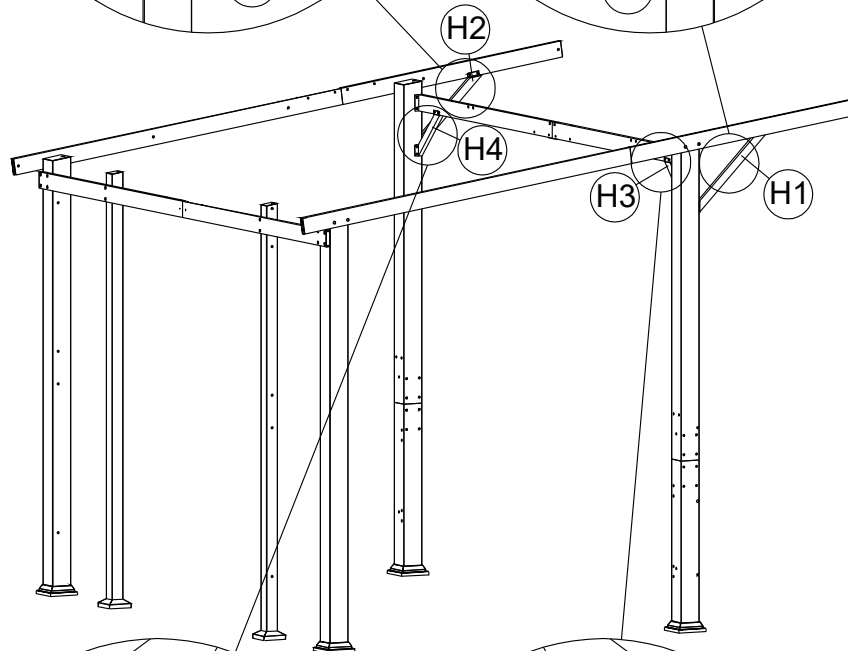
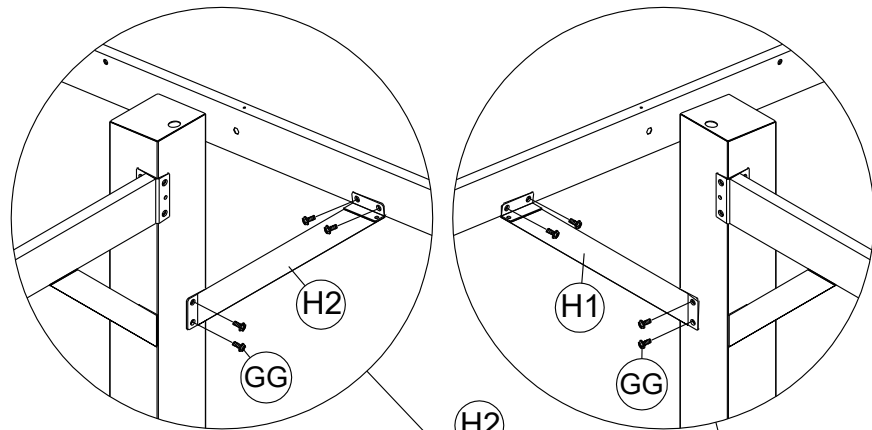

GG 16x

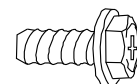

M6x15

STEP 20

Attach the Intermediate Beam Connector on (H5) to the Middle Beam (C1,C2) as shown in the figure, and tighten them using bolts M6×15 (GG).

Attach the Under Intermediate Beam Connector (H6) to the middle portion of the Rear Crossbar (C3,C4) as shown in the figure, and tighten it using bolts M6×15 (GG).



H5 3x

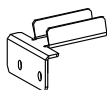

H6 1x

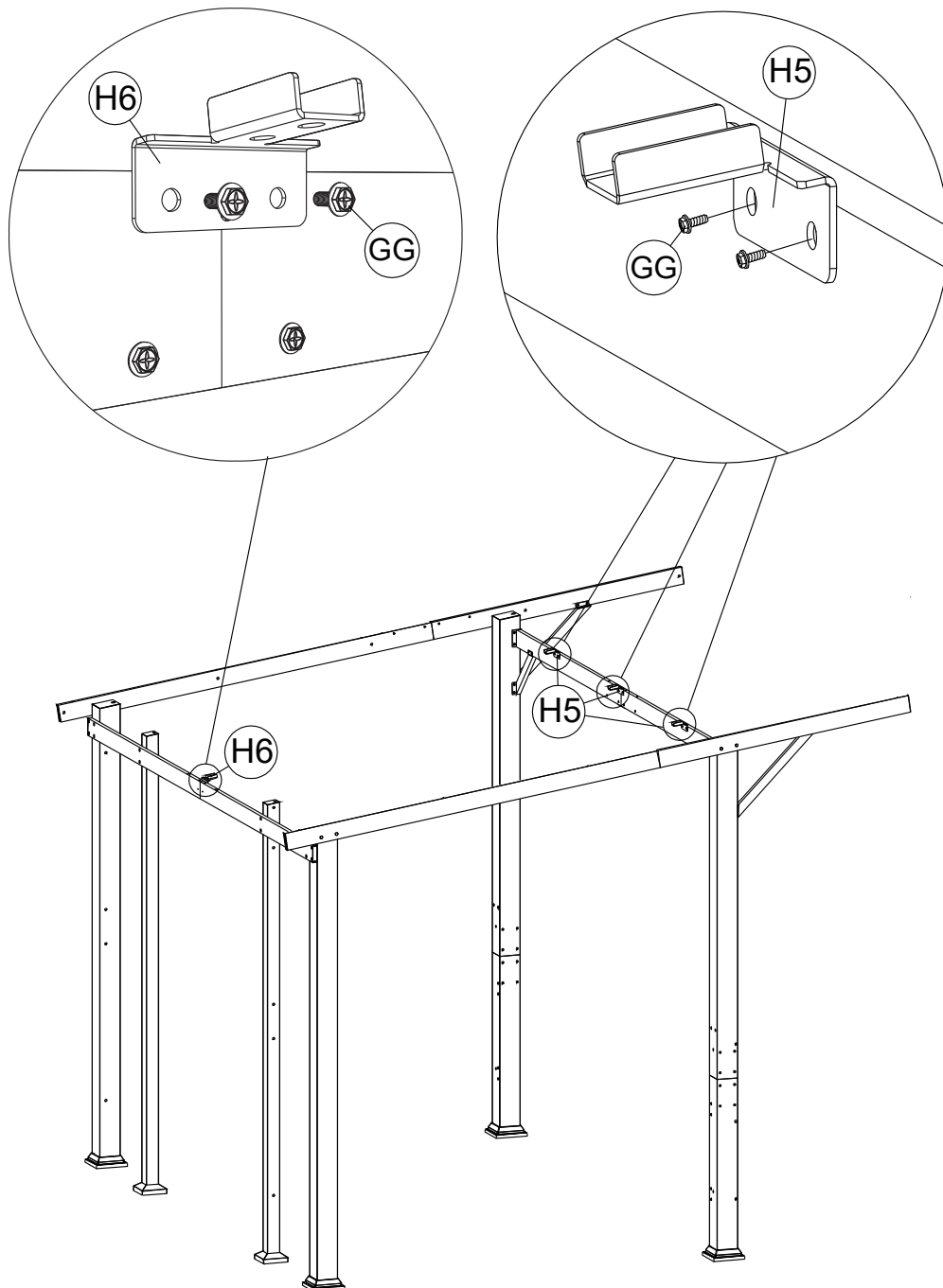

GG 8x

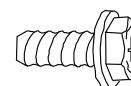

M6x15

STEP 21

Install the two Beams (D1,D2) installed by STEP12 on both sides of the Columns (A7,A8), tighten the bolts M6×30 (QQ) for the connecting column part, and tighten the bolts M6×15 (GG) for the Intermediate Beam Connector on (H5) part.
Attach the STEP13 mounted Intermediate Beam (D4,D2) to the Under Intermediate Beam Connector (H6) and the up Intermediate Beam Connector (H5) from the previous step as shown in the figure, and tighten them with bolts M6×15 (GG).

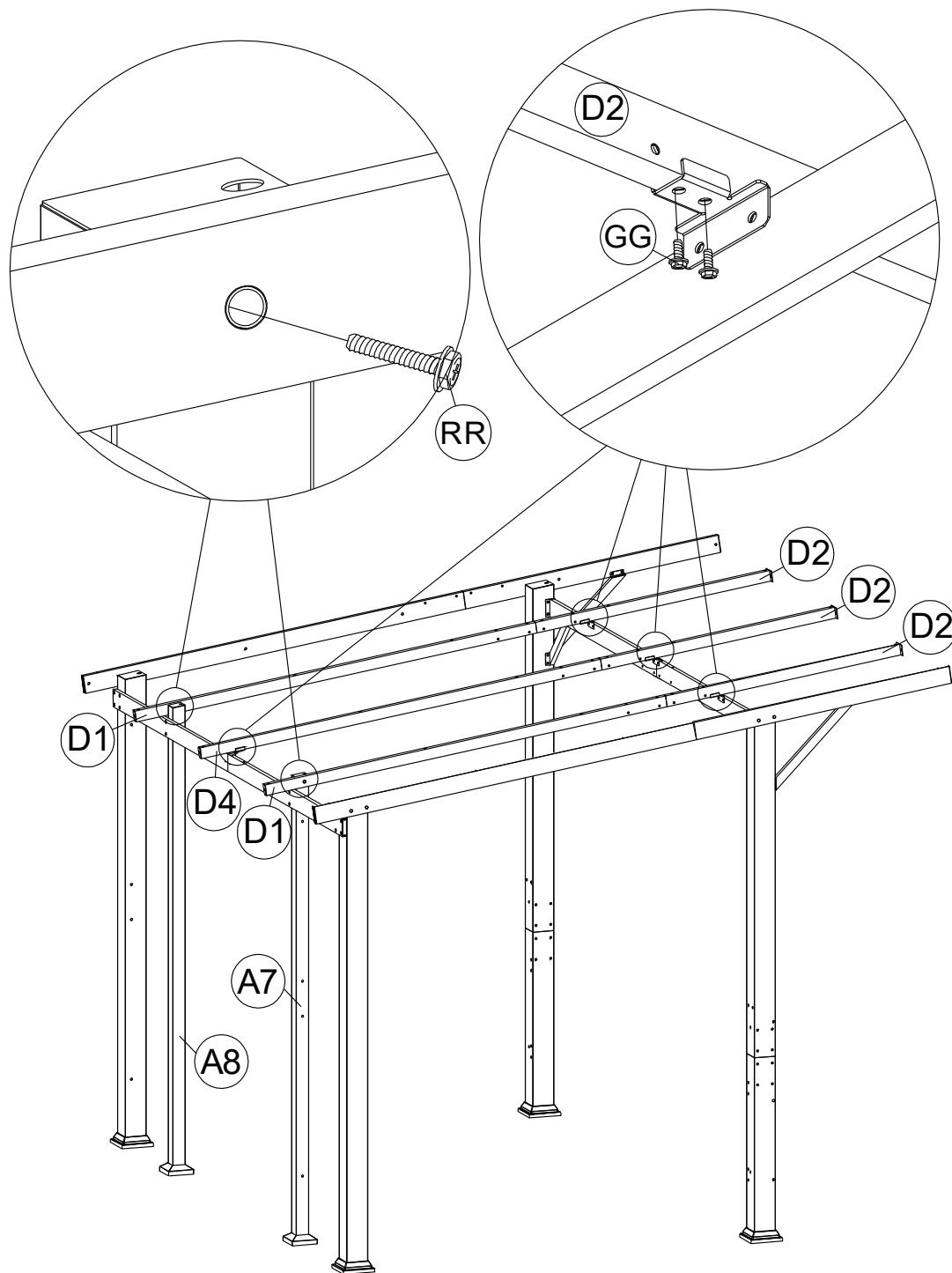

GG 8x

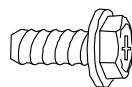

M6x15

RR 2x

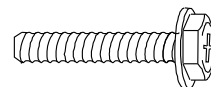

M6x45

STEP 22

Install the STEP16 mounted Front Cross Member (L1,L2) on the front side of the Side Short Crossbar (C5,C7) as shown in the picture, align the holes, and tighten them using bolts M6×35 (KK), and cover the outer holes using the Snop (BB). The inside of the Front Cross Member (L1,L2) is aligned with the front side lug holes of the Short Intermediate Beam (D2) and tightened using bolts M6×15 (GG).

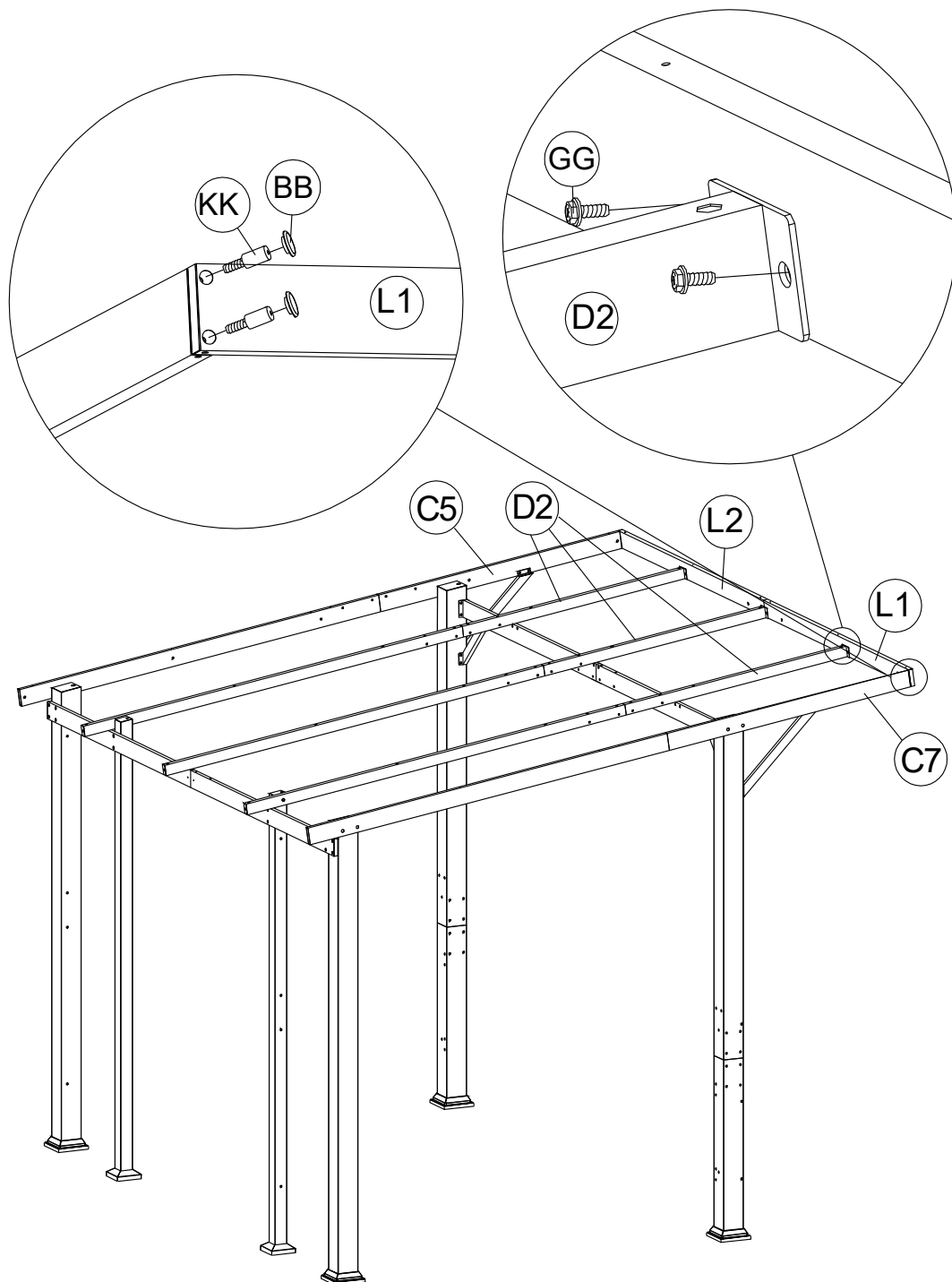

GG 6x

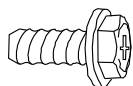

M6x15

BB 4x



KK 4x

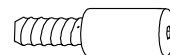

M6x35

STEP 23

Install the STEP15 mounted Roof Beam (E4) at the ends of the Side Long Beam (C5,C6) and Side Short Crossbar (C7,C8) as shown in the figure, and tighten using bolts M6×15 (GG).
Install the STEP15 mounted Intermediate Roof Beam (E3) in the middle of the two side cross members, as shown in the figure, and tighten with bolts M6×15 (GG).
Install the 2 Intermediate Top Beam (E1) installed by STEP14 at the ends of C5 and C7 and at the ends of C6 and C8 as shown in the figure, and tighten them with bolts M6×15 (GG).
Finally, use bolt M6×35 (KK) to connect the center hole of the above crossbeam to the lower crossbeam.

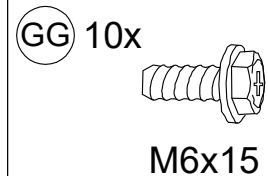
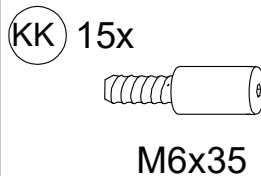
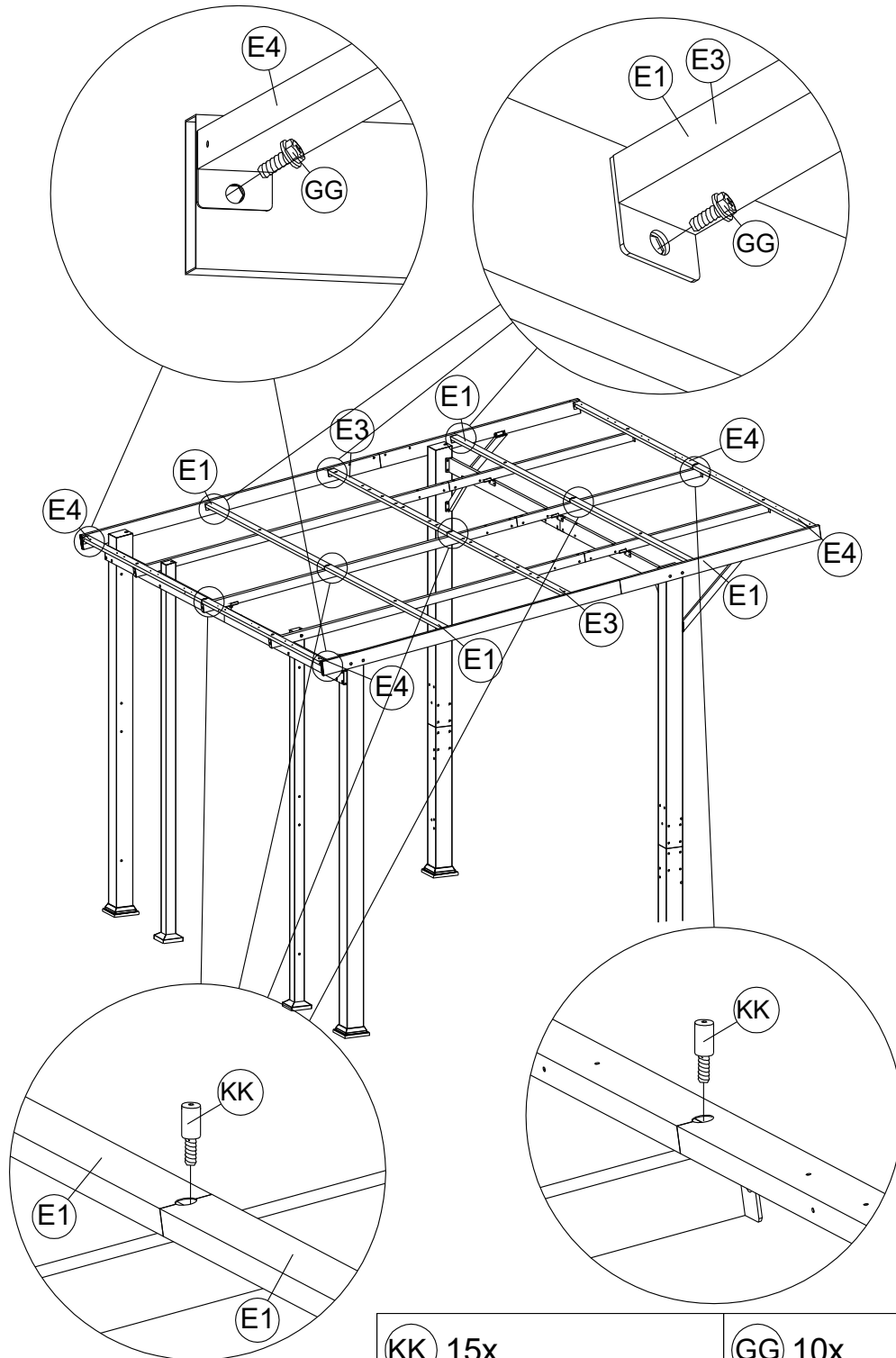

STEP 24

Install the 2 Long Screens (J2) between the Column 2 (A6) and Small column 2 (A8) as shown in the sequence, and tighten them using bolts M6 x 25. Install the 2 Long Screens (J2) between the Column 1 (A5) and the Small column 1 (A7) in the same order, and tighten the bolts M6x25.

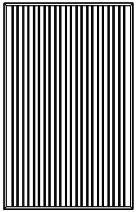

J2 4x

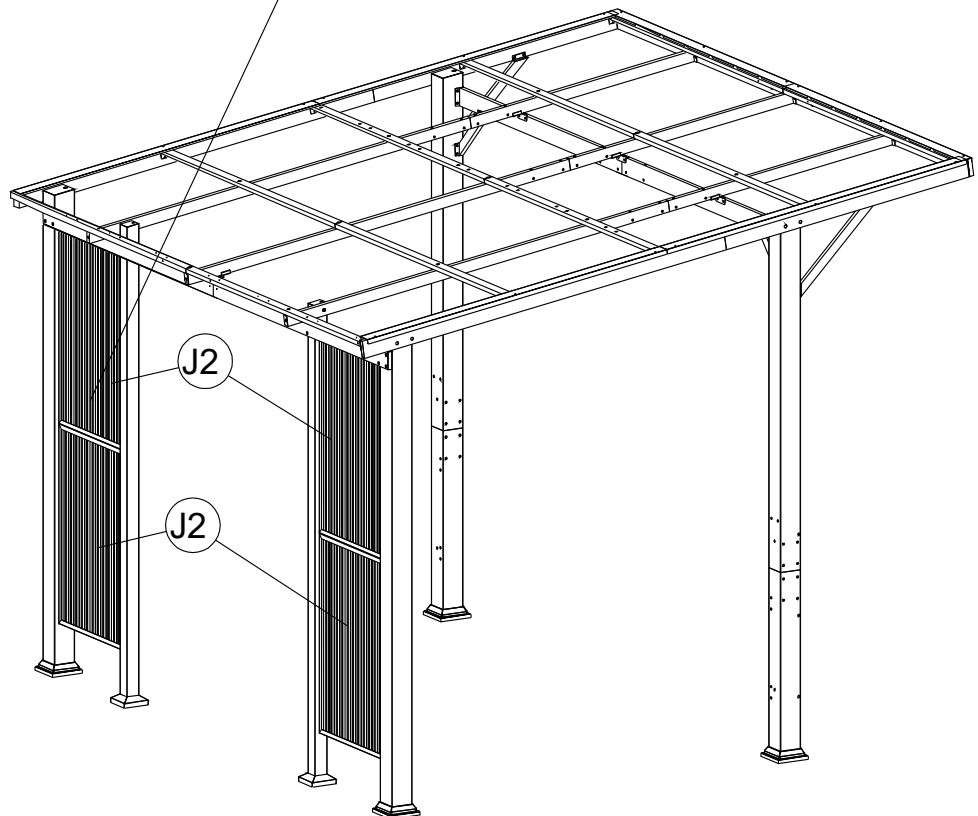
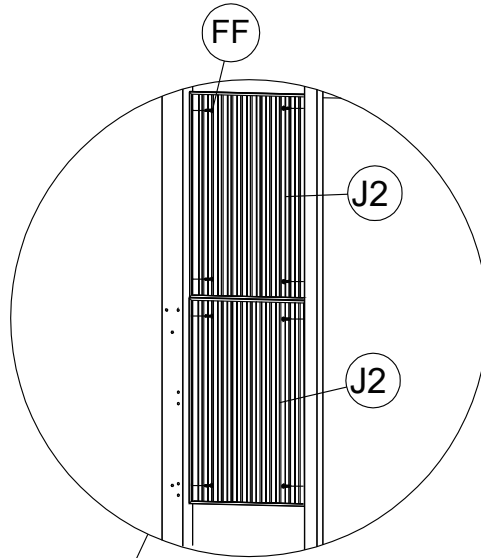

FF 16x

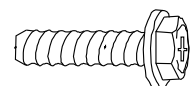

M6x25

STEP 25

Install the Countertop (K3) between the Column 2 (A6) and the Column KD Upper 2 (A2), with the holes below the countertop, in the position shown, and tighten using bolts M6 x 30 (QQ).

Install the other Countertop (K3) between the Column KD Upper 1 (A1) and the Column 1 (A5) using the same method.



(K3) 2x

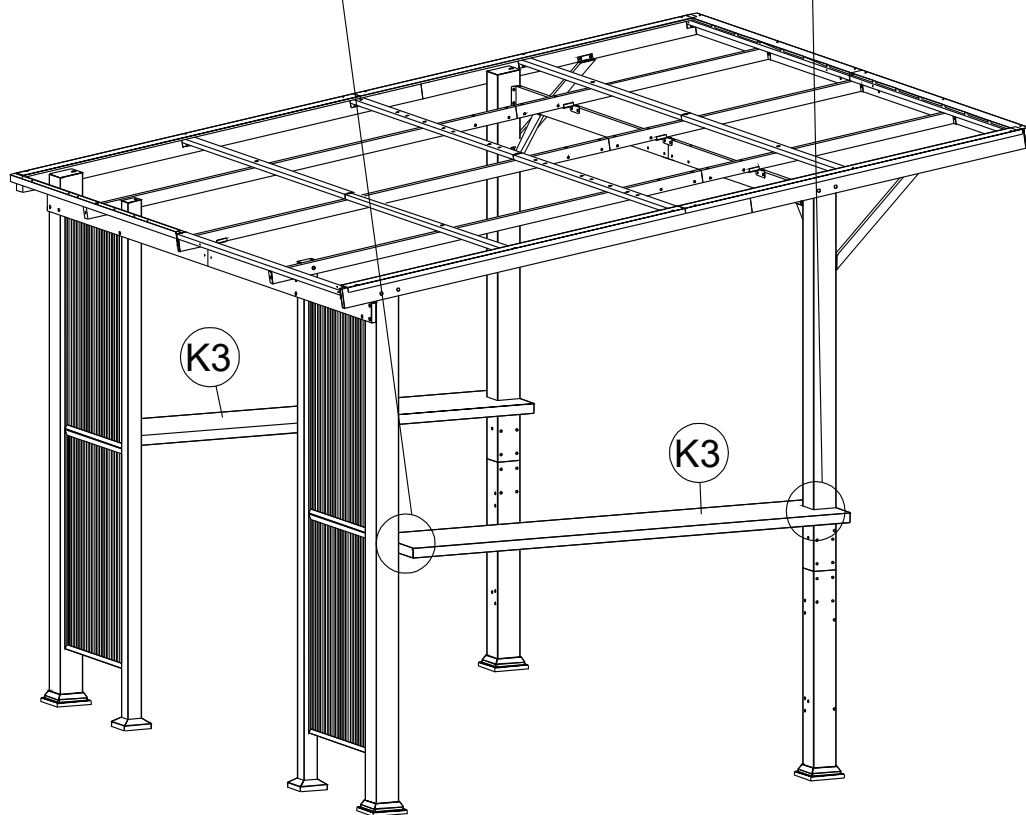
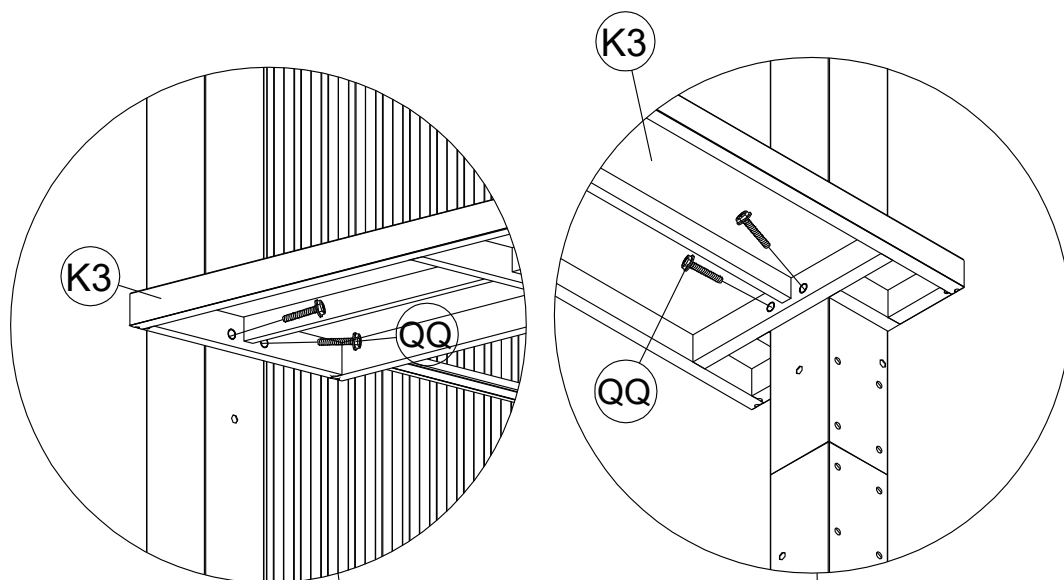

(QQ) 8x

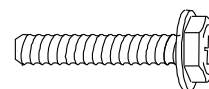

M6x30

STEP 26

Snap both sides of the 3 Short Screens (K1) into the Screen Reinforcement Plate (K2), align the holes and tighten all the holes on both sides using bolts M6 x 15 (GG). Then use bolt M6 x 30 (QQ) to go through the holes on the side of K1 and tighten the other end using spacer M6 (LL) and nut M6 (DD). Install the remaining short screens again using the same steps.

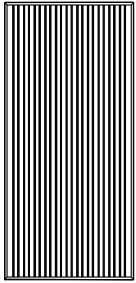

(K1) 6x



(K2) 4x

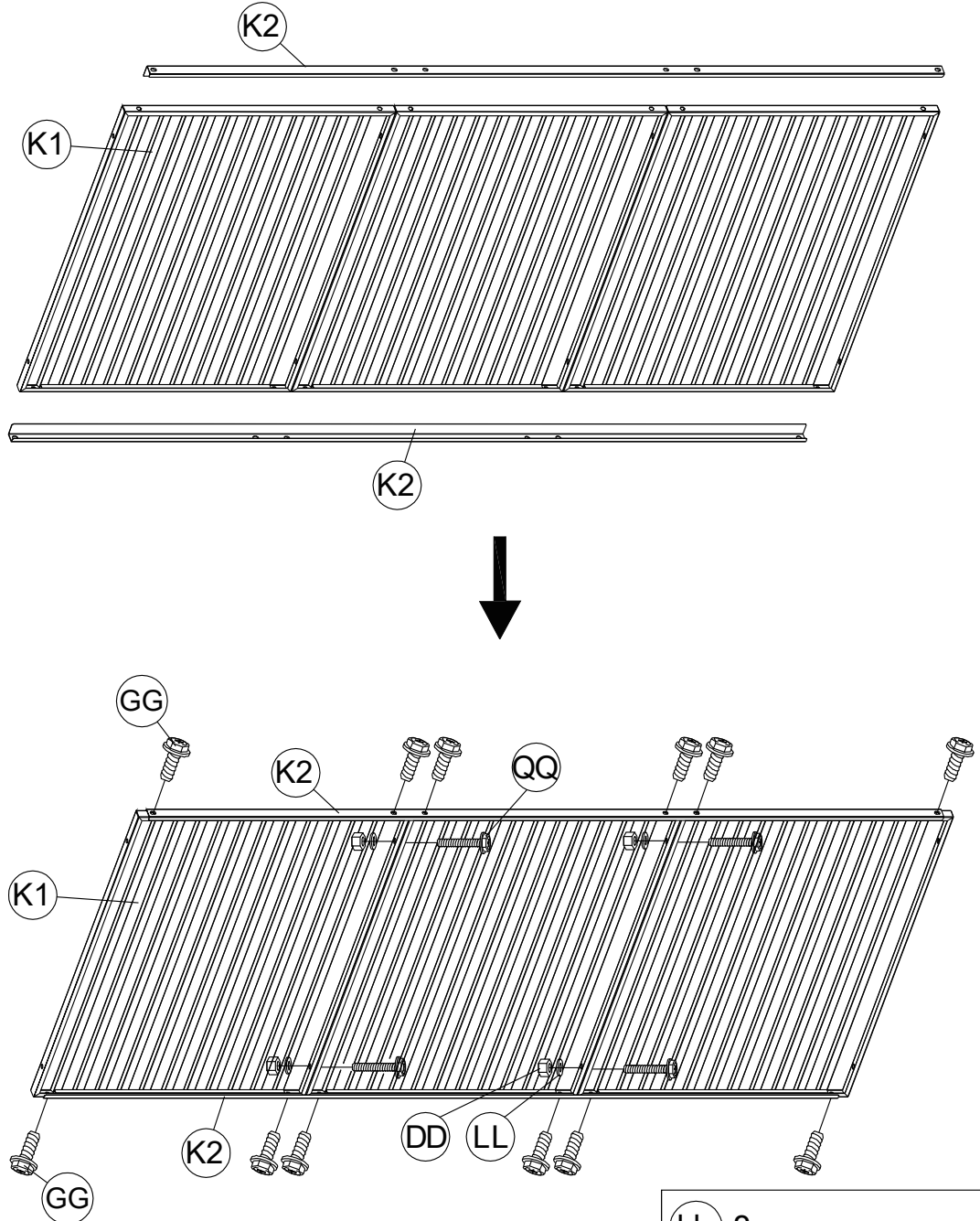

(LL) 8x



(DD) 8x

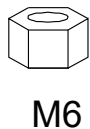

M6

(QQ) 8x

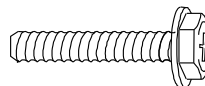

M6x30

(GG) 24x

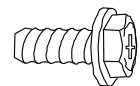

M6x15

STEP 27

Install one set of short screen assemblies, installed by STEP27, between the Column 2(A6) and the Column KD Upper 2 (A2), as shown in the diagram. Another set of short screen assembly, mounted between Column 1 (A5) and Column KD Upper 1 (A1), tighten with bolts M6×25 (FF).

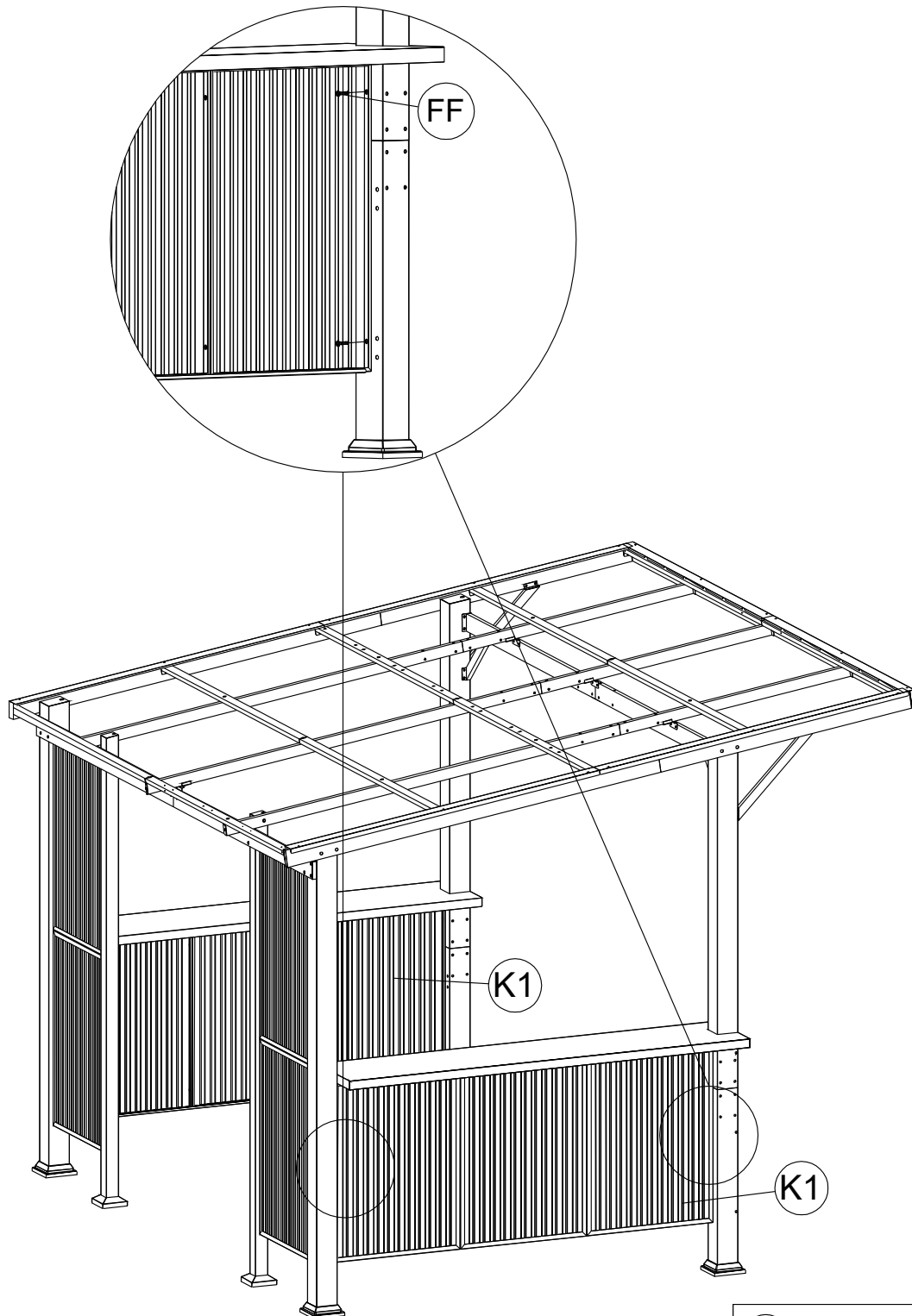

FF 8x

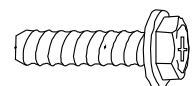

M6x25

STEP 28

Connect the Partition (K5) with the Bulkhead Connector 1 (M3) and the Bulkhead Connector 2 (M4) as shown in the figure, align the holes, and tighten them using the bolts M6 x 15 (GG). Repeat the steps to install the other bulkhead and bulkhead connector.

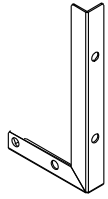

M3 2x

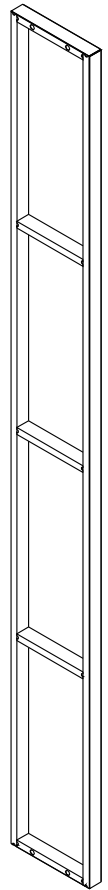

K5 2x

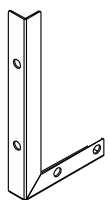

M4 2x

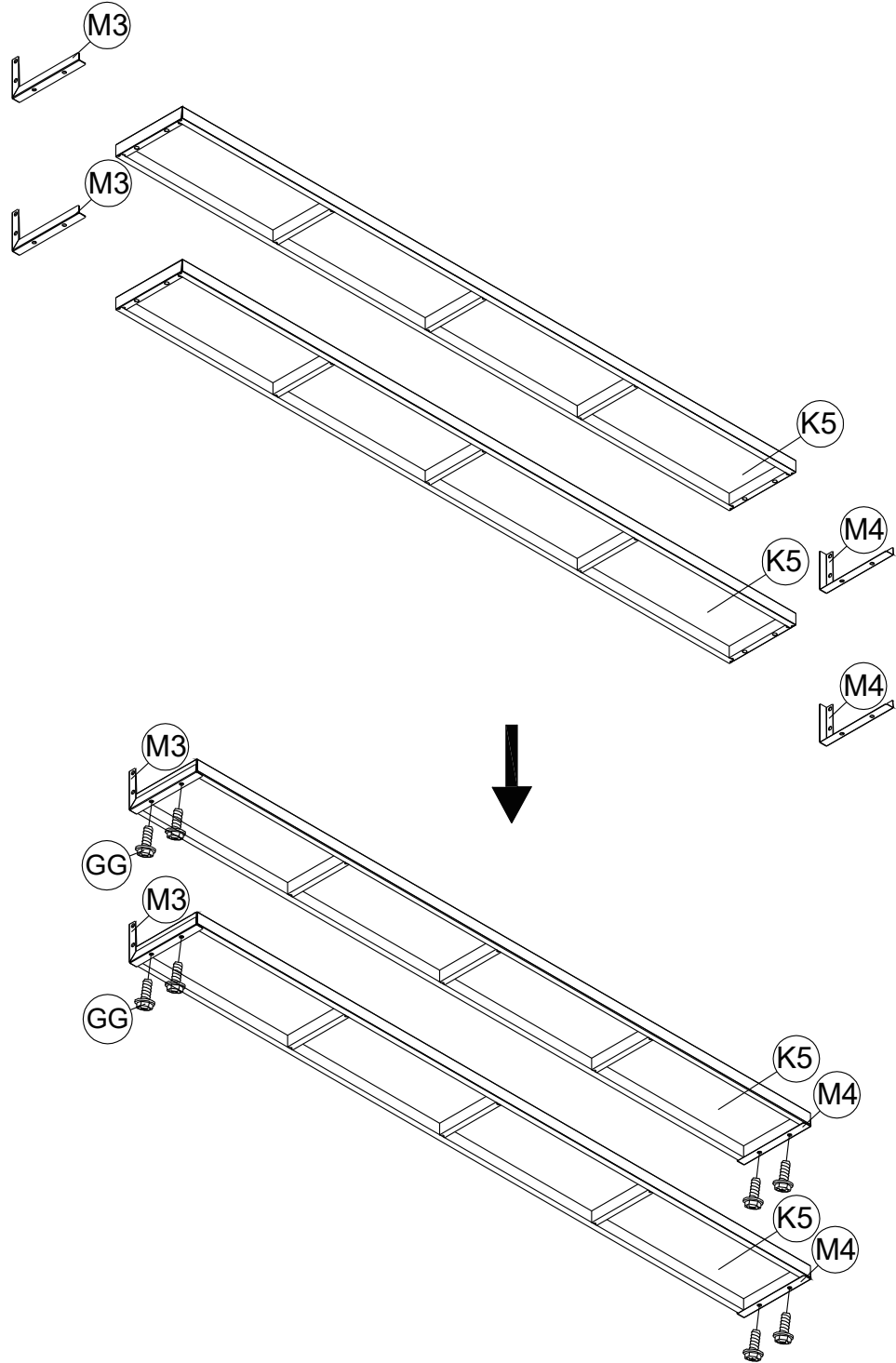

GG 8x

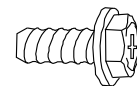

M6x15

STEP 29

Between Column 1 (A5) and Column KD Upper 1 (A1), install the STEP28 mounted assembly by aligning the holes in M4, M3, and the lower side of the column and tightening them with M6 x 15 (GG) bolts. Of course, it is also possible to install both spacer assemblies in the same way between column 2 (A6) and column KD upper 2 (A2).

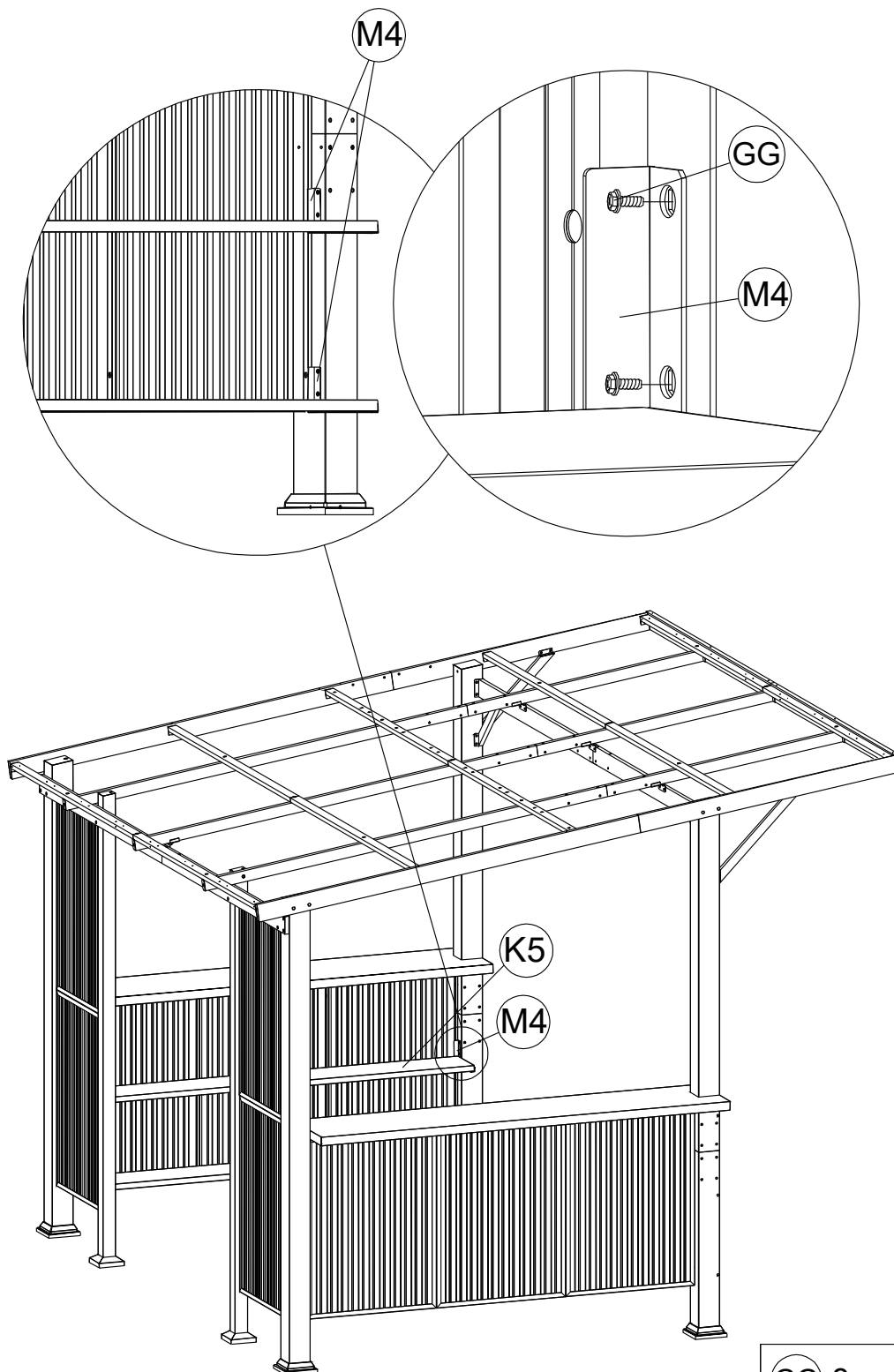

GG 8x

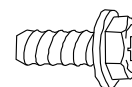

M6x15

STEP 30

The following is an example of a small countertop mounted on the left side. First, install the Small Countertop Connection Tab (B5) in the left hole at the bottom of the Small Countertop (K4) as shown in the illustration, and tighten the bolts (GG). Fasten the small countertop connecting piece to the Short Column (A9) and tighten using bolts M6 x 15 (GG), splice the Small Countertop (K4) according to the diagram, align the holes on the sides of the Small Countertop (K4) with the holes on the sides of the Countertop (K3), and tighten using bolts M6x25 (FF).

Note: If it is to be mounted on the right side of the tent, the mounting sequence needs to be symmetrically mounted on the other side.



B5 1x

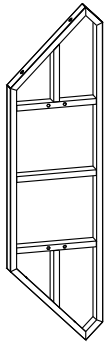

K4 1x

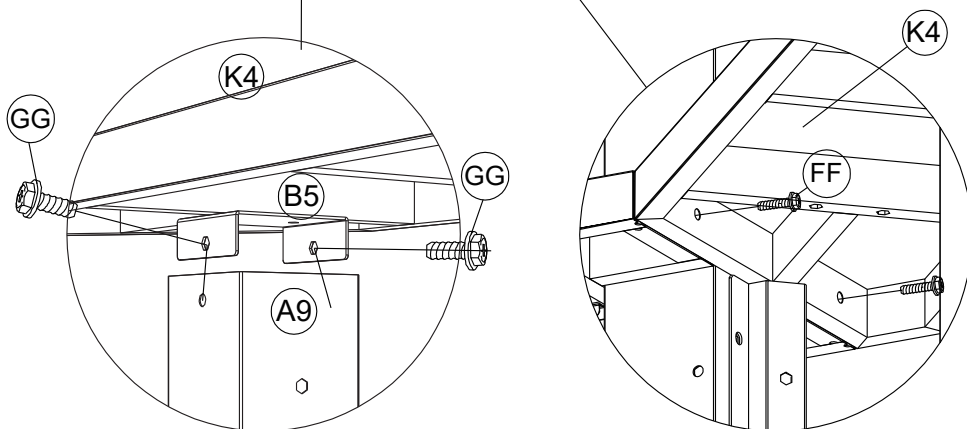
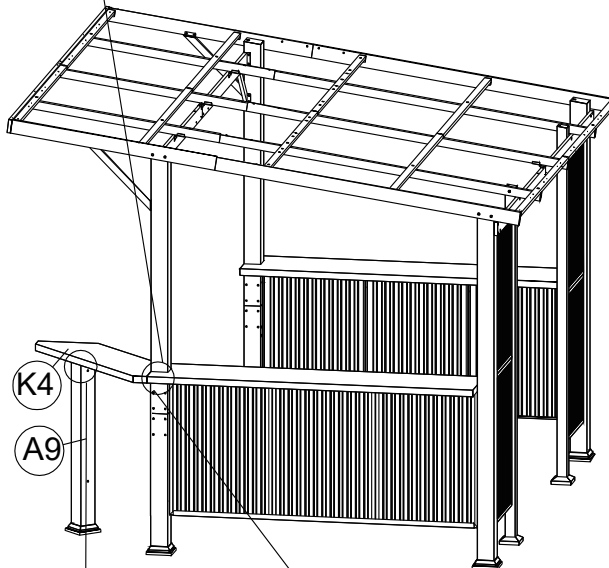
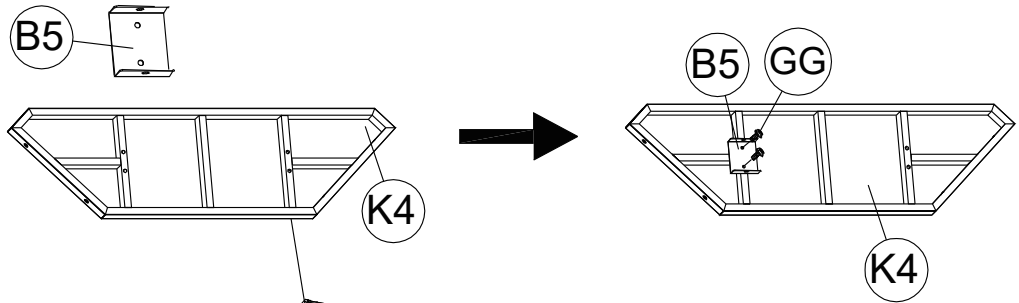

GG 4x

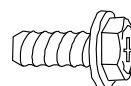

M6x15

FF 2x

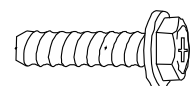

M6x25

STEP 31

Attach the Beveled Edge Reinforcement (J1) to the Column KD Upper 2 (A2), paying attention to the inside and outside, and position it as shown in the illustration, and tighten it using the bolts (GG).



J1 1x

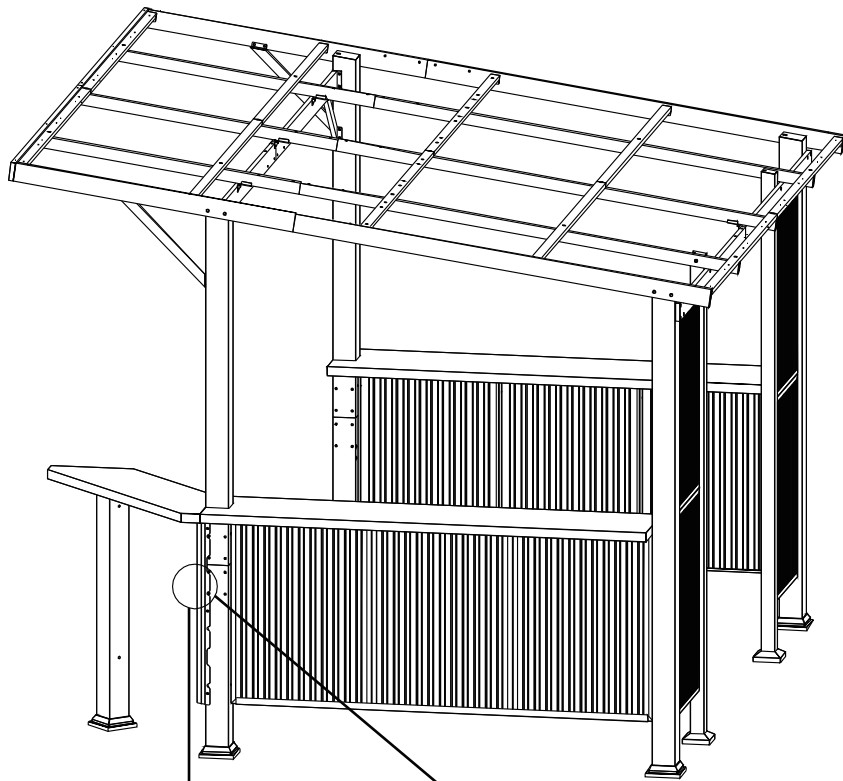

OUTSIDE

INSIDE

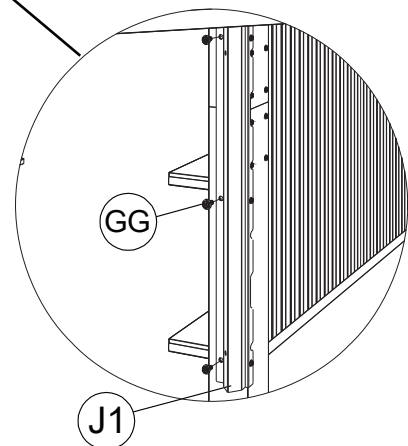
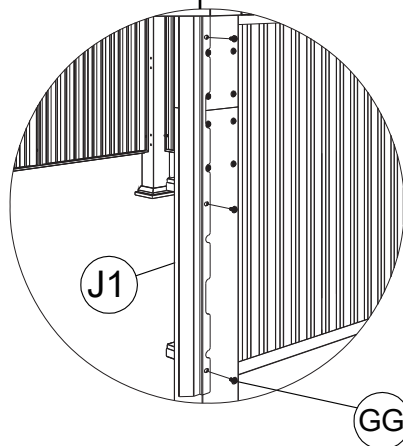

GG 6x

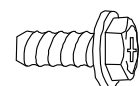

M6x15

STEP 32

Align the holes on both sides of the Short Screen (K1) with the holes on the sides of the Beveled Edge Reinforcement (J1) and the Short Column (A9) and tighten with bolts M6 x 25 (FF).

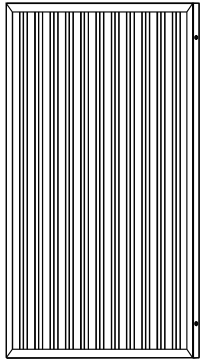

(K1) 1x

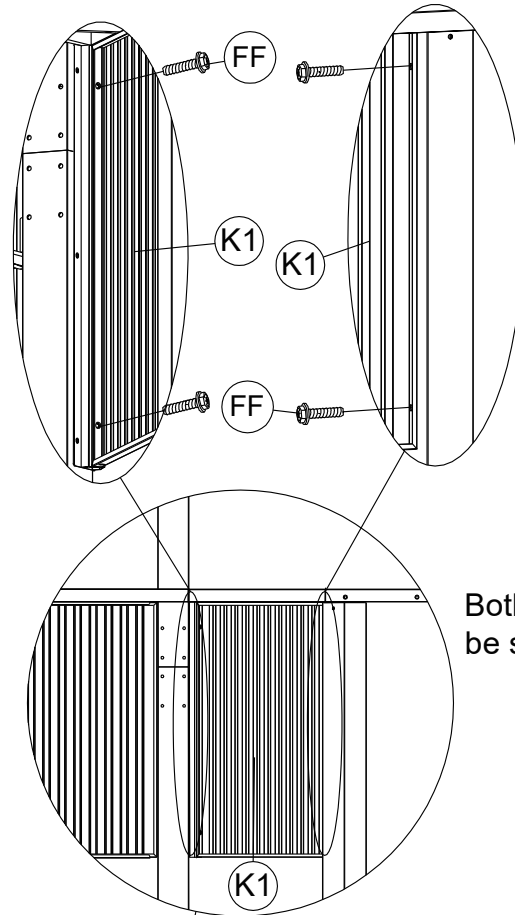

Both sides need to be secured with screws.

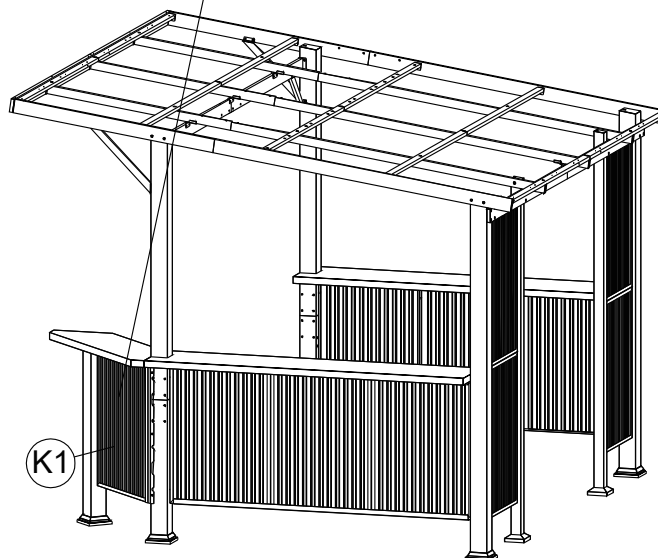

(FF) 4x

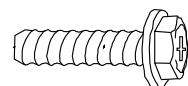

M6x25

STEP 33

Installation of the Roof (Q) need to pay attention to the order, first install the sloped top lower cover piece, starting from one side side of the order of installation, installation, pay attention to align the cover piece with the rear cross member of the hole alignment, use screws M4 × 16 (AA) tighten. Then install the slant top upper side cover piece, the slant top upper cover piece needs to be pressed against the lower cover piece, as shown in the picture, align the upper side of the cover piece with the holes in the front cross member and tighten it using screws M4×16 (AA). Finally, install the Layer (S) at the cover piece cover, align the holes to install the pressure strip, and tighten it using the bolt (CC) set into the gasket (LL).

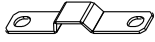

(S) 8x

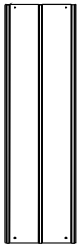

(Q) 14x

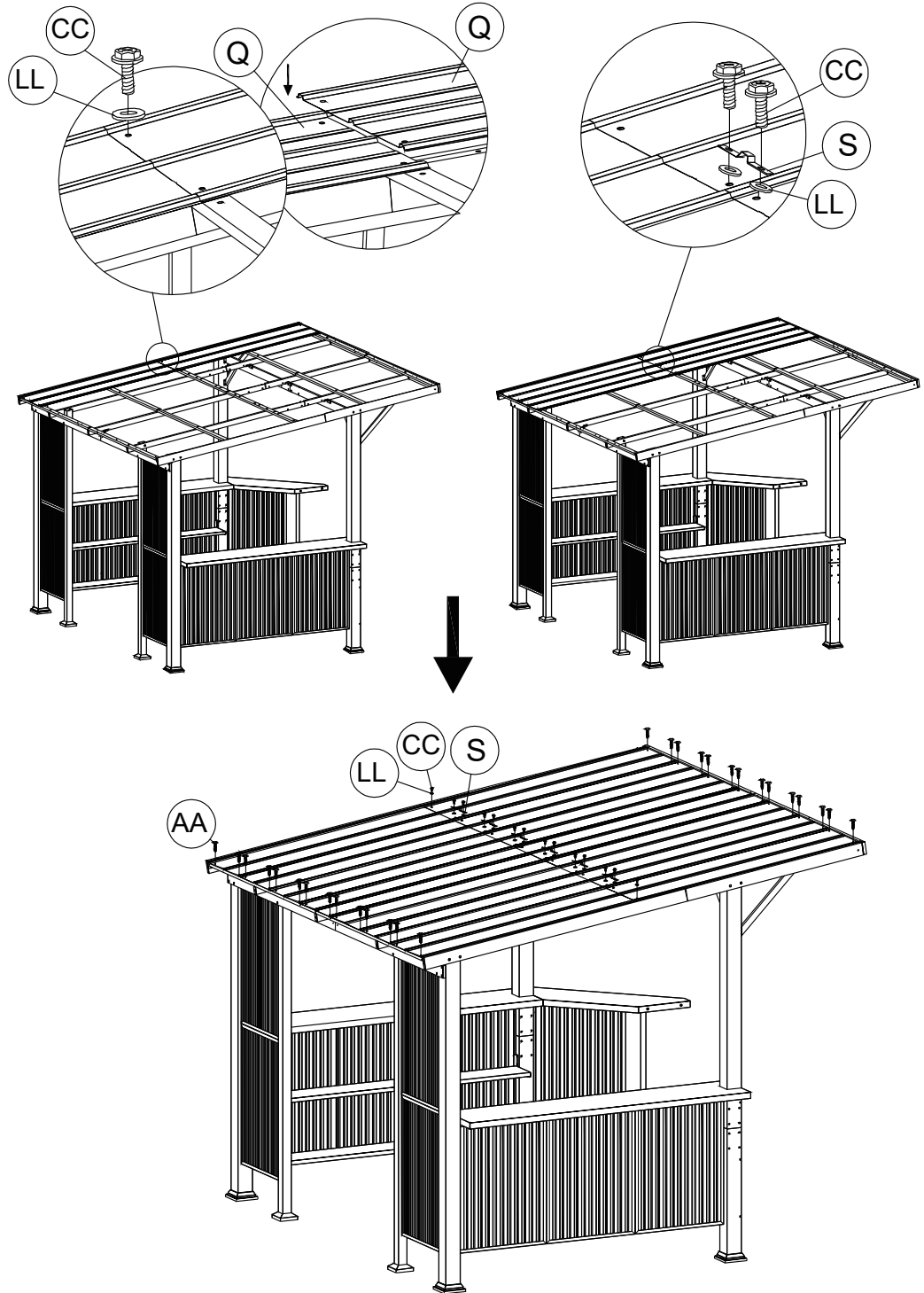

(MM) 14x



M6

(AA) 28x



M4x16

(CC) 14x

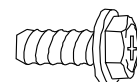

M6x20

STEP 34

Place the Side Baffle (F5) over the side cross member and cover piece, align the lower holes and tighten using screws M4 x 16 (AA).



F5 4x

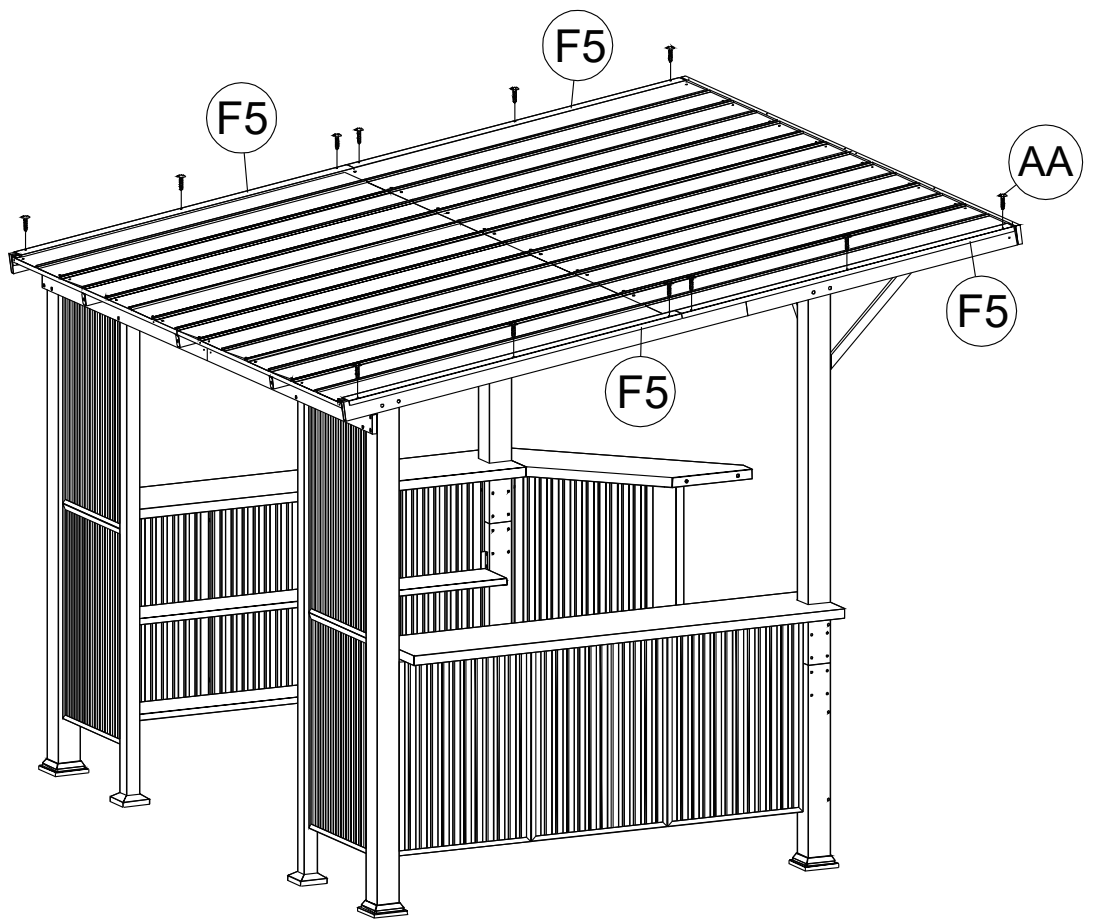

AA 12x



M4x16

STEP 35

Install in order as shown, install the Upper Pressure Bar Left (F4) on the left side of the front cross, and the Upper Pressure Bar Right (F3) on the right side of the front cross; install the Lower Baffle Left (F1) on the left side of the rear cross, and the Lower Baffle Right (F2) on the right side of the rear cross, and pay attention to the pressure bar with the empty side facing upward, and then after aligning the holes, tighten the top holes using screws M4×16 (AA), and then use the bolts M6×15 (GG) to align the holes in the side of the rear crossbar, and tighten them.



F1 1x



F2 1x

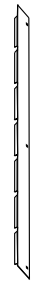

F3 1x

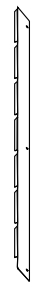

F4 1x

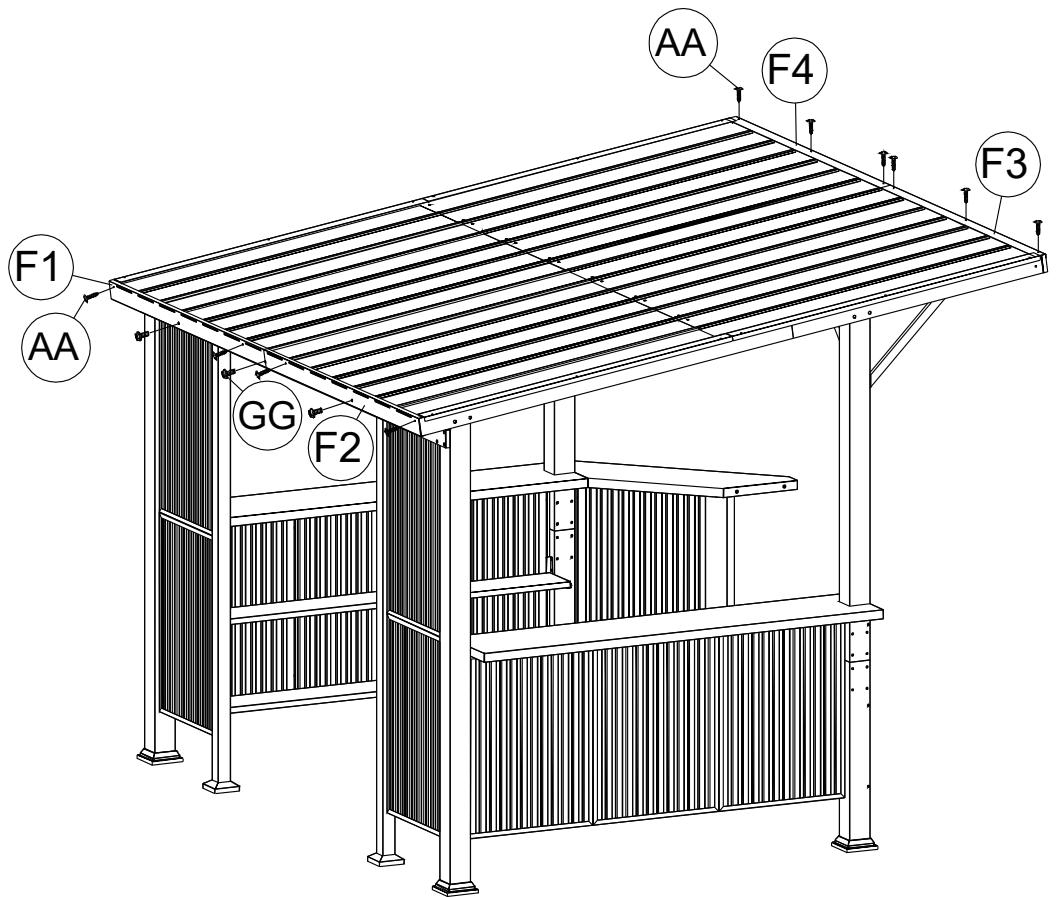

GG 3x

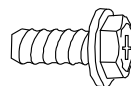

M6x15

AA 10x



M4x16

STEP 36

Secure the post to the ground with ground nails(PP) and expansion screws(UU).
NOTE:Review the pictures to determine the location of the screw holes and the orientation of the parts.

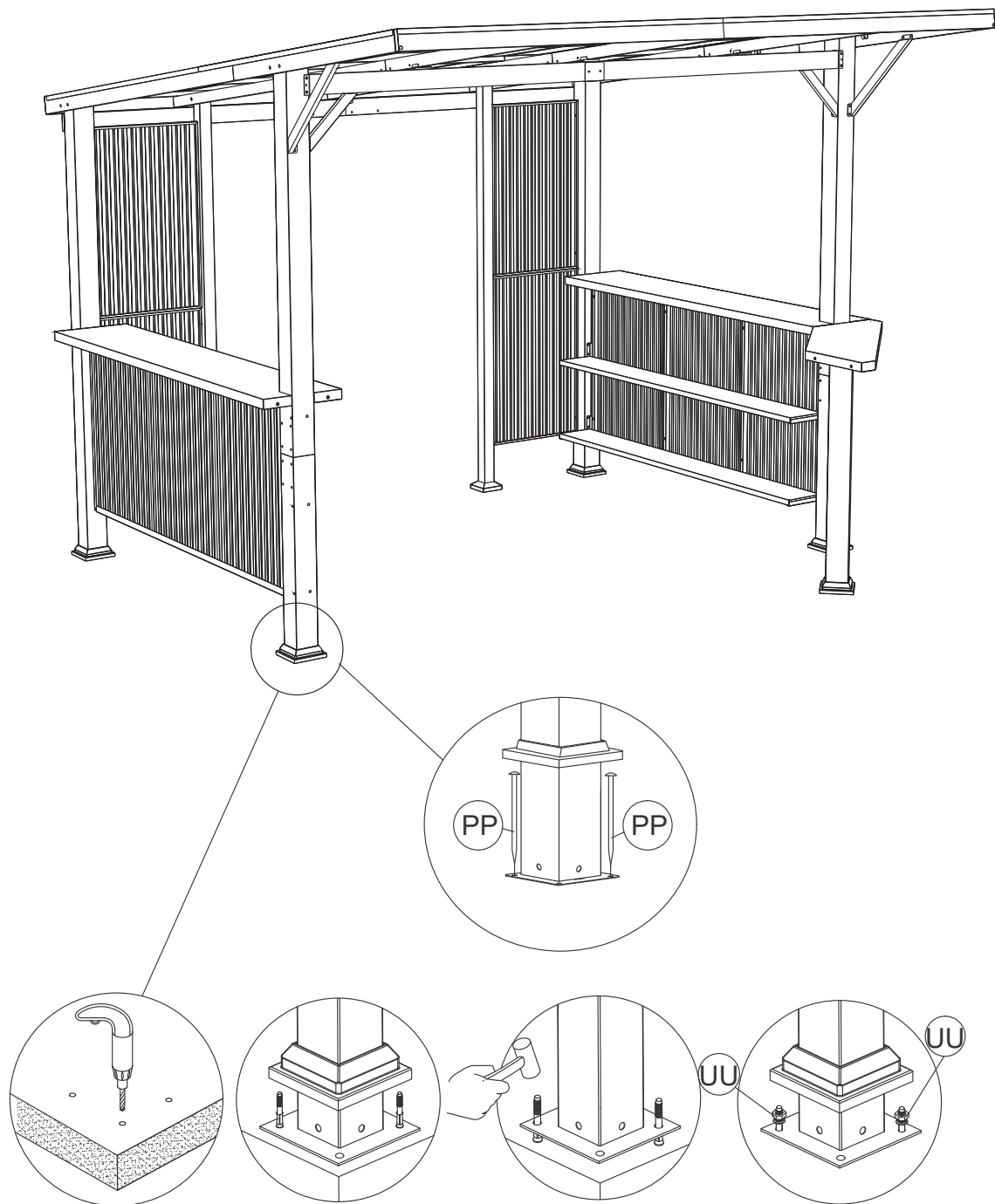

UU 8x

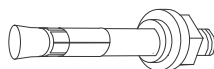

M6X80

PP 8x

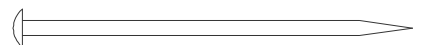

D8X180

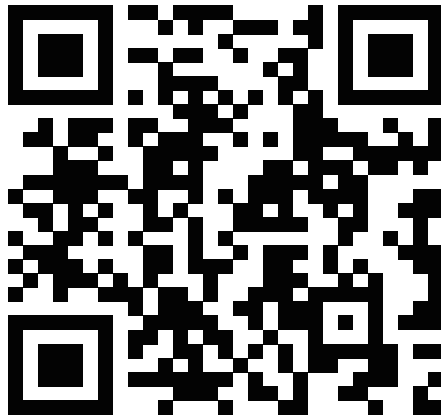

www.alaulm.com

Make your life much better.