

10 : 00

---

estimated  
installation time



1 or more

---

people required

Ok, let's  
get started!



- Put on mood music!
- To prevent damage to product, use the clean side of package carton or rug as working surface.
- In the event of missing or damaged parts, delivery problems etc., please reach out to our team. We will be happy to fix the problem!

# care guide

- Clean regularly with a soft and dry cloth.
- To protect finish, avoid use of abrasive cleaners.
- Wipe up spills immediately. Please!



product  
parts

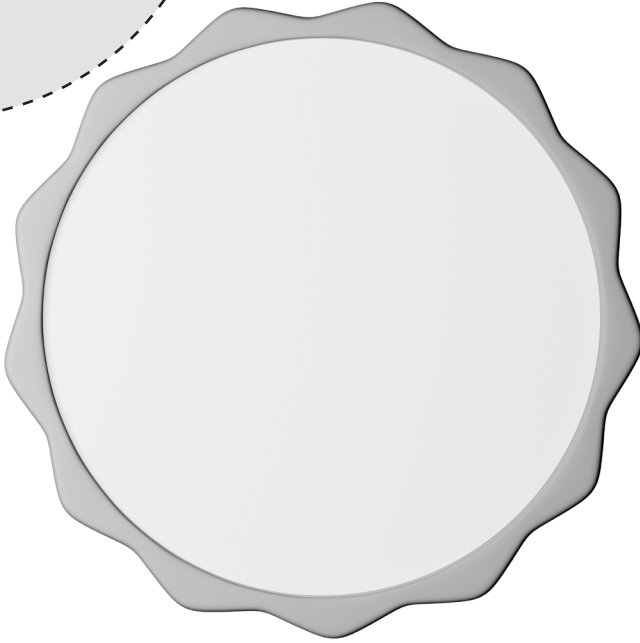

A  
Mirror  
x1



B  
French Cleat  
x1

# what's included

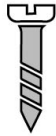

(C) - Screw  
x3



(D) - Wall Plug  
x3

## installation instructions

Take a deep breath going in.  
This is easy even if you are not  
used to tools. Just follow these  
steps to the T, and the  
outcome will be  
worth it!



## step 1:

Start by placing French cleat (B) on the wall you want to hang the mirror on and put a spirit level on it to check alignment. Adjust if needed. Once it is in a straight alignment, mark the wall through the pre-drilled holes on French cleat (B). Take this image as a reference.

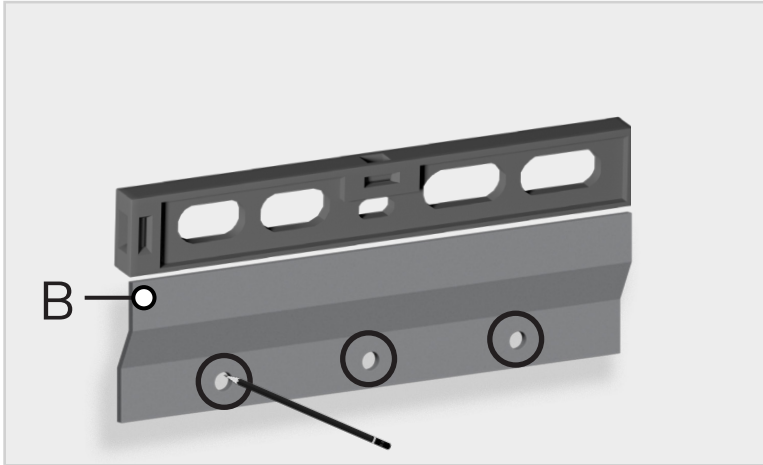

## step 2:

Drill holes approx. 10 mm at the points you just marked.



step 3:

Insert the wall plug (D) and tighten with the help of a screwdriver.

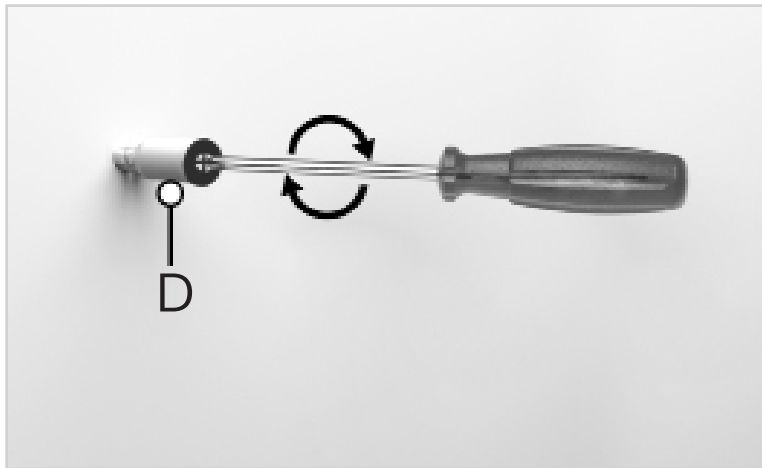

step 4:

Fix screws (C) into the wall plugs (D). Use a screwdriver to make sure they are secure.

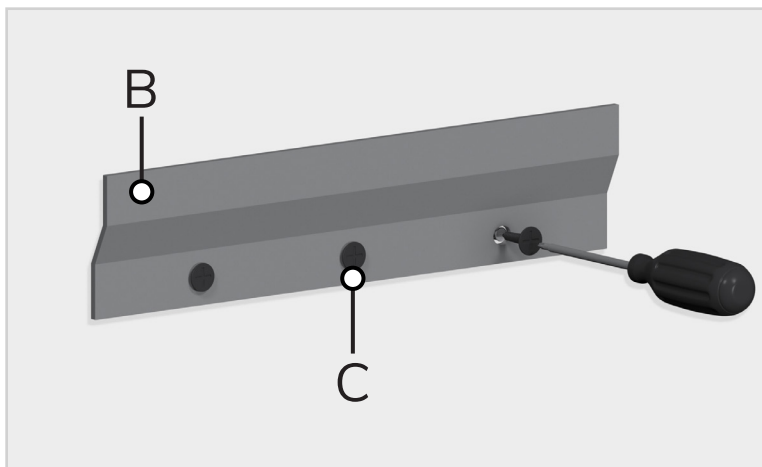

step 5:

Note the French cleat bracket prefixed on the mirror (A).

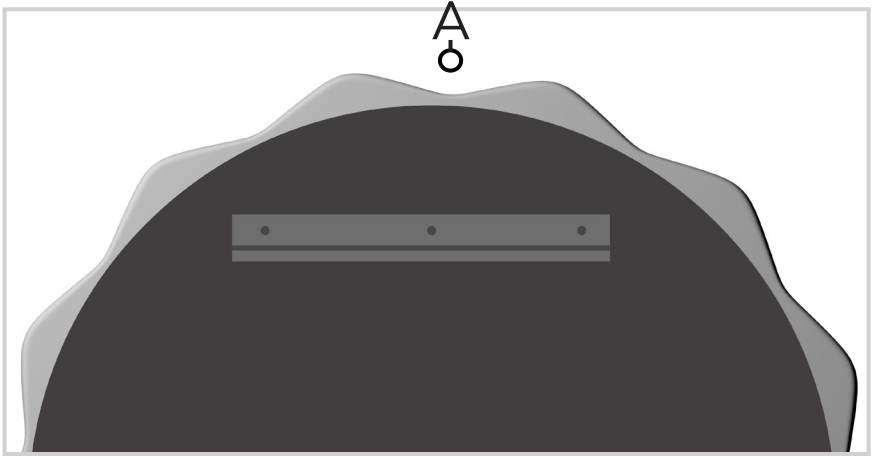

step 6:

Place the mirror's bracket into the French Cleat (B) on the wall.

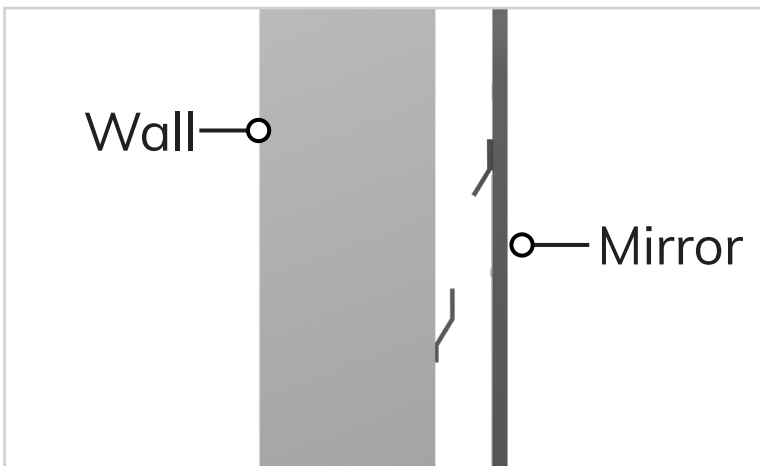

---

Voila! Your mirror is now installed and secure!