

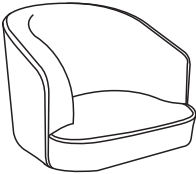
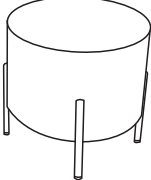

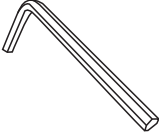
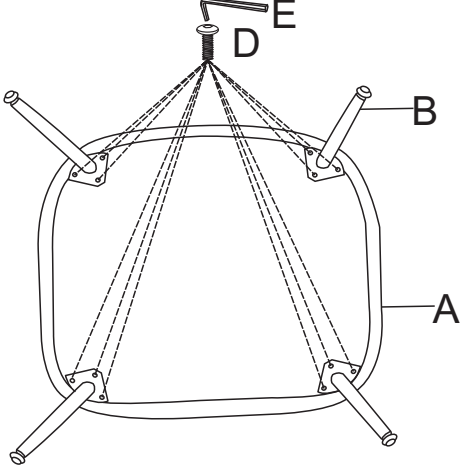
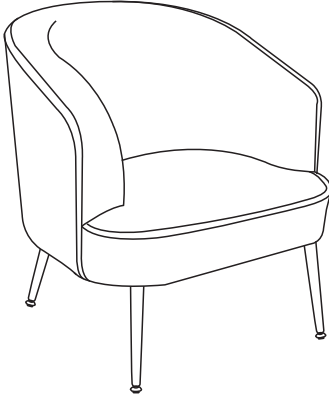
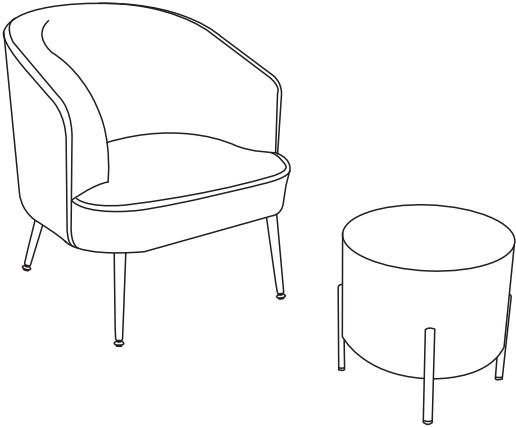

ASSEMBLY INSTRUCTIONS

 <p>Ax1</p>	 <p>Bx4</p>	 <p>Cx1</p>
 <p>Dx12</p>	 <p>Ex1</p>	
<p>1</p>		
<p>2</p>		
<p>3</p>		

Remark:After installation if there is uneven can adjust the pad to achieve balance