



**USER MANUAL
&
INSTALLATION INSTRUCTIONS
BUILT-IN OVEN 24”
5-FUNCTIONS**



IMPORTANT SAFETY INSTRUCTIONS

**Carefully read the following important information regarding
installation safety and maintenance.**

Keep these instructions for future reference.

Contents

- Safety Requirements 3
 - Proper installation and maintenance 3
 - Fire safety 4
 - Burn prevention 5
 - Child safety 6
 - Cleaning safety 6
 - Cookware safety 6
- Electrical Requirements 7
- Installation Instructions 8
 - Installation of built-in ovens 8
 - Electrical installation 10
- How To Use Your Oven 12
 - Close-up view 12
 - Before using your oven for the first time 12
 - Operating the oven 13
 - Clock functions 14
 - Timer functions 14
 - Oven functions 17
- Practical Cooking Advice 18
 - Practical cooking advice table 21
- How To Maintain Your Oven 22
 - How to remove the oven door 23
 - Replacing the oven lamp 24
- Transport 25
- Technical Specifications 25

Safety Requirements



IMPORTANT SAFETY INSTRUCTIONS



READ AND SAVE THESE INSTRUCTIONS

⚠ WARNING



When properly cared for, your new appliance has been designed to be safe and reliable. Read all instructions carefully before use.

These precautions will reduce the risk of burns, electric shock, fire and injury to persons. When using kitchen appliance, basic safety precautions must be followed, including those in the following pages.









Proper installation and maintenance

• ⚠ IMPORTANT - SAVE FOR THE LOCAL INSPECTOR'S USE

- ⚠ Have the installer show you the location of the circuit breaker or fuse. Mark it for easy reference.
- ⚠ Be sure your appliance is properly installed and grounded by a qualified technician. Connect only to a properly grounded outlet. Refer to the Installation Instructions for details.
- ⚠ This appliance is intended for normal family household use only. It is not approved for outdoor use. See the Warranty. If you have any questions, contact the manufacturer.
- ⚠ Do not store or use corrosive chemicals, vapors, flammables or nonfood products in or near this appliance. It is specifically designed for use when heating or cooking food. The use of corrosive chemicals in heating or cleaning will damage the appliance and could result in injury.
- ⚠ Do not operate this appliance if it is not working properly, or if it has been damaged. Contact an authorized servicer.
- ⚠ Do not obstruct oven vents.
- ⚠ Do not repair or replace any part of the appliance unless specifically recommended in this manual. Refer all servicing to a factory authorized service center.

-  In the event of an error the display flashes and beeps continuously. Disconnect appliance from the power supply and call a qualified technician.
-  Do not repair or replace any part of the appliance unless specifically recommended in the manual. All other servicing should be referred to a qualified technician.

Fire safety

-  Do not use aluminum foil or protective liners to line any part of the appliance, especially the oven bottom. Installing these liners may result in risk of electric shock or fire.
-  If materials inside an oven should ignite, keep door closed. Turn off the appliance and disconnect the circuit at the circuit breaker box.
-  Use this appliance only for its intended purpose as described in this manual. For example, never use the appliance for warming or heating the room. Never use the appliance for storage.
-  Always have a working smoke detector near the kitchen.
-  In the event that personal clothing or hair catches fire, drop and roll immediately to extinguish flames.
-  Smother flames from food fires other than grease fires with baking soda. Never use water on cooking fires.
-  Have an appropriate fire extinguisher available, nearby, highly visible and easily accessible near the oven.
-  Never Leave Surface Units Unattended at High Heat Settings.

⚠ WARNING

TO REDUCE THE RISK OF PERSONAL INJURY IN THE EVENT OF A GREASE FIRE, OBSERVE THE FOLLOWING:

- SMOTHER FLAMES with a close-fitting lid, cookie sheet, or metal tray, then turn off the burner. EXERCISE CAUTION TO PREVENT BURNS. If the flames do not go out immediately, EVACUATE AND CALL THE FIRE DEPARTMENT.
- NEVER PICK UP A FLAMING PAN—You may be burned.
- Do Not Use Water on Grease Fires , Smother fire or flame or use dry chemical or foam-type extinguisher.
- Use an extinguisher ONLY if:
 - 1) You know you have a CLASS ABC extinguisher, and you already know how to operate it.
 - 2) The fire is small and contained in the area where it started.
 - 3) The fire department is being called.
 - 4) You can fight the fire with your back to an exit.

Burn prevention

• ⚠ DO NOT TOUCH HEATING ELEMENTS OR INTERIOR SURFACE OF OVEN

• ⚠ Heating elements may be hot even though they are dark in color. Interior surfaces of an oven become hot enough to cause burns. During and after use, do not touch, or let clothing, potholders, or other flammable materials contact heating elements or interior surfaces of oven until they have had sufficient time to cool. Other surfaces of the appliance may become hot enough to cause burns. Among these surfaces are oven vent openings, surfaces near these openings and oven doors.

• ⚠ Exercise caution when opening the appliance. Standing to the side, open the door slowly and slightly to let hot air and/or steam escape. Keep your face clear of the opening and make sure there are no children or pets near the unit. After the release of hot air and/or steam, proceed with your cooking. Keep doors

shut unless necessary for cooking or cleaning purposes. Do not leave open doors unattended.





• ⚠ Do not heat or warm unopened food containers. Build-up of pressure may cause the container to burst and cause injury.

• ⚠ Always place oven racks in desired location while oven is cool. If a rack must be moved while oven is hot, do not let potholder contact the heating elements.



• ⚠ Always use dry potholders. Moist or damp potholders on hot surfaces may result in burns from steam. Do not let potholder touch hot heating elements. Do not use a towel or other bulky cloth.

• ⚠ Secure all loose garments, etc. before beginning. Tie long hair so that it does not hang loose, and do not wear loose fitting clothing or hanging garments, such as ties, scarves, jewelry, or dangling sleeves.





Child safety

-  Secure all loose garments, etc. before beginning. Tie long hair so that it does not hang loose, and do not wear loose fitting clothing or hanging garments, such as ties, scarves, jewelry, or dangling sleeves.
-  When children become old enough to use the appliance, it is the legal responsibility of the parents or legal guardians to ensure that they are instructed in safe operation of the appliance by qualified persons.
-  Do not allow anyone to climb, stand, lean, sit, or hang on any part of an appliance, especially a door, warming drawer or storage drawer. This can damage the appliance, and the unit may tip over, potentially causing severe injury.
-  Do not allow children to use this appliance unless closely supervised by an adult. Children and pets should not be left alone or unattended in the area where the appliance is in use. They should never be allowed to play in its vicinity, whether or not the appliance is in use.
-  Items of interest to children should not be stored in an appliance, in cabinets above an appliance or on the backsplash. Children climbing on an appliance to reach items could be seriously injured.

Cleaning safety

-  **CAUTION:** Do not clean the appliance while it is still hot. Some cleaners produce noxious fumes when applied to a hot surface. Wet clothes or sponges can cause burns from steam.
-  Do Not Use Oven Cleaners – No commercial oven cleaner or oven liner protective coating of any kind should be used in or around any part of the oven.

Cookware safety

-  Birds have very sensitive respiratory systems. Keep pet birds out of the kitchen or other rooms where kitchen fumes could reach them. During self-clean, fumes are released that may be harmful to birds. Other kitchen fumes such as overheating margarines and cooking oils may also be harmful.
-  Keep oven free from grease build up.
-  Do not place food directly on oven bottom.
-  Follow the manufacturer's directions when using cooking or roasting bags.

Electrical Requirements

⚠ WARNING



Electrical Shock Hazard

Do not use an extension cord.

Failure to follow these instructions can result in death, fire, or electrical shock.

- **⚠** Any additions, changes or conversions required in order for this appliance to satisfactorily meet the application needs must be made by a qualified service technician in accordance with the manufacturer's instructions and all codes and requirements of the authority having jurisdiction. Failure to follow the instructions could result in serious injury or property damage. The qualified agency performing this work assumes responsibility for the conversion.
- **⚠** This appliance needs to be installed directly to the main (without a plug). To do so, follow instructions in the "Electrical Connection" section. If you wish to install this appliance directly to the main (without a plug), it must be installed by a qualified service technician.
- **⚠ DO NOT** operate this appliance using a 2-prong adapter or an extension cord. If a 2-prong wall receptacle is the only available outlet, it is the personal responsibility of the consumer to have it replaced with a properly grounded 4-prong wall receptacle installed by a qualified electrician.
- **⚠** Severe shock, or damage to the range may occur if the range is not installed by a qualified installer or electrician.
- **⚠** This appliance features a pilotless electric ignition for energy savings and reliability. It operates on a **208-240V/50-60Hz 12-15 Amp** power supply.
- **⚠** A separate circuit, protected by a 15 amp time delay fuse or circuit breaker, is required.
- **⚠** For personal safety, the appliance must be properly grounded.
- **⚠** See the "Installation Instructions" for complete installation and grounding instructions.

Installation Instructions

⚠ WARNING



Electrical Shock Hazard

Do not use an extension cord.

Failure to follow these instructions can result in death, fire, or electrical shock

Only a qualified person in compliance with the instructions provided must install the appliance. The manufacturer declines all responsibility for improper installation, which may harm persons and animals and damage property.

Important:

- The power supply to the appliance must be cut off before any adjustments or maintenance work is done on it.
- Air duct is supposed to use in ventilation.

Installation of built-in ovens

In order to ensure that the built-in appliance functions properly, the cabinet containing it must be appropriate. The figure below gives the dimensions of the cut-out for installation under the counter or in a wall cabinet unit. (See Figure 1)

Oven door structures 2 or 3

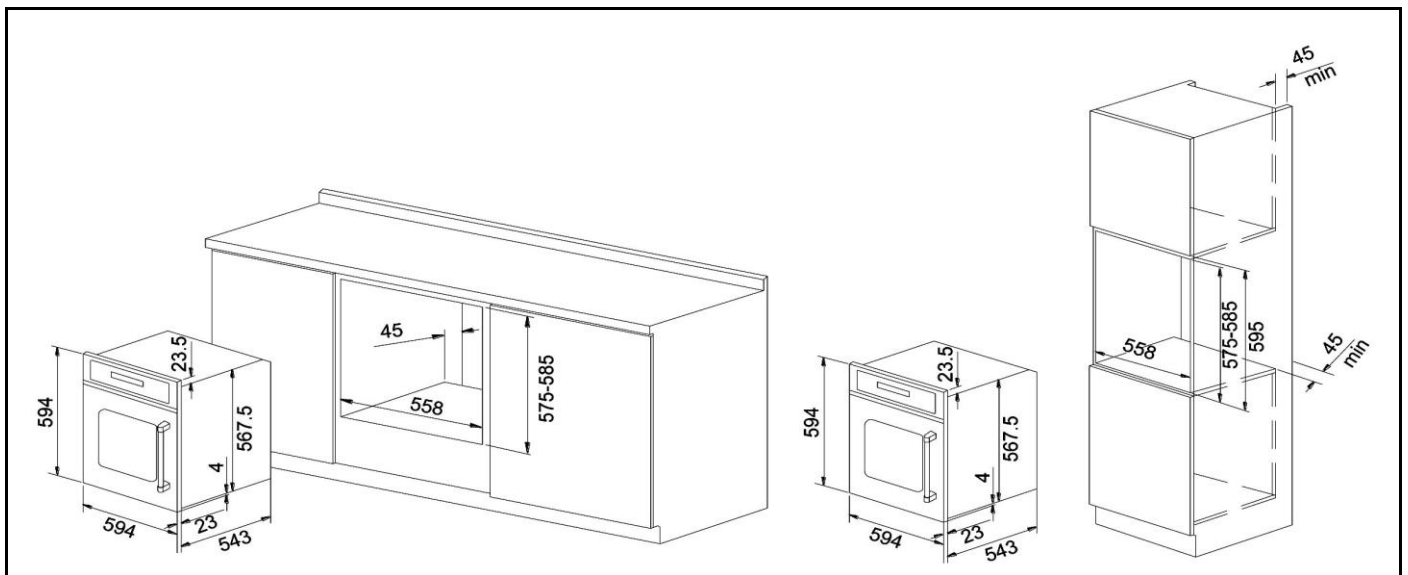

Figure 1

IMPORTANT:

Installation must be in compliance with the consumption declaration.

In order to ensure adequate ventilation, the back panel of the cabinet unit must be removed. Installing the oven so that it rests on two strips of wood is preferable. If the oven rests on a continuous, flat surface, there must be an aperture of at least 1 3/4" x 22" (45 x 560mm). (See Figure 2)

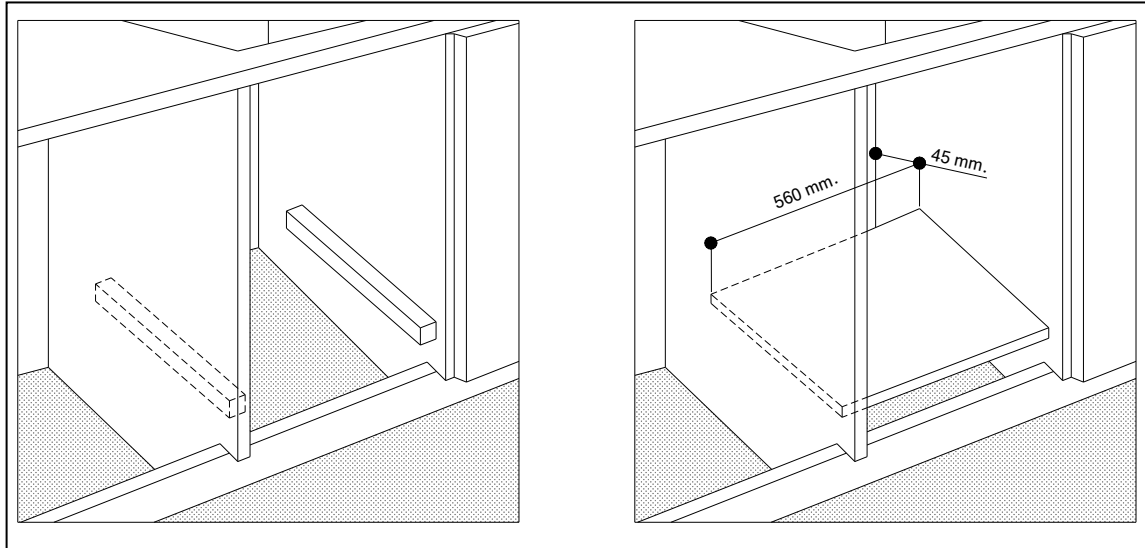

Figure 2

The panels of the adjacent cabinets must be made of heat-resistant material. In particular, cabinets with a veneer exterior must be assembled with glues which can withstand temperatures of up to 100 degrees Celsius.

In compliance with current safety standards, contact with the electrical parts of the oven must not be possible once it has been installed.

All parts, which ensure the safe operation of the appliance, must be removable only with the aid of a tool.

To fasten the oven to the cabinet, open the door of the oven and attach it by inserting the 4 wooden screws into the 4 holes located on the perimeter of the frame.

Electrical installation

⚠ WARNING



Electrical Shock Hazard

Do not use an extension cord.

Failure to follow these instructions can result in death, fire, or electrical shock

Only a qualified person in compliance with the instructions provided must install the appliance. The manufacturer declines all responsibility for improper installation, which may harm persons and animals and damage property.

Important:

- The power supply to the appliance must be cut off before any adjustments or maintenance work is done on it.
- Air duct is supposed to use in ventilation.

IMPORTANT:

Local Codes may vary; installation, electrical connections and grounding must comply with all applicable local codes.

If local codes permit grounding through the electrical supply neutral, connect both the white neutral wire and the bare ground wire from the oven to the white neutral electrical supply wire.

All model ovens on the front cover are dual rated, designed to be connected to either 208/240V AC, 60Hz, 3 wire, two-phase power supply. (See Figure 3)

CIRCUIT REQUIRED	
208V,60Hz	240V,60Hz
12 AMP	15 AMP

Figure 3

The electrical supply should be 3-wire two-phase AC. Install a suitable conduit box (not furnished). An appropriately-sized, U-listed conduit connector must be used to correctly attach the conduit to the junction box.

Three-Wire Connection

- Connect red wire from oven to red wire in junction box.
- Connect black wire from oven to black wire in junction box.
- Connect green ground wire from oven to gray neutral wire in junction box.

The conduit cable, where connected at the oven, swivels. Rotate conduit cable upward (or downward) and direct through hole prepared in cabinet to attach to J-Box.

To maintain serviceability, the flex conduit must not be shortened and should be routed to permit temporary removal of the oven. (See Figure 4)

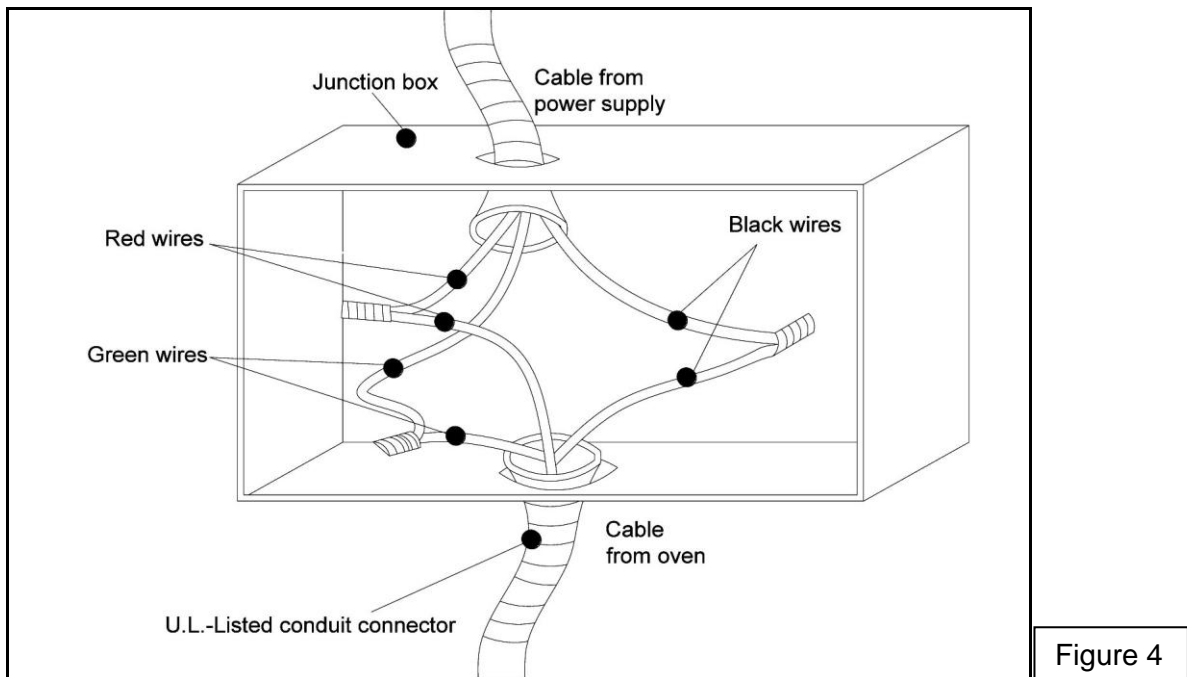

How To Use Your Oven

Close-up view

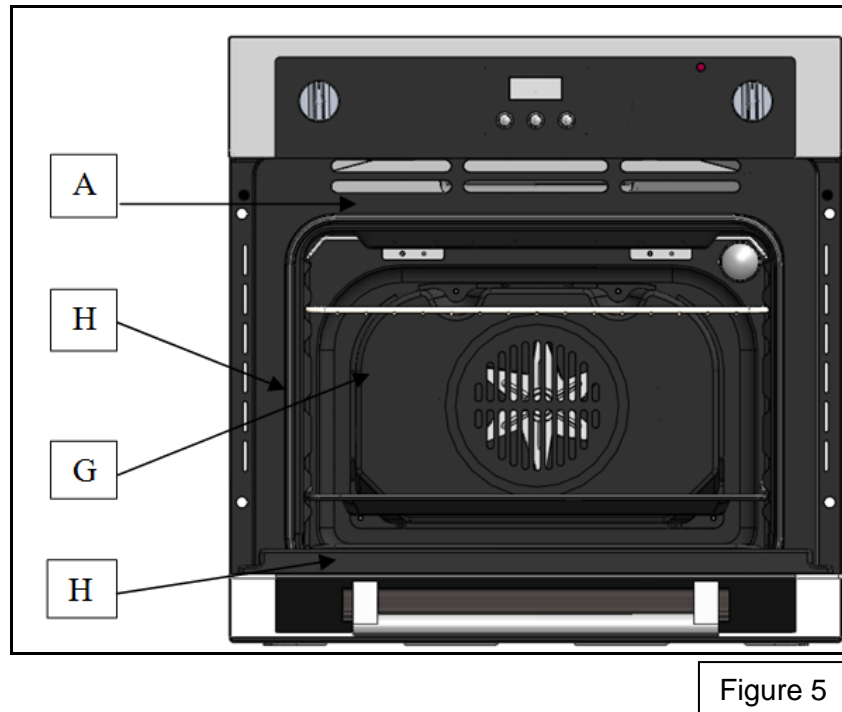

A. Control panel

G. Oven rack

H. Guides for sliding the racks or dripping in and out

Before using your oven for the first time

This multi-function oven combines the advantages of traditional convection ovens with those of the more modern fan assisted models in a single appliance.

It is an extremely versatile appliance that allows you to choose easily and safely between different cooking modes.

IMPORTANT:

The first time you use your appliance, we recommend that set the thermostat to the highest setting and leave the oven on for about half an hour with nothing in it, with the oven door shut. Then open the oven door and let the room air in. The odor that is often detected during this initial use is due to the evaporation of substances used to protect the oven during storage and until it is installed.

IMPORTANT:

Place the dripping pan provided (only available on certain models) on the bottom shelf of the oven to prevent any sauce and/or grease from dripping onto the bottom of the oven only when grilling food or when using the rotisserie (only available on certain models).

For all other types of cooking, never use the bottom shelf and never place anything on the bottom of the oven when it is in operation because this could damage the enamel.

Always place your cookware (dishes, aluminum foil, etc.) on the grid provided with the appliance inserted especially along the oven guides.

Operating the oven

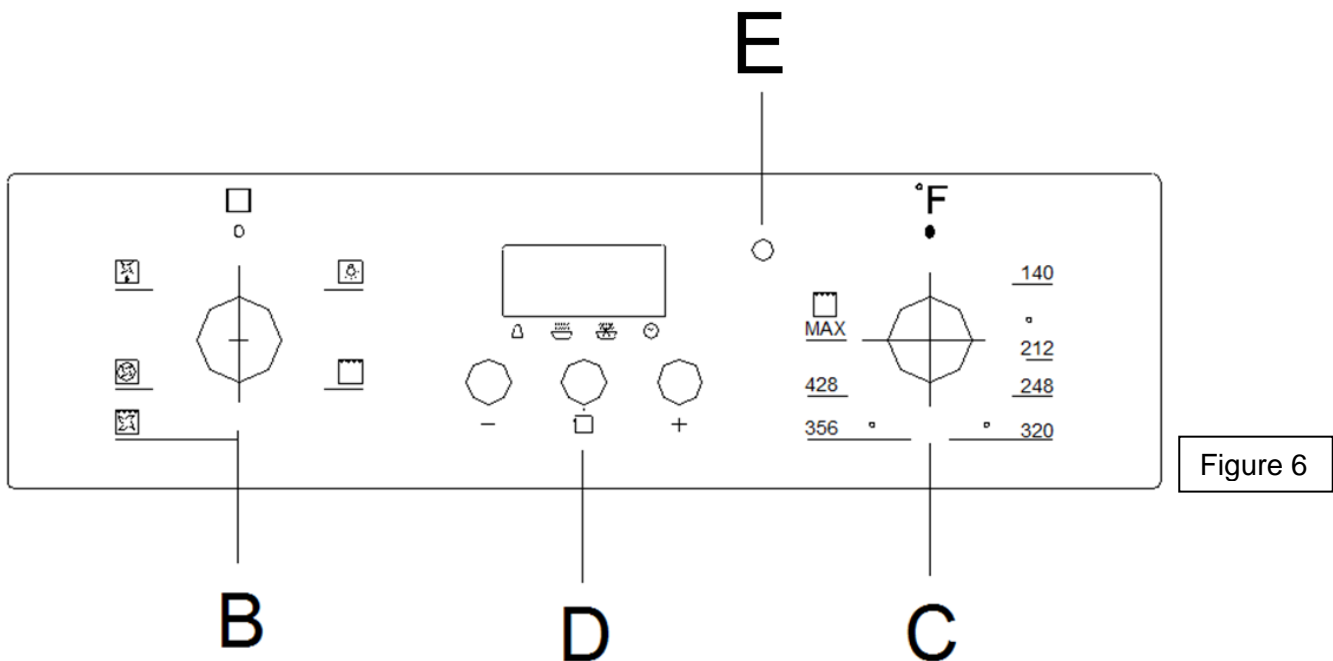

Figure 6

It is an extremely versatile appliance that allows you to choose easily and safely between different cooking modes.

- B. Cooking mode selection knob**
- C. Cooking temperature selection knob**
- D. Function button to select cooking time and set timer**
- E. Oven indicator light (only available on certain models)**

Push-in control knob (only available on certain models)

Control knob can be pushed in, and you can push the control knob lightly to release it or lock it.

IMPORTANT: To use the oven in manual mode (not using the end cooking time programmer); the symbol must be aligned with the reference mark on the control panel.

Clock functions

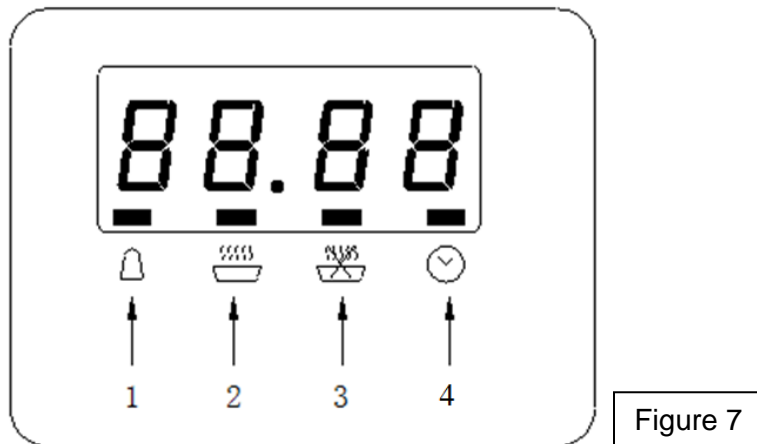

- Once the oven is connected to electrical power, the clock display will show “12:00” with the square symbol above “” (See Figure 7)
- Press the “+” or “-” button will increase or decrease the number until it reaches the right time
- After 5 seconds the clock will start automatically or you can press the function button to make it work.

Timer functions



1. **Timer**
2. **Start cooking time set**
3. **End cooking time set**
4. **Clock**





Timer

- The longest cooking time that can be set is 23 hours and 59 minutes.
- For setting time:
 1. Press the function button repeatedly until the square symbol above “” flashes,
 2. Press “+” or “-” button until the time you wish shows on the display.
 3. After setting, the proper time (hour./minute), the square symbol above the “” begins to flash.
 4. The time countdown begins.
- When it reaches the set time, the square symbol above the “” flashes, and the alarm will ring.
- To stop the ringing press any button.

IMPORTANT:



- The setting must be carried out in 5 seconds.
- If electricity fails suddenly, all the set procedure and the proper clock time (hour, minute) will disappear.
- After electrical power is on again, "12:00" and the square symbol above "  " will show on the display, you will need to set it again.

Full Automatic Timer Setting (Set the time for full automatic starting and finishing)

1. Press the function button (See Figure 6) repeatedly until the square symbol above the "  " flashes, and press " **+** " or " **-** " button to set how long oven needs to cook.
2. Press the function button repeatedly until the square symbol above the "  " flashes, and press " **+** " or " **-** " button to set the time for oven to stop cooking and switch off.
3. Adjust Knob B and C (See Figure 6) to select cooking mode and temperature mode.
4. The symbols above the "  " and "  " will flash, it indicates the cooking timer has been set. The cooking will start and finish as per programmed into the timer.



For example:

If the food is required to bake for 45 minutes, and it is supposed to stop at 14:00



- Press the function button repeatedly until the square symbol above "  " flashes, and set the time of baking to 45 minutes.
- Press the function button repeatedly until the square symbol above "  " flashed, and set the finish of baking at 14:00.
- The proper clock (hour/ minute) and the square symbol will show on the display, it indicates the setting of cooking timer has been remembered automatically.
- When the clock shows 13:15, the oven will switch on automatically and cooking will start.
- During the cooking time, the square symbol will keep flashing.
- When the clock shows 14:00, cooking will stop and the oven will switch off automatically, the alarm will ring, and the square symbol will flash.
- To stop the ringing press any button.

Semi-Automatic Timer Setting

A. Setting timer for how long to cook

1. Longest time that can be set is 10 hours maximum.
2. Press the function button (See Figure 6) repeatedly until the square symbol above “” is flashing, press “+” or “-” button and set the timer for how long the oven needs to cook.
3. Switch on the oven immediately, the square symbol above “” begins to flash.
4. Adjust Knob B and C (See Figure 6) to select cooking mode and temperature mode.
5. When the full amount of time set has passed, the cooking will stop and the oven will switch off automatically.
6. The square symbol above “” will flash and the alarm will ring.
7. To stop the ringing press any button.

B. Setting timer with the end time of cooking

1. Longest time that can be set is 23 hours and 59 minutes.
2. Press the function button (See Figure 6) repeatedly until the square symbol above “” flashes, press “+” or “-” button and set the time for oven to stop cooking.
3. Switch on the oven immediately, the square symbol above “” begins to flash.
4. Adjust Knob B and C (See Figure 6) to select cooking mode and temperature mode.
5. When it reaches the time set, cooking will stop and the oven will switch off automatically.
6. The square symbol above “” flashes, and the alarm will ring.
7. To stop the ringing press any button.

IMPORTANT:

The set timer procedure could be seen by pressing any function button repeatedly at any time. By adjusting the end time of cooking to the current time, the set timer procedure can be cancelled.

Oven functions

Grill 2131W

- **Position Knob C to MAX.** (See Figure 6)
- **Cook food in the ‘Grill Mode’ with the oven door ajar.**
- The top central heating elements come on.
- The extremely high and direct temperature of the grill makes it possible to brown the surface of meats and roasts while locking the juices in to keep them tender.
- The grill is also highly recommended for dishes that require a high temperature on the surface like beef steaks, veal, rib steak, filets, hamburgers.
- Some grilling examples are included in the “Practical Cooking Advice Table” on Page 21.

Fan Assisted Grill 2161W

- **Position Knob C between 60°C and 200°C.** (See Figure 6)
- **Cook food in “Fan Assisted Grill Mode” with the oven door shut.**
- The top central heating elements and the fan come on.
- This combination of features increases the effectiveness of the unidirectional thermal radiation of the heating elements through forced circulation of the air throughout the oven.
- This helps prevent food from burning on the surface, allowing the heat to penetrate right into the food.
- Excellent results are achieved with kebabs made with meats and vegetables, sausages, ribs lamb chops, chicken in a spicy sauce, quail, and pork chops.
- This mode is also ideal for cooking fish steaks, like swordfish, stuffed cuttlefish.

Baking Mode 2015W

- **Position Knob C between 60°C and 250°C.** (See Figure 6)
- The rear heating element and the fan come on, guaranteeing delicate heat distributed uniformly throughout the oven.
- This mode is ideal for baking and cooking delicate foods, especially cakes that need to rise- and for the preparation of certain tartlets on 3 shelves at the same time.
- Here are a few examples: cream puffs, sweet and savory biscuits, savory puffs, Swiss rolls and small portions of vegetables au gratin.

Defrosting Mode 55W

- **Position Knob C to any temperature.** (See Figure 6)
- The fan located on the bottom of the oven makes the air circulate at room temperature around the food.

- This is recommended for the defrosting of all types of food, but in particular for delicate types of food which do not require heat, such as ice cream cakes, cream or custard desserts, and fruitcakes.
- By using the fan, the defrosting time is approximately halved. In the case of meat, fish and bread, it is possible to accelerate the process using the “**Baking Mode**” and setting the temperature to 80°C-100°C.

Turnspit (only available on certain models)

To start the turnspit, proceed as follows:

1. **Position Knob B to select**  . (See Figure 6)
2. Place the oven tray on the 1st rack
3. Insert the special turnspit support on the 2nd rack and position the spit by inserting it through the special hole into the turnspit at the back of the oven

Cooling Ventilation

- In order to cool down the exterior of the appliance, this model is equipped with a cooling fan, which comes on automatically when the oven is hot.
- When the fan is on, a normal flow of air can be heard exiting between the oven door and the control panel.
- **Note: When cooking is done, the fan stays on until the oven cools down sufficiently.**

Oven Light

1. **Position Knob B to select**  (See Figure 6)
2. It lights the oven and stays on when any of the electrical heating elements in the oven come on.

Practical Cooking Advice

The oven offers a wide range of alternatives which allow you to cook any type of food in the best possible way. With time you will learn to make the best use of this versatile cooking appliance and the following directions are only a guideline which may be varied according to your own personal experience.

Cooking on more than one rack

- If you have to cook food using several racks, use the “**Baking Mode**”.
- When cooking delicate food on more than one rack, use the “**Baking Mode**”, which allows you to cook on three (3) racks at the same time (the 1st, 3rd, and 5th from the bottom). Some examples are included in the “Practical Cooking Advice Table” on Page 21.
- When cooking other food on several racks, keep the following suggestions in mind:

- The oven is fitted with 5 racks. During fan assisted cooking, use two of the three central racks; the lowest and highest racks receive the hot air directly and therefore delicate foodstuffs could be burnt on these racks.
- As a general rule, use the 2nd and 4th rack from the bottom, placing the foodstuffs that require greater heat on the 2nd rack from the bottom. For example, when cooking meat roasts together with other food, place the roast on the 2nd rack from the bottom and the more delicate food on the 4th rack from the bottom.
- When cooking foodstuffs that require differing times and temperatures, set a temperature that is somewhere between the two temperatures required, place the more delicate food on the 4th rack from the bottom and take the food requiring less time out of the oven first.
- Use the dripping pan on the lower rack and the grid on the upper rack.

Using the grill

- This multi-function oven offers you 2 different grilling modes.

Use the “grill” mode with the oven door ajar

1. Placing the food under the center of the grill (situated on the 3rd or 4th rack from the bottom) because only the central part of the top heating element is turned on.
2. Use the bottom rack (1st from the bottom), placing the dripping pan provided to collect any sauce and /or grease and prevent the same from dripping onto the oven bottom.
3. When using this mode, we recommend you set the thermostat to the highest setting. However, this does not mean you cannot use lower temperatures, simply by adjusting the thermostat knob to the desired temperature.

Use the “fan assisted grill” , ONLY with the oven door shut

1. It is extremely useful for grilling foods rapidly, as the distribution of heat makes it possible not only to brown the surface, but also to cook the bottom part.
 2. Moreover, it can also be used for browning foods at the end of the cooking process, such as adding that gratin finish to pasta bakes.
 3. When using this mode, place the grid on the 2nd or 3rd oven rack from the bottom. (See “Practical Cooking Advice Table” on Page 21). To prevent fat and grease from dripping onto the bottom of the oven and thus smoke from forming, place a dripping-pan on the 1st rack from the bottom.
- **Important: Always use the “fan assisted grill” with the oven door shut.** This will allow you to obtain excellent results and to save on energy.
 - When using this mode, we advise you to set the thermostat to 200°C, as it is the most efficient way to use the grill, which is based on the use of infrared rays. However, this does not mean you cannot use lower temperatures, simply by adjusting the thermostat knob to the desired temperature.

- **Therefore the best results when using the grill modes are obtained by placing the grid on the lower racks** (See “Practical Cooking Advice Table” on Page 21), **then, to prevent fat and grease from dripping onto the bottom of the oven and smoke from forming, place a dripping-pan on the 1st oven rack from the bottom.**

Baking cakes

- When baking cakes, always place them in a preheated oven.
- Make sure you wait until the oven has been preheated thoroughly. The oven indicator light will turn off. (See Figure 6)
- Do not open the oven door during baking to prevent the cake from dropping.

In general if:

Pastry is too dry

Increase the temperature by 10°C and reduce the cooking time.

Pastry dropped

Use less liquid or lower the temperature by 10°C.

Pastry is too dark on top

Place it on a lower rack, lower the temperature, and increase the cooking time.

Cooked well on the inside but sticky on the outside

Use less liquid, lower the temperature, and increase the cooking time.

The pastry sticks to the pan

Grease the pan well and sprinkle it with a dusting of flour or use greaseproof paper.





I used more than one level (in the function “ventilated oven”) and they are not all at the same cooking point

Use a lower temperature setting. It is not necessary to remove the food from all the racks at the same time.

Cooking fish and meat

- When cooking white meat, fowl and fish, use temperature setting from 180°C to 200°C.
- For red meat that should be well done on the outside while tender and juicy in the inside, it is a good idea to start with a high temperature setting (200°C to 220°C) for a short time, then turn the oven down afterwards.
- In general, the larger the roast, the lower the temperature setting. Place the meat on the center of the grid and place the dripping pan beneath it to catch the fat. Make sure that the grid is inserted so that it is in the center of the oven.
- If you would like to increase the amount of heat from below, use the low rack heights. For savory roasts (especially duck and wild game), dress the meat with lard or bacon on the top.

Practical cooking advice table

Selector knob setting	Food to be cooked	Weight (in kg)	Cooking rack position from bottom	Preheating time (Minutes)	Thermostat knob setting	Cooking time (Minutes)
1. Defrosting 	All frozen food					
2. Grill 	Soles and cuttlefish	1	4	5	Max	8-10
	Squid and prawn kebabs	1	4	5	Max	6-8
	Cod filet	1	4	5	Max	10
	Grilled vegetables	1	3/4	5	Max	10-15
	Veal steal	1	4	5	Max	15-20
	Cutlets	1	4	5	Max	15-20
	Hamburgers	1	4	5	Max	7-10
	Mackerels	1	4	5	Max	15-20
	Toasted sandwiches	-	4	5	Max	2-3
	With rotisserie (where prevent)	1.0	-	5	Max	80-90
Veal on the spit	1.5	-	5	Max	70-80	
Chicken on the spit	1.0	-	5	Max	70-80	
Lamb on the spit						
3. Fan Assisted Grill 	Grilled chicken	1.5	3	5	200	55-60
	Cuttlefish	1.5	3	5	200	30-35
	With rotisserie (where prevent)	1.5	-	5	200	70-80
	Veal on the spit	2.0	-	5	200	70-80
	Chicken on the spit	1.5	-	5	200	70-75
	Chicken (on the spit)+potatoes (roasted)	-	2	5	200	70-75
	Lamb on the spit	1.5	-	5	200	70-80
4. Baking 	Tarts	0.5	3	15	180	20-30
	Fruit cakes	1	2/3	15	180	40-45
	Fruitcake	0.7	3	15	180	40-50
	Sponge cake	0.5	3	15	160	25-30
	Stuffed pancakes) on 2 racks)	1.2	2-4	15	200	30-35
	Small cakes (On 2 racks)	0.6	2-4	15	190	20-25
	Cheese puffs (on 2 racks)	0.4	2-4	15	210	15-20
	Cream puffs (on 3 racks)	0.7	1-3-5	15	180	20-25
	Biscuits (On 3 racks)	0.7	1-3-5	15	180	20-25
	Meringues (On 3 racks)	0.5	1-3-5	15	90	180

NOTE: Cooking times are approximate and may vary according to personal taste. When cooking using the grill or fan assisted grill, the dripping pan must always be placed on the 1st oven rack from the bottom.

How To Maintain Your Oven

⚠ WARNING



Electrical Shock Hazard

Failure to follow these instructions can result in death, fire, or electrical shock.

Before cleaning your oven, or performing maintenance, disconnect it from the power supply.

To extend the life of your oven, it must be cleaned frequently, keeping in mind that:

- The enameled or stainless steel parts should be washed with lukewarm water without using any abrasive powders or corrosive substances which could ruin them
- Stainless steel could get stained. If these stains are difficult to remove, use special products available on the market. After cleaning, it is advisable to rinse thoroughly and dry.
- The inside of the oven should preferably be cleaned immediately after use, when it is still warm, with hot water and soap.
- The soap should be rinsed away and the interior dried thoroughly. Avoid using abrasive detergents (for example cleaning powders, etc) and abrasive sponges for dishes or acids (such as lime scale – remover, etc) as these could damage the enamel.
- If the grease spots and dirt are particularly tough to remove, use a special product for oven cleaning, following the instructions provided on the packet. Never use a steam cleaner for cleaning inside of oven.
- If you use your oven for an extended period of time, condensation may form. Dry it using a soft cloth.
- There is a rubber seal surrounding the oven opening which guarantees its perfect functioning. Check the condition of this seal on a regular basis. If necessary, clean it and avoid using abrasive products or objects to do so. Should it become damaged, please contact the vendor. We recommend you avoid using the oven until it has been repaired.
- Never line the oven bottom with aluminum foil, as the consequent accumulation of heat could compromise the cooking and even damage the enamel.
- Clean the glass door using non-abrasive products or sponges and dry it with a soft cloth.

How to remove the oven door

For ease of installation, some oven doors may be removed to reduce the weight of the oven by 30 lbs (14kg) per door, before installing into the cabinet.

⚠ WARNING

When removing the door:

- Make sure oven is cool and power to the oven has been turned off before removing the door. Failure to do so could result in electrical shock or burns.
- The oven door is heavy and fragile. Use both hands to remove the oven door. The door front is glass. Handle carefully to avoid breaking.
- Grasp only the sides of the oven door. Do not grasp the handle as it may swing in your hand and cause damage or injury.
- Failure to grasp the oven door firmly and properly could result in personal injury or product damage.
- To avoid injury from hinge bracket snapping closed, be sure that both levers are securely in place before removing the door. Also, do not force door open or closed - the hinge could be damaged and injury could result.

Removing oven door to clean

- For a more thorough clean, you can remove the oven door.
- The glass panels on the door can be removed to assist in cleaning.

Proceed as follows:

1. Open the door fully (See Figure 8)
2. Lift up and turn the small levers situated on the two hinges (See Figure 9)
3. Grip the door on the two external sides, shut it slowly but not completely (See Figure 10)
4. Pull the door towards you, pulling it out of its seat (See Figure 10)
5. Reassemble the door by following the above procedures backwards.

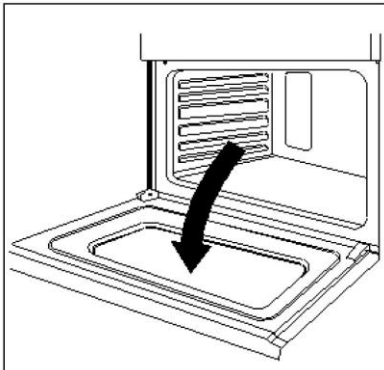

Figure 8

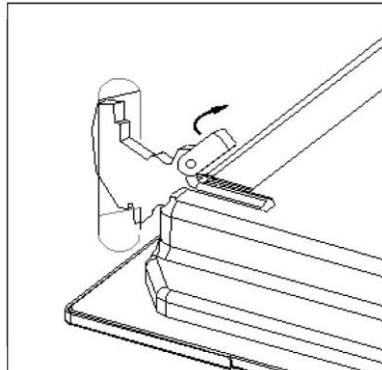

Figure 9

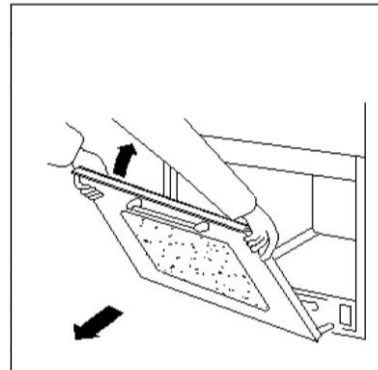

Figure 10

Replacing the oven lamp

⚠ WARNING



Electrical Shock Hazard

Failure to follow these instructions can result in death, fire, or electrical shock.

1. Disconnect the oven from the power supply by means of the omni-polar switch used to connect the appliance to the electrical mains, or unplug the appliance if the plug is accessible.
2. Remove the glass cover of the lamp-holder, turning counter-clockwise. (See Figure 11)
3. Remove the lamp and replace with a lamp resistant to high temperatures (300°C) with the following characteristics:
 - Voltage: 208-240V
 - Wattage: 25W
 - Type: E 14
4. Replace the glass cover and reconnect the oven to the mains power supply.

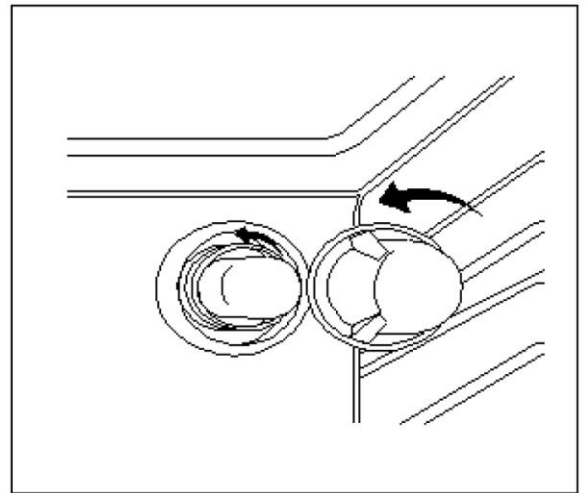

Figure 11

Transport

⚠ WARNING



Electrical Shock Hazard

Failure to follow these instructions can result in death, fire, or electrical shock.

Before moving your oven, or performing maintenance, disconnect it from the power supply.

To avoid damage to the oven vent, use the transport method shown in Figure 12.

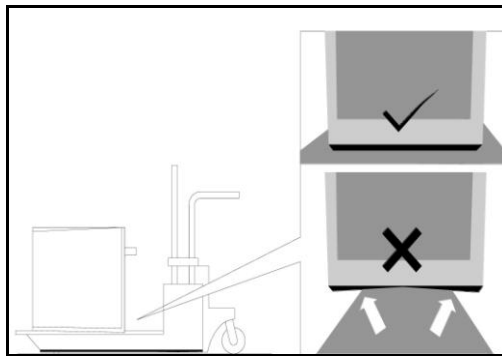

Figure 12

Technical Specifications

Model	· 51EIX
Power Source	· 240V /60Hz
Volume (usable capacity)	· 56 L
Output Power	· 2300 W
Weight	
· Net	· 71.65 lbs approx
· Weight - Shipping	· 81.6 lbs approx
Dimensions (W x H x D)	
· Outside	· 23.4 x 21.4 x 23.4 in
· Cutout	· 22 x 22.9 x 22 in
Brand Name	· Cosmo