

Manual Book

Retractable Ceiling Fans



Safety Rules

1. The input wattage for this fan should be 110V/60HZ.
2. Be sure the power to the wires you are working on is disconnected, either the fuse is removed or the circuit breaker is sure of Turning the power off use vr switch to verify electrical disconnected to prevent electric shock.
3. Aqualified licensed electrician is required for the installation.
4. The outlet box and support structure must be securely mounted and capable of reliably /supporting a minimum of 50 pounds. Use only UL (cUL for Canadian Installation) fisted mounting boxes marked "FOR FAN SUPPORT".
5. The fan must be mounted with a minimum of 7 feet clearance from the trailing edge of the blades to the floor.
6. Do not operate reversing switch while fan blades are in motion (if applicable). Fan must be tured off and blades stopped before reversing blade direction.
7. Do not place any objects in the path of the blades.
8. To avoid personal injury or damage to the fan and other items, be cautious when working around or deaning the fan.
9. Do not use water or detergents when cleaning the fan or fan blades. A dry dust cloth or lightly dampened soft cloth will be suitable for the cleaning.
10. After making electrical connections, spliced conductors should be tured upward and pushed carefully up into outlet box. The wires should be spread apart with the grounded conductor on one side of the outlet box.
11. Electrical diagrams are reference only, different fan light may have different light shade and bulbs.
12. Use only our replacement parts. This equipment has been tested and found to comply with the limits fora class B digital device, pursuant to part 15 of the FCC Rules These limits are to provide reasonable protection against harmful interference ina residential nstallatin. This equipment generates, uses and can radiate radio frequency energy and if not installed and used in accordance with the instructions may causeharmful itererence to radio communications.

Warning:

To reduce the risk of personal injury, use only the two steel screws and washers provided with the outiet box for mounting to the outlet box. Most outlet boxes commioniy used for the support of lighting fxtures are not acceptable for fan support and need to e replaced. consult a qualified electrician if in doubt

To reduce the risk of fire, electric shock or person injury, mount fan to outlet box marked ' acceptable for fan support.

To reduce the risk of personal injury, do not bend the blade brackets (also referred to as fiances) during assembly or after installation. Do not insert objects in the path of the blades.

Tools required for installation



electrical tape

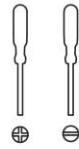

Screwdrivers



Herringbone ladder



tape pliers



Power Drill
(optional)



Drill Bit
(optional)

What to Expect with Your Installation

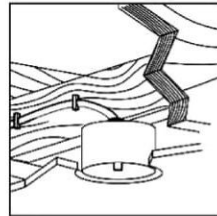

- Must be able to fix the fan to building structure or fan-rated outlet box

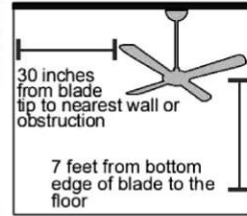

- Assess location



- Check box to see fan weight

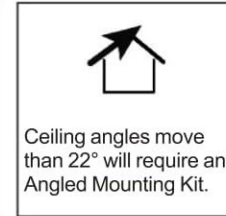

- Assess ceiling angle

Mounting Options

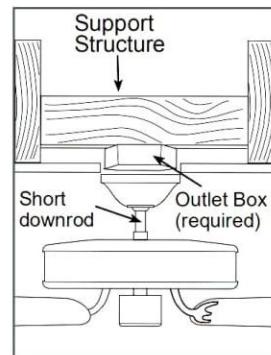

Use short downrod for flat and less than 9 feet ceiling.

Installation steps and instructions

1.Components list

Part Name	Part Picture	Part Qty	Part Name	Part Picture	Part Qty
Bracket		1 PC	Led Board		1 PC
Down Rod		1 PC	Remote Control		1 PC
Up Canopy		1 PC	Lamp Shade		1 PC
Bolt & pin cover		1 PC	Spare Parts		1 PC
Main Body		1 PC	Longer Down Rod		1 PC

2. Mounting bracket installation

(Fig.2)

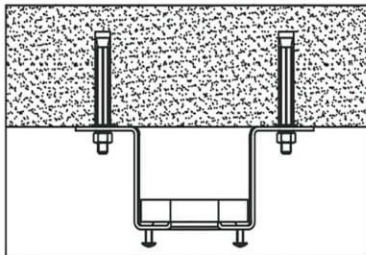

(1) . Concrete ceiling: Drill two holes with an appropriate depth by a drilling bit with dia. at 8mm, and insert two pieces expansion screws in the holes, then fix the hanger bracket into the expanding screws with the wood screws and tighten it by the nuts of the expansion screws.(Fig.2)

(3) Pass the power wires through the center hole in the mounting bracket as shown in Fig. 4.

(4) Fix the mounting bracket to the ceiling outlet box with the screws and washers.

(Fig.3)

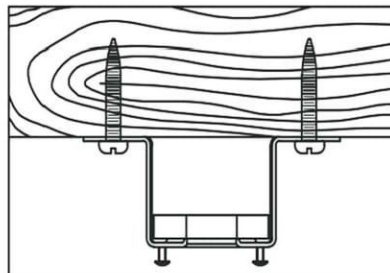

(2) .Wood ceiling: Fix the mounting bracket to the wood ceiling with (thickness at 7cm at least) by 4 wood screws, (Fig.3)

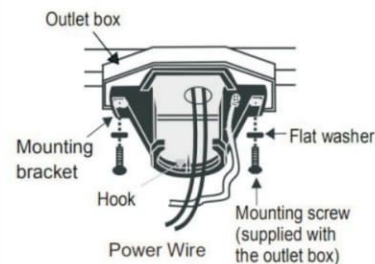

Clean And Care

To clean, wipe fixture with soft cloth. Spray from chemical cleaners can discolor the finish of fixture. Do not use scouring pads, powders, steel wool or abrasive paper to clean this fixture.

Ordering Parts

Keep this manual for future reference, and in case replacement parts are needed. Available parts can be ordered from place of purchase. Use exact wording from diagrams when ordering parts.

Trouble Shooting

1. Fan doesn't work

- Press a fan speed button (Low Mid Hi).
- Check the remote control battery (prepare effective new batteries).
- Check the circuit breaker to ensure the power is turned on.
- Make sure the blades spin freely.
- Turn off power from the circuit breaker, then loosen the canopy and check all the connections according to the wiring diagram.

2. LED panel doesn't light up

- Check the wire connectors to see if all of them are connected correctly.
- Check the circuit adapter to see if it's inserted in the ending slot of the LED panels.

3. LED light doesn't turn off

- Adjust the LED panels make sure that LED panel and LED driver are connected to the motor pan by magnets instead of touching directly.
- If above step doesn't help, please use the insulation tape to cover each magnet of the LED panels and LED driver; then attach the panels and driver as above step.

4. Fan noisy operation

- Tighten the light fitting
- Re-tighten all screws on bracket, downrod and fan blades (do not over tighten)
- Check to see if any of the blades are cracked. If so, replace all of the blades.
- Make sure to only connect the fan onto your ON/OFF switch if you have one, not a dimmer switch.

5. Remote does not work

- Make sure the batteries are installed correctly.
- Make sure the remote control is at the right distance from the fan.
- Install new batteries.

6. Excessive wobbling

- Tighten all of the blades screws until they are snug
- Turn the power off, support the fan carefully, and check that the hanger ball is properly seated.

3. Light kit installation

(1) Assemble the canopy and adapter cover as Fig. 5.

(2) Remove the bolt, pin and set screws from the top of the fan motor assembly.

(3) the wires on the motor thread through the downrod

(4) Align the holes at the bottom of the downrod with the holes in the collar on top of the motor housing (Fig. 5). Carefully insert the bolt through the holes in the collar and downrod. Be careful not to jam the bolt against the wires inside the downrod. Insert the pin to the end of the bolt (Fig. 5).

(5) Fix the downrod with set screws provided.

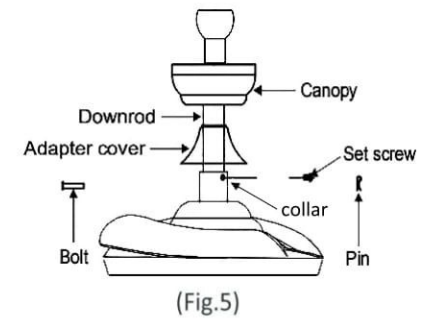

(Fig.5)

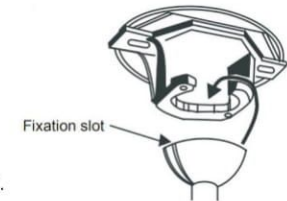

(Fig.6)

4. Hanging the Fan

(1) Place the downrod ball into the bracket socket (Fig.6).

Be sure the fixation slot is locked by the bracket.

(2) Rotate the motor assembly until the "Check Tab" on the mounting bracket has dropped into the "Registration Slot" on the hanging ball and seat firmly (Fig.7 Fig.8 Fig.9)

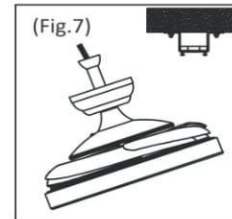

(Fig.7)

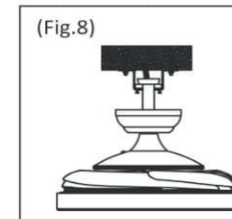

(Fig.8)

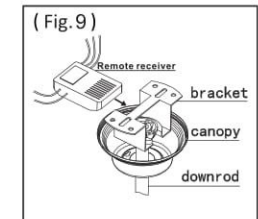

(Fig.9)

5. Wiring.

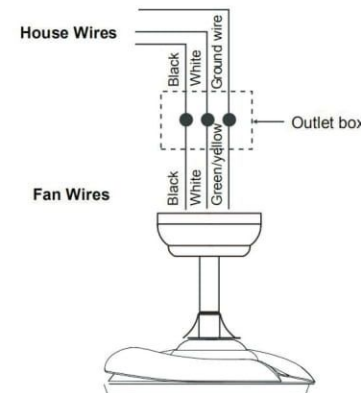

NOTE: THIS FAN ONLY NEEDS ONE

SET OF INPUT WIRES (black, white and ground wire). Both of the fan and lights will be controlled by the remote controller. The wall switch is not able to control the fixture full functionally. **THIS FAN IS ONLY BEABLE TO CONNECTED ONTO ON/OFF SWITCH IF YOU HAVE ONE, BUT NOT FOR DIMMAER SWITCH.**

(1). Connect the live wire (black) to your house live wire (black).

(2). Connect the wire(white) in the middle of the fan the white wire in your house.

- (3). Connect the fan ground wire (from downrod, green/yellow stripe) to your house ground wire(optional).
- (4). After connecting the wires, spread them apart so that the live wires are on one side of the outlet box and the middle wires are on the other side.

6. Attaching the Canopy

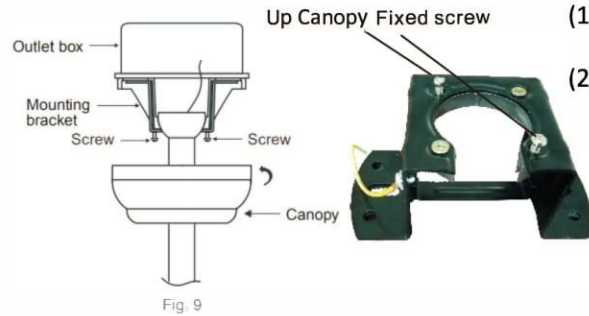

Fig. 9

- (1). Insert the wires and wire connectors into the outlet box.
- (2). Slide the canopy up-to the ceiling and attach it to the mounting bracket with the screws provided. Tighten all screws.



Step 4. Connect the seven-color bluetooth driver cable on the lampshade with the seven-color bluetooth driver cable on the chassis of the fan lamp host.



Step 5. Install the lampshade counterclockwise on the chassis of the main fan lamp.

7. Installing Bulb and Light Shade



Step 1. Prepare the assembled fan lamp host.



Step 2. The LED light source and the LED and Bluetooth integrated driver are mounted on the chassis by means of magnets.

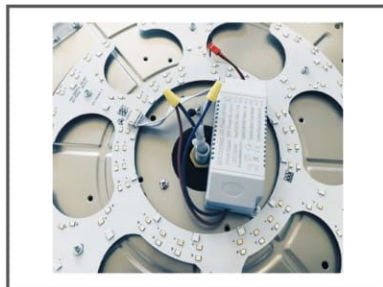

Step 3. Wiring diagram of LED and Bluetooth integrated driver and LED light source.

NOTE:

1. Wire connector maybe different from the picture.
2. Please make sure the LED panels will not touch with the LED driver, the frame and the fan base except for the magnets.
- 3.If any parts are damaged or lost, please contact customer service for replacement