

Hall Tree

Assembly Instruction-please keep for future reference

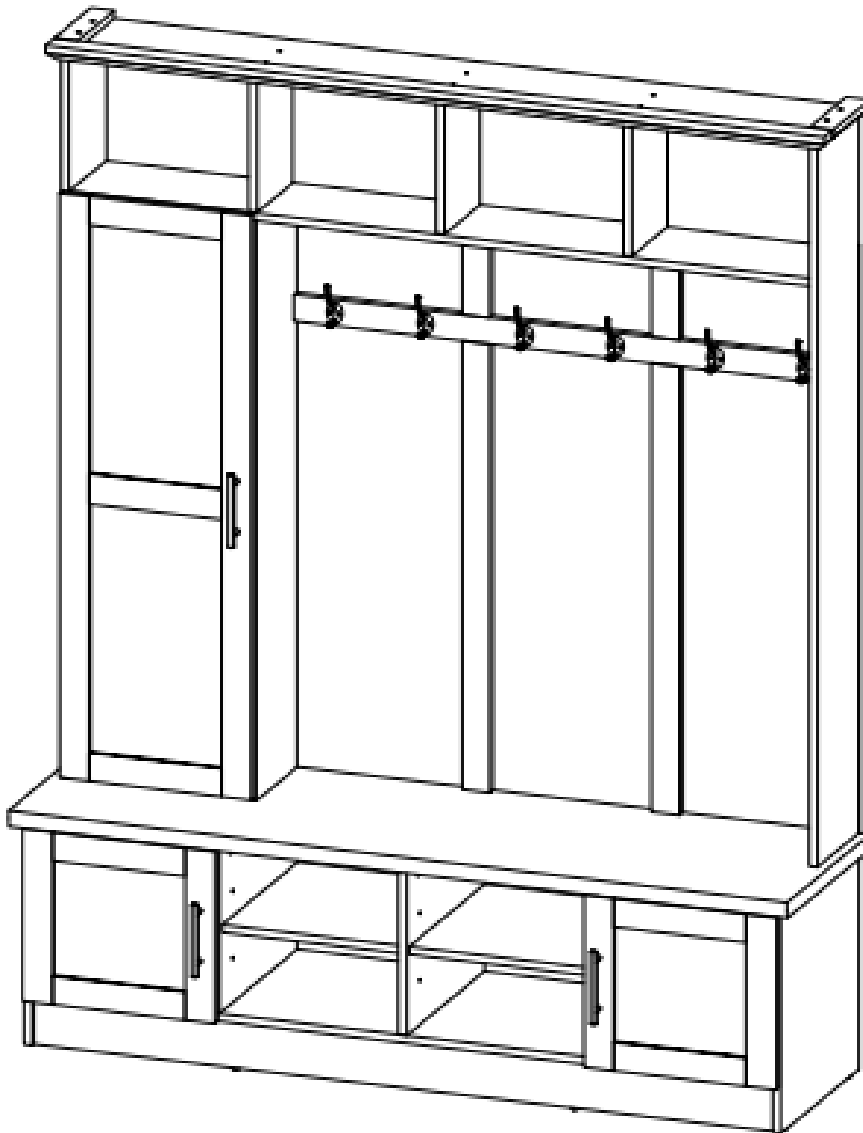

Dimensions

Width-55.12inch
Depth-15.55inch
Height-72.84inch



WARNING



This product is NOT a Clothing Storage Unit (CSU).
DO NOT use it for clothing storage.
Improper use may cause furniture tipover.

Important-please read this instructions fully before starting assembly



Safety and Care Advice

Important – Please read these instructions fully before starting assembly

- Check you have all the components and tools listed on the following pages.
- Remove all fittings from the plastic bags and separate them into their groups.
- Keep children and animals away from the work area, small parts could choke if swallowed.
- Make sure you have enough space to layout the parts before starting.

- During assembly do not stand or put weight on the product, this could cause damage.
- Assemble the item as close to its final position (in the same room) as possible.
- Assemble on a soft level surface to avoid damaging the unit or your floor.
- Parts of the assembly will be easier with 2 people.



power drill is set on a low torque setting.

- To reduce the likelihood of damaging your product please ensure that your

Care and maintenance

- Only clean using a damp cloth and mild detergent, do not use bleach or abrasive cleaners.
- From time to time check that there are no loose screws on this unit.
- This product should not be discarded with household waste. Take to your local authority waste disposal centre.

Handy Hints

- Assemble all parts and bolts loosely during assembly, only once the product is complete should you fully tighten the bolts
- Regularly check and ensure that all bolts and fittings are tightened properly.

WARNING

In order to help prevent overturning – please follow these instructions

To help prevent product toppling over please follow the below steps:-

- Use the anti tip stop or wall fixing method provided (if applicable)
- Do not allow children to climb or hang on the furniture
- Do not open more than one drawer at a time
- Do not place heavy items in the top drawers
- Do not place heavy items on top of the furniture, unless the furniture has been designed for this purpose

Using Camlocks

Step 1

Connect the male camlock as directed in the assembly instructions using a screwdriver.

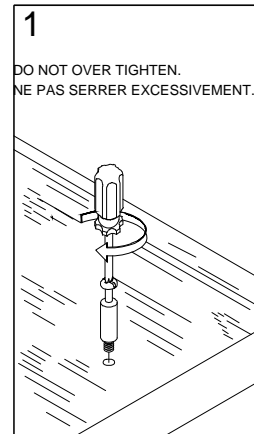

Step 2

Push the male camlock into the entry hole.

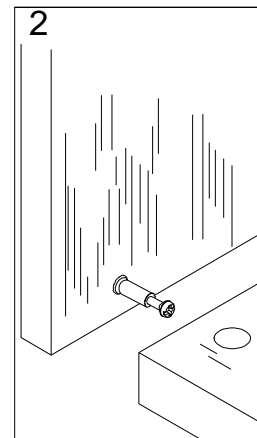

Step 3

Insert the female camlock as shown in the instruction.

Note: ensure that the arrow on the top of the camlock points towards the entry hole for the male camlock.

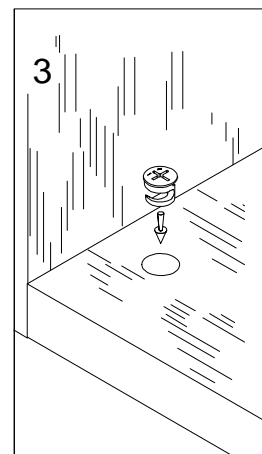

Step 4







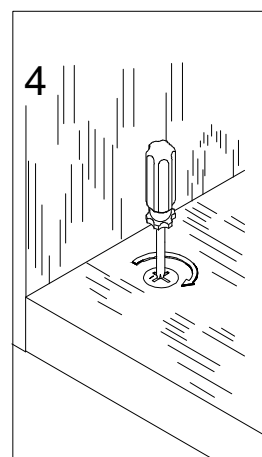

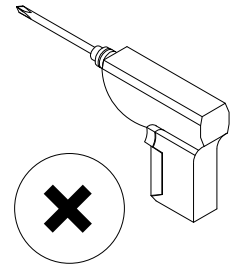
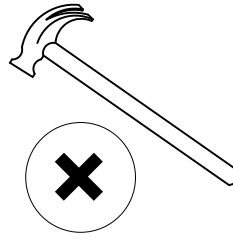
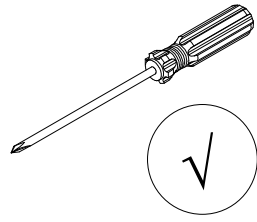
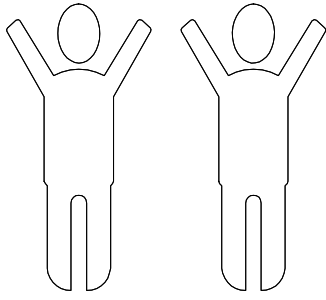

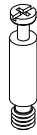

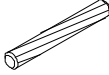
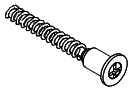
Turn the female camlock clockwise with a screwdriver.

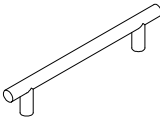
You should feel a click when the camlock is locked in place.

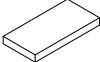
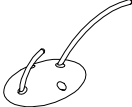
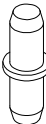
The joint is now secure.

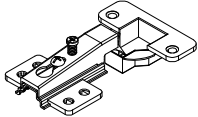

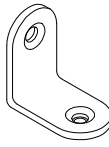
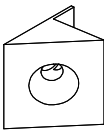

<p>A1</p>  <p>Ø6*35 45PCS</p>	<p>A2</p>  <p>Ø9.5MM 45PCS</p>	<p>B</p>  <p>Ø8*30 64PCS</p>	<p>C</p>  <p>Ø7*50 22PCS</p>
<p>D</p>  <p>Ø3.5*14 111PCS</p>	<p>E</p> <p>BLACK</p>  <p>Ø3.5*14 12PCS</p>	<p>F</p>  <p>3PCS</p>	<p>G</p>  <p>ØM4*18 6PCS</p>
<p>H</p>  <p>Ø30*10 9PCS</p>	<p>I</p>  <p>6PCS</p>	<p>J</p>  <p>16PCS</p>	<p>K</p>  <p>Ø20 20PCS</p>
<p>L</p>  <p>7PCS</p>	<p>M</p>  <p>M1</p>  <p>M2 M6*30</p>  <p>M3 M3.5*35</p> <p>2PCS</p>		<p>N</p>  <p>4PCS</p>
<p>O</p>  <p>14PCS</p>			

N721P447540

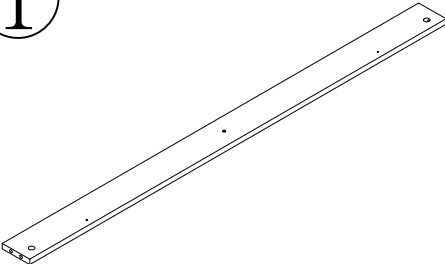
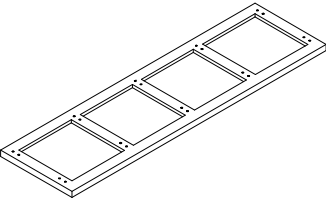
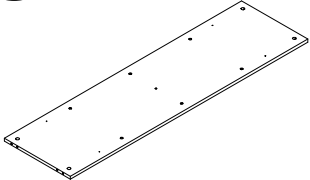
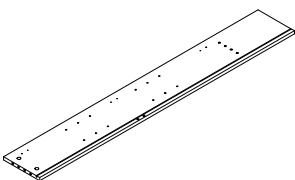
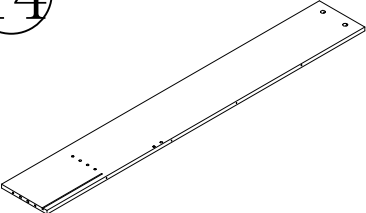
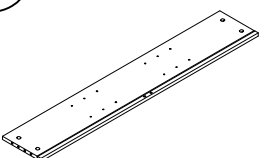
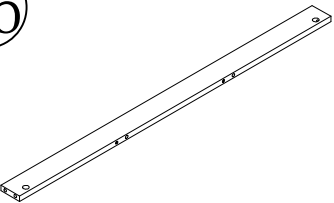
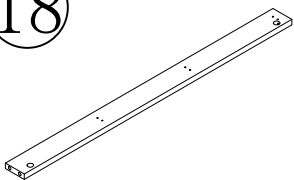
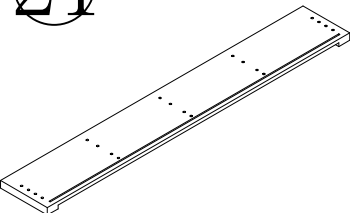
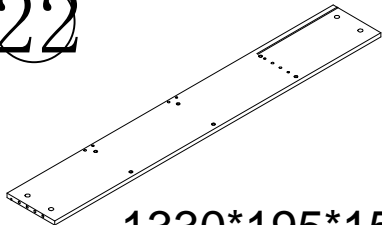
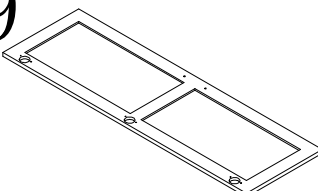
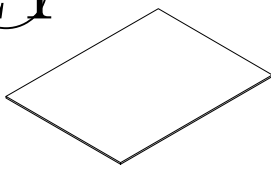
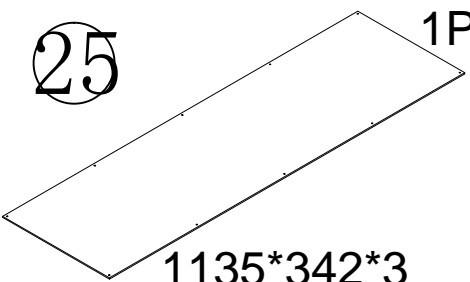
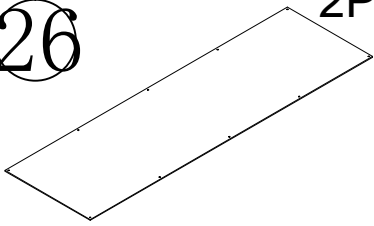
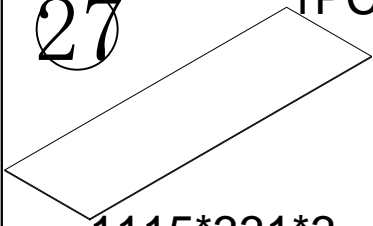
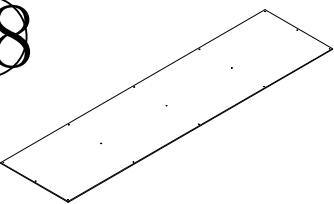
<p>① 2PCS</p>  <p>1330*88*15</p>	<p>⑤ 1PCS</p>  <p>1400*392*30</p>	<p>⑥ 1PCS</p>  <p>1330*370*15</p>
<p>⑬ 1PCS</p>  <p>1370*196*15</p>	<p>⑭ 1PCS</p>  <p>1370*196*15</p>	<p>⑮ 1PCS</p>  <p>1105*195*15</p>
<p>⑯ 1PCS</p>  <p>994*60*15</p>	<p>⑱ 2PCS</p>  <p>855*60*15</p>	<p>㉑ 1PCS</p>  <p>1400*216*30</p>
<p>㉒ 1PCS</p>  <p>1330*195*15</p>	<p>㉔ 1PCS</p>  <p>1114*346*15</p>	<p>㉖ 4PCS</p>  <p>331*260*3</p>
<p>㉘ 1PCS</p>  <p>1135*342*3</p>	<p>㉙ 2PCS</p>  <p>1135*341*3</p>	<p>㉚ 1PCS</p>  <p>1115*331*3</p>
<p>㉜ 1PCS</p>  <p>1358*347*3</p>		

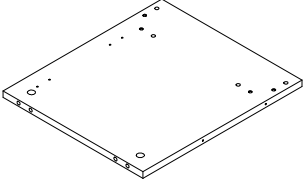
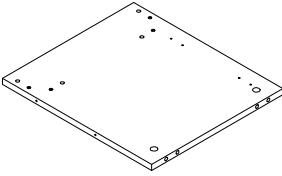
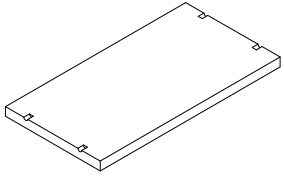
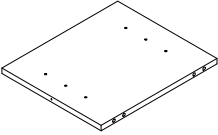
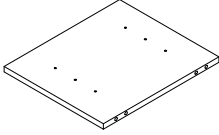
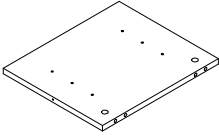
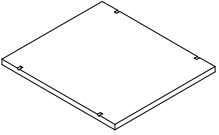
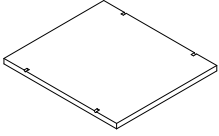
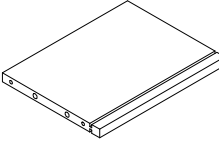
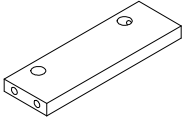
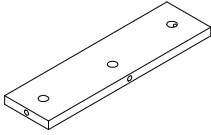
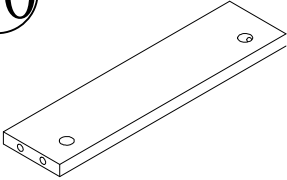
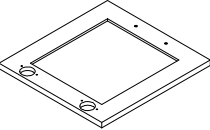
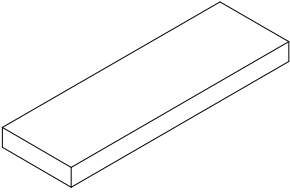

N721P447541

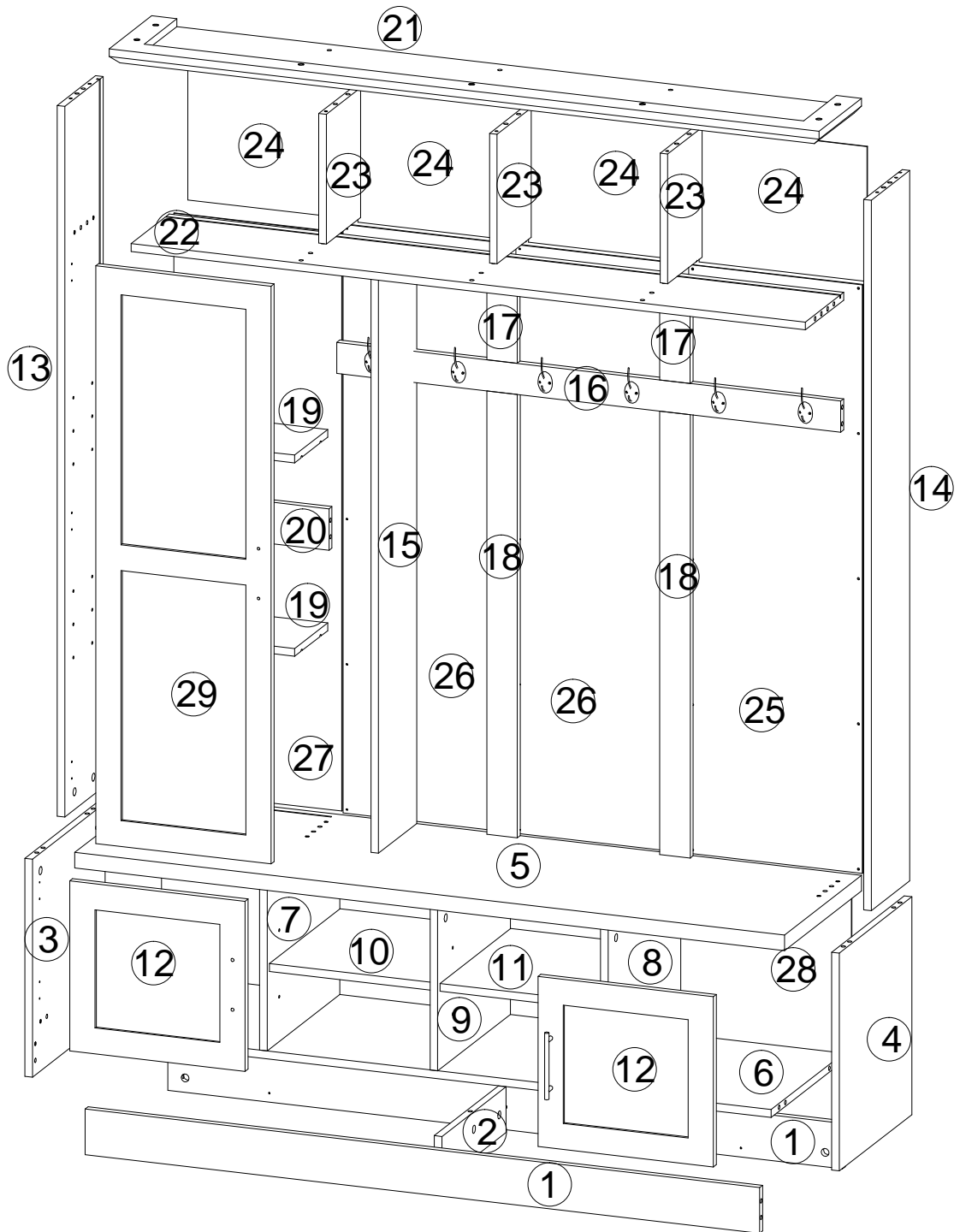
<p>④ 1PCS</p>  <p>420*370*15</p>	<p>③ 1PCS</p>  <p>420*370*15</p>	<p>⑲ 2PCS</p>  <p>320*168*15</p>
<p>⑦ 1PCS</p>  <p>370*317*15</p>	<p>⑧ 1PCS</p>  <p>370*317*15</p>	<p>⑨ 1PCS</p>  <p>370*317*15</p>
<p>⑩ 1PCS</p>  <p>360*320*15</p>	<p>⑪ 1PCS</p>  <p>360*320*15</p>	<p>⑳ 3PCS</p>  <p>250*194.5*15</p>
<p>⑰ 2PCS</p>  <p>190*60*15</p>	<p>② 1PCS</p>  <p>326*88*15</p>	<p>㉑ 1PCS</p>  <p>321*80*15</p>
<p>⑫ 2PCS</p>  <p>346*328*15</p>	<p>Hardware Pack*1</p> 	



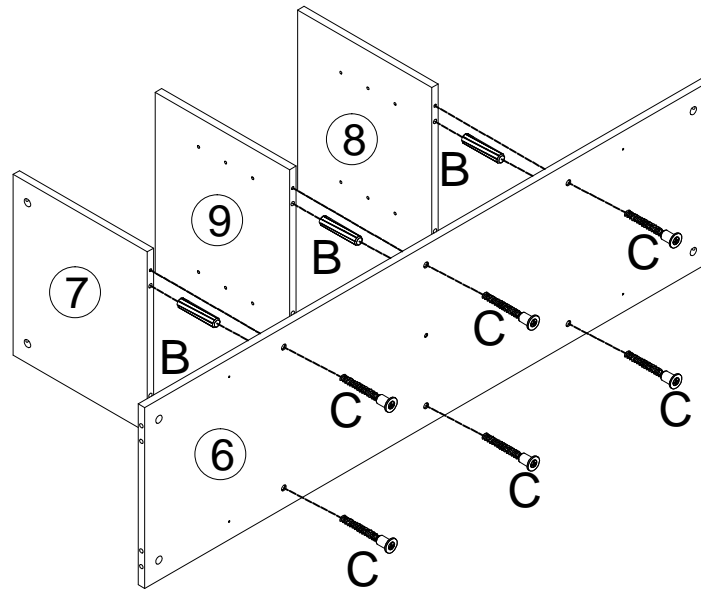



STEP1

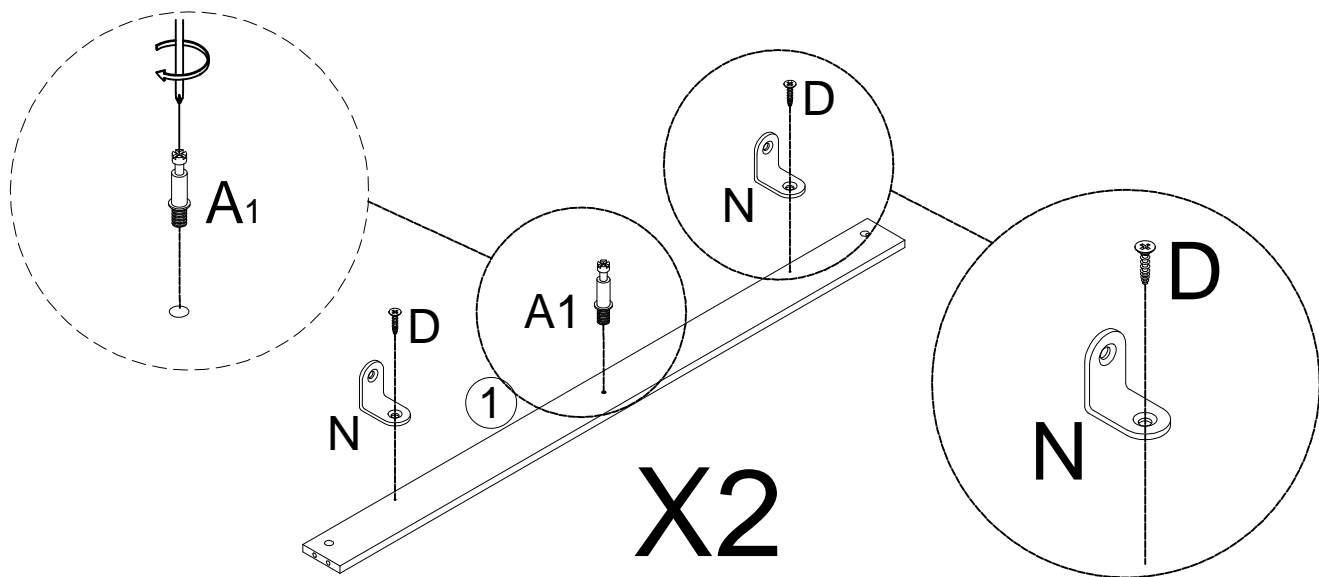

	Bx6PCS
	Cx6PCS

STEP2



	A1x2PCS
	Nx4PCS
	Dx4PCS

STEP3

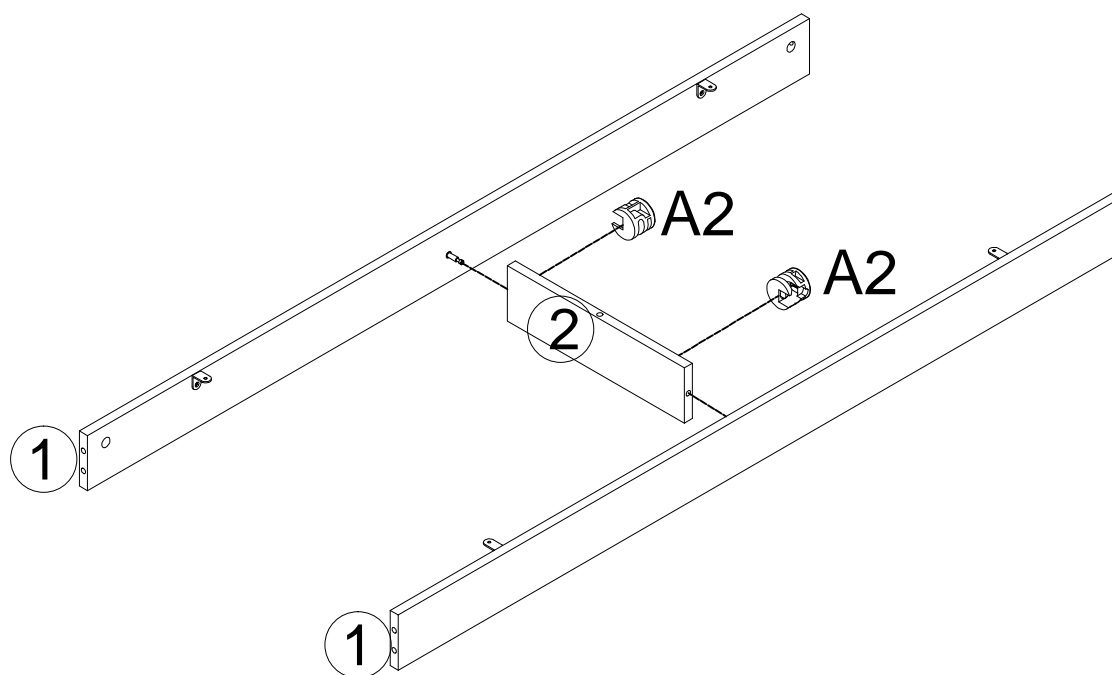

A2x2PCS

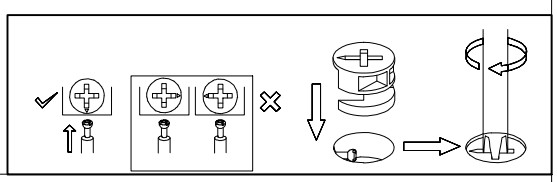

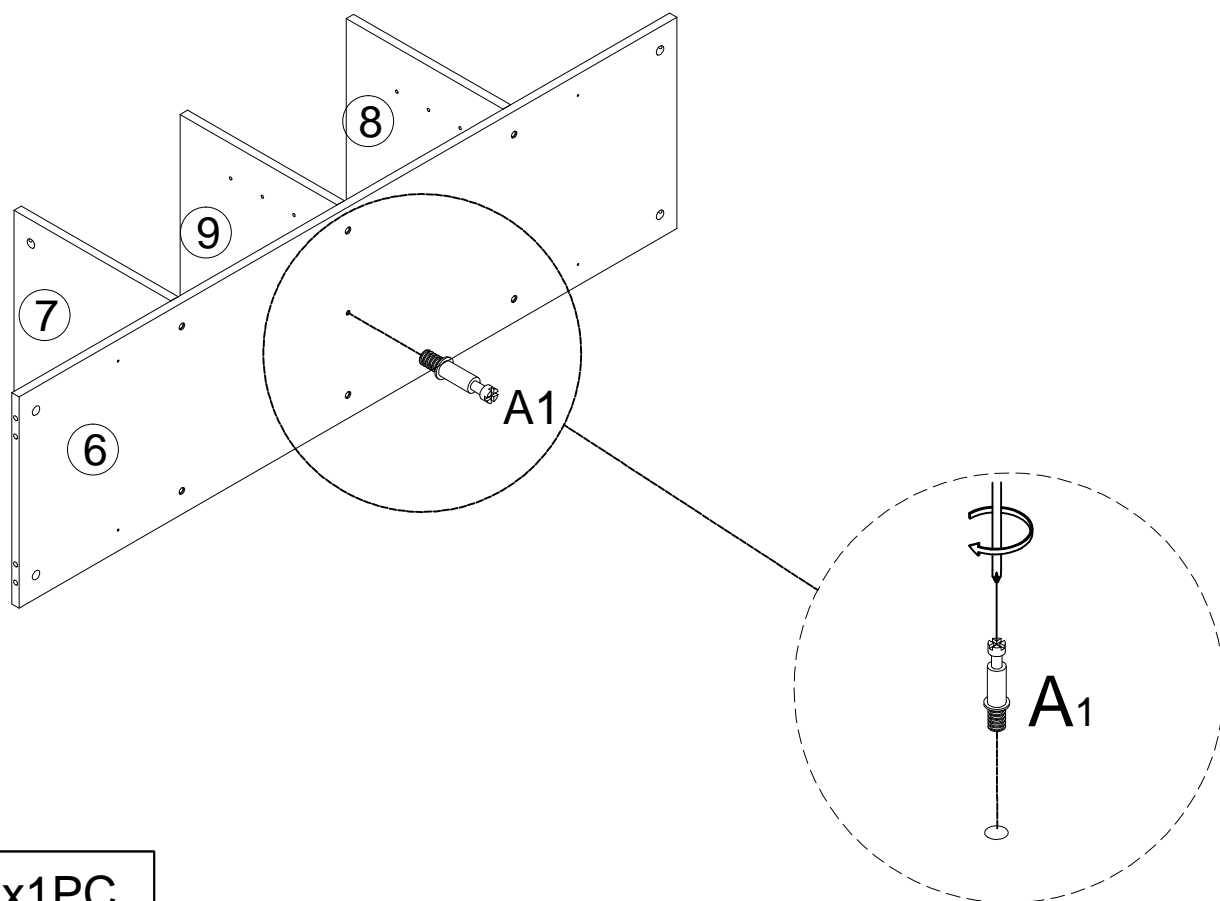

STEP4

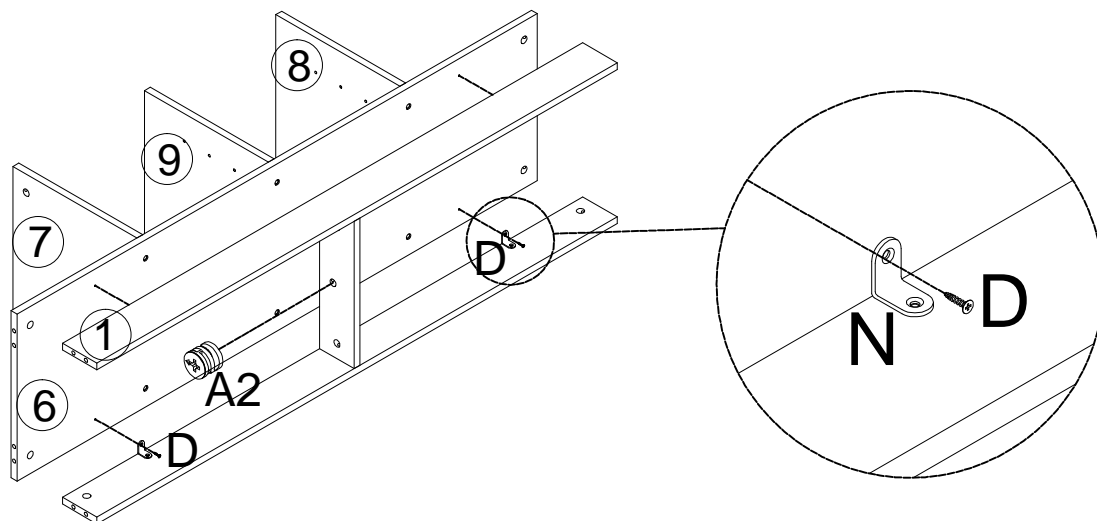

A1x1PC

STEP5



	A2x1PCS
	Dx4PCS

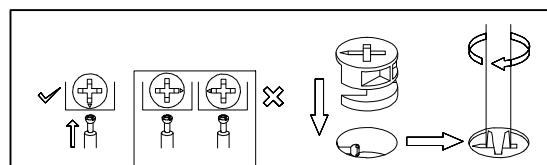

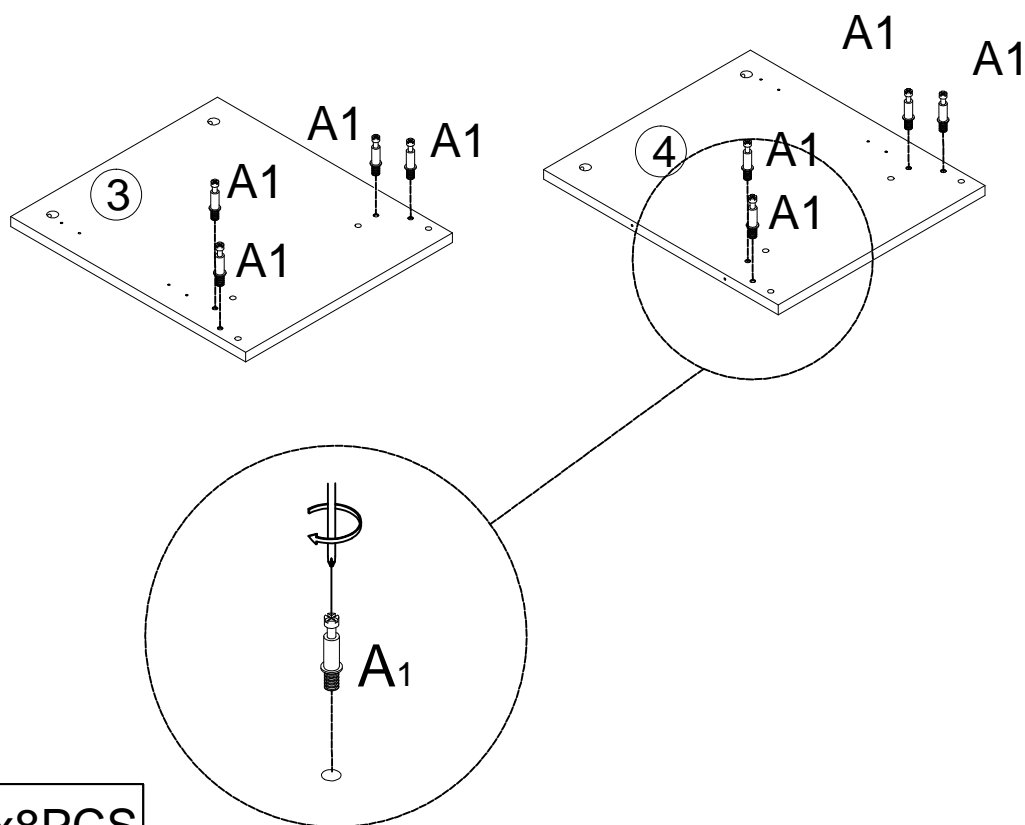

STEP6

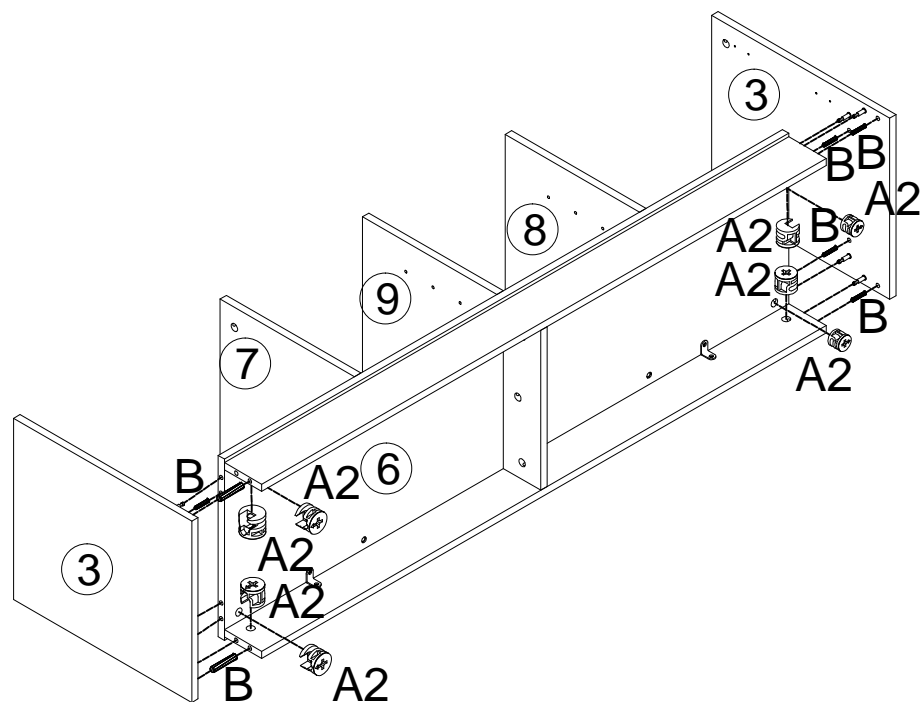

	A1x8PCS
---	---------

STEP7



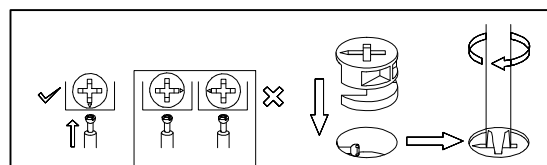

	A2x8PCS
	Bx8PCS



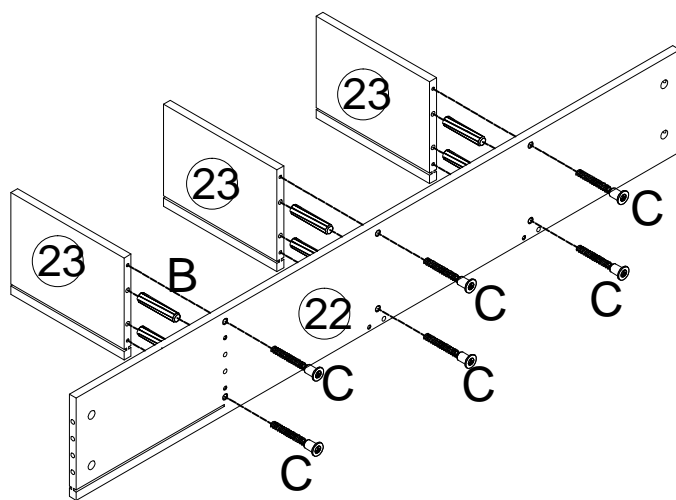

STEP8



	Bx6PCS
	Cx6PCS

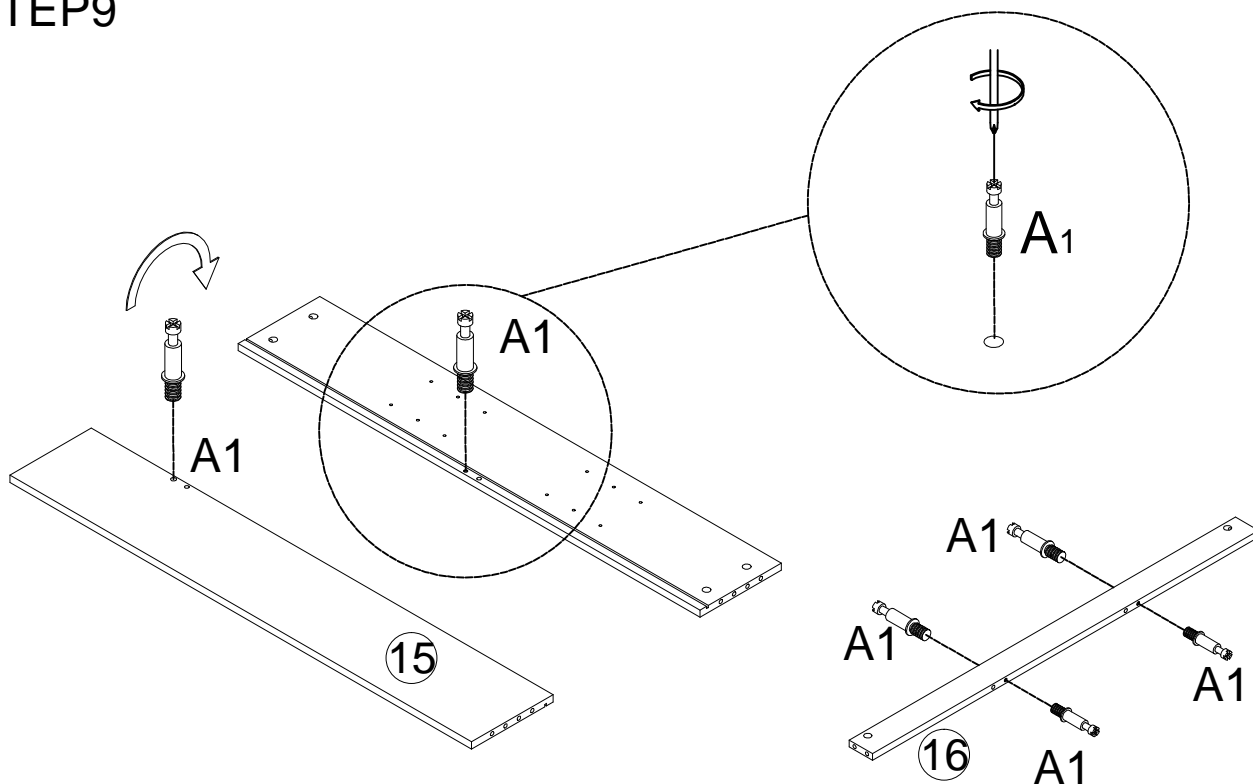

STEP9

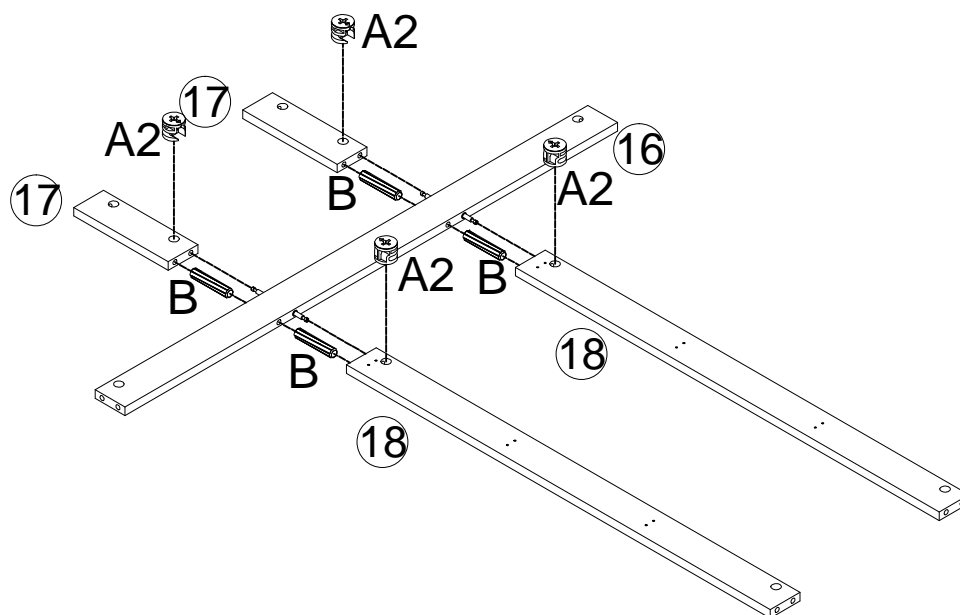

	A1x6PCS
---	---------

STEP10



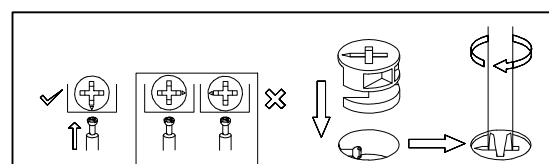

	A2x4PCS
	Bx4PCS

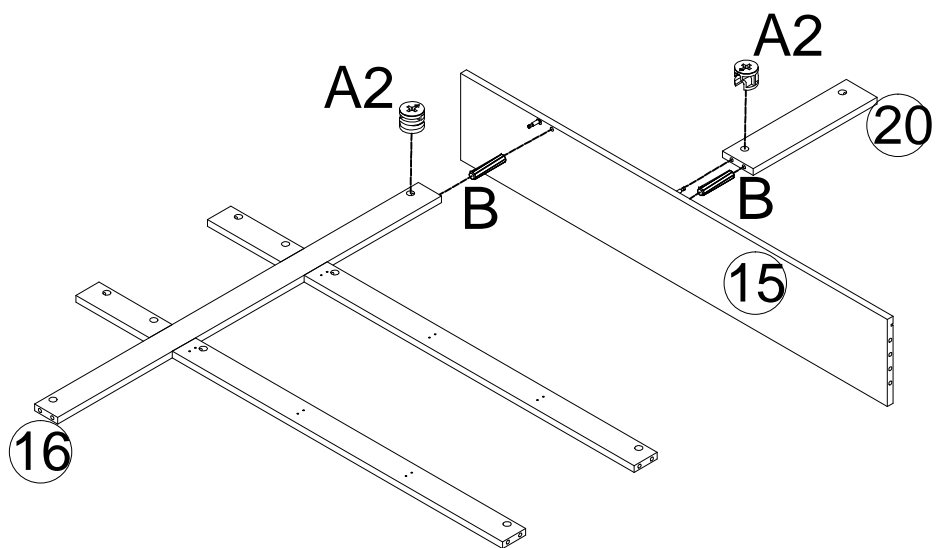

STEP11



Please lift 16,20 with hands during installaion.It's better if two or more people work together on this step.

	A2x2PCS
	Bx2PCS

STEP12

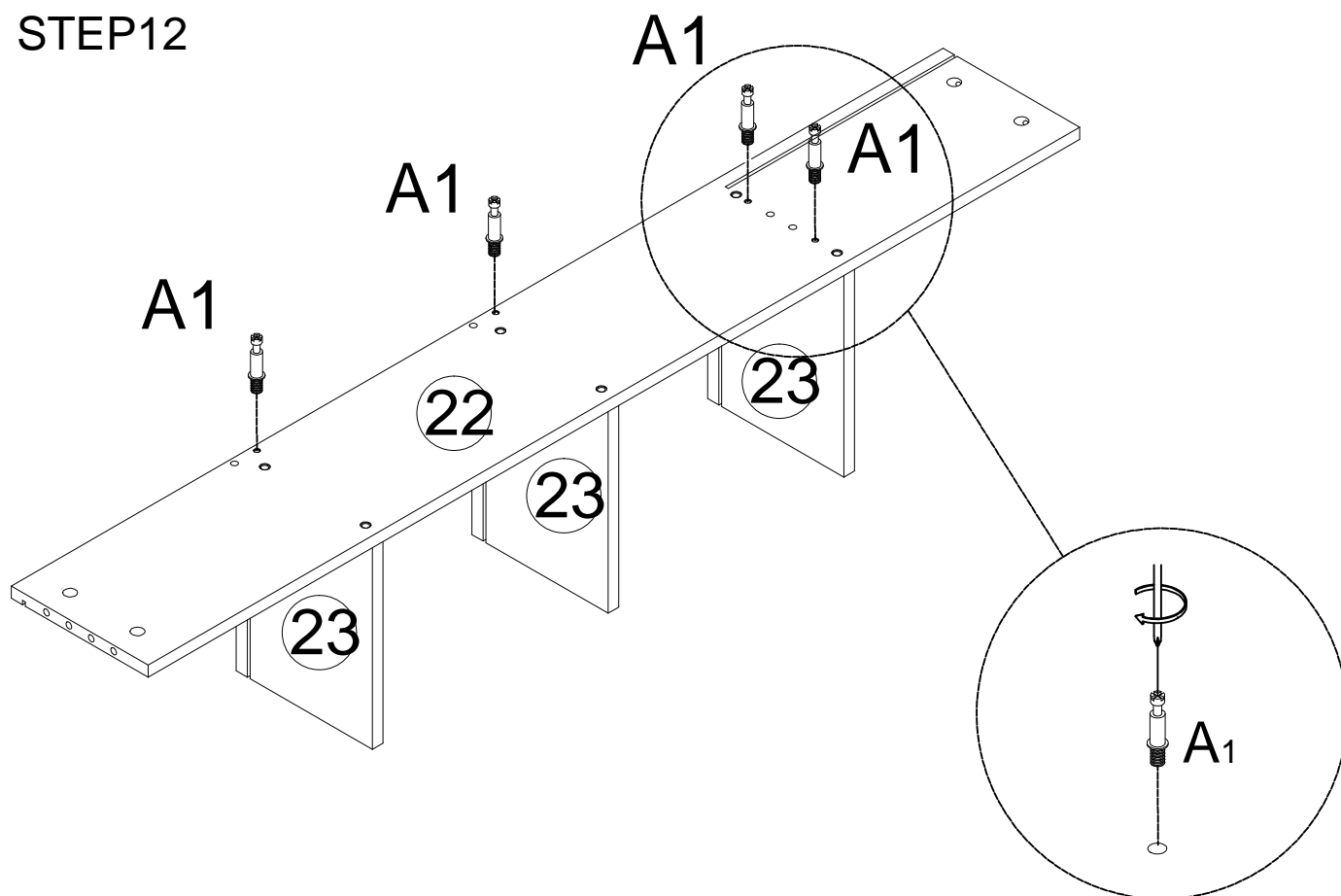

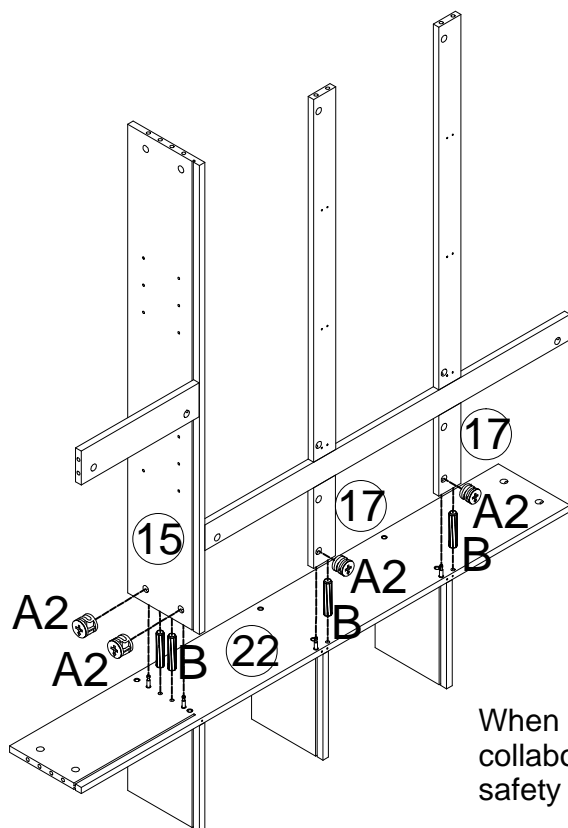

	A1x4PCS
---	---------

STEP13



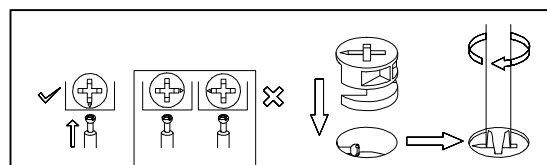

When lifting the table, it requires the collaboration of multiple people, and safety should be taken into consideration

	A2x4PCS
	Bx4PCS



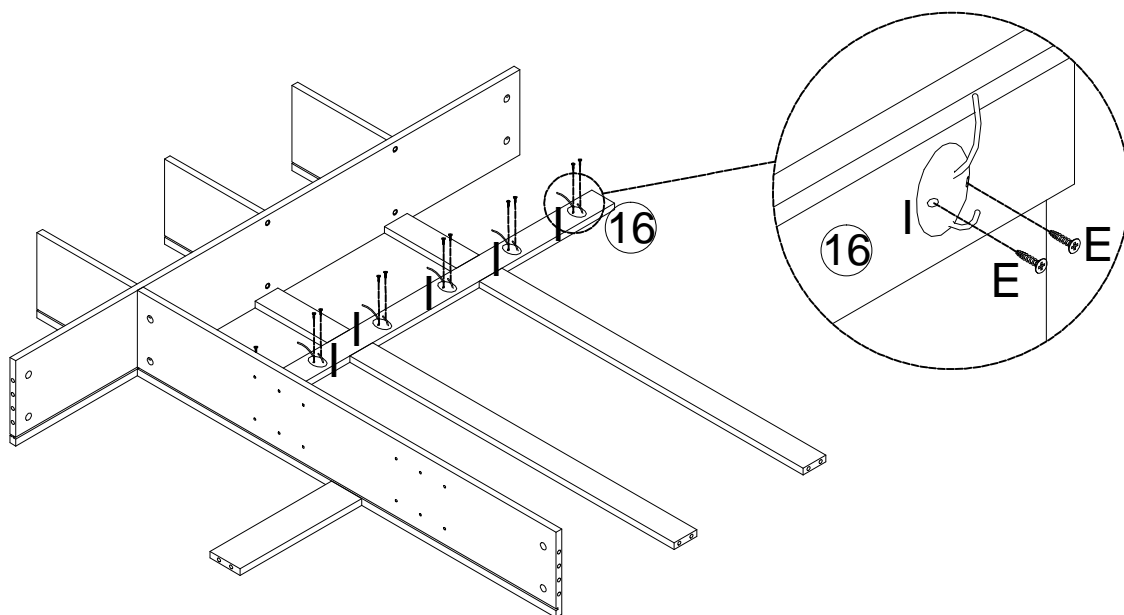

STEP14

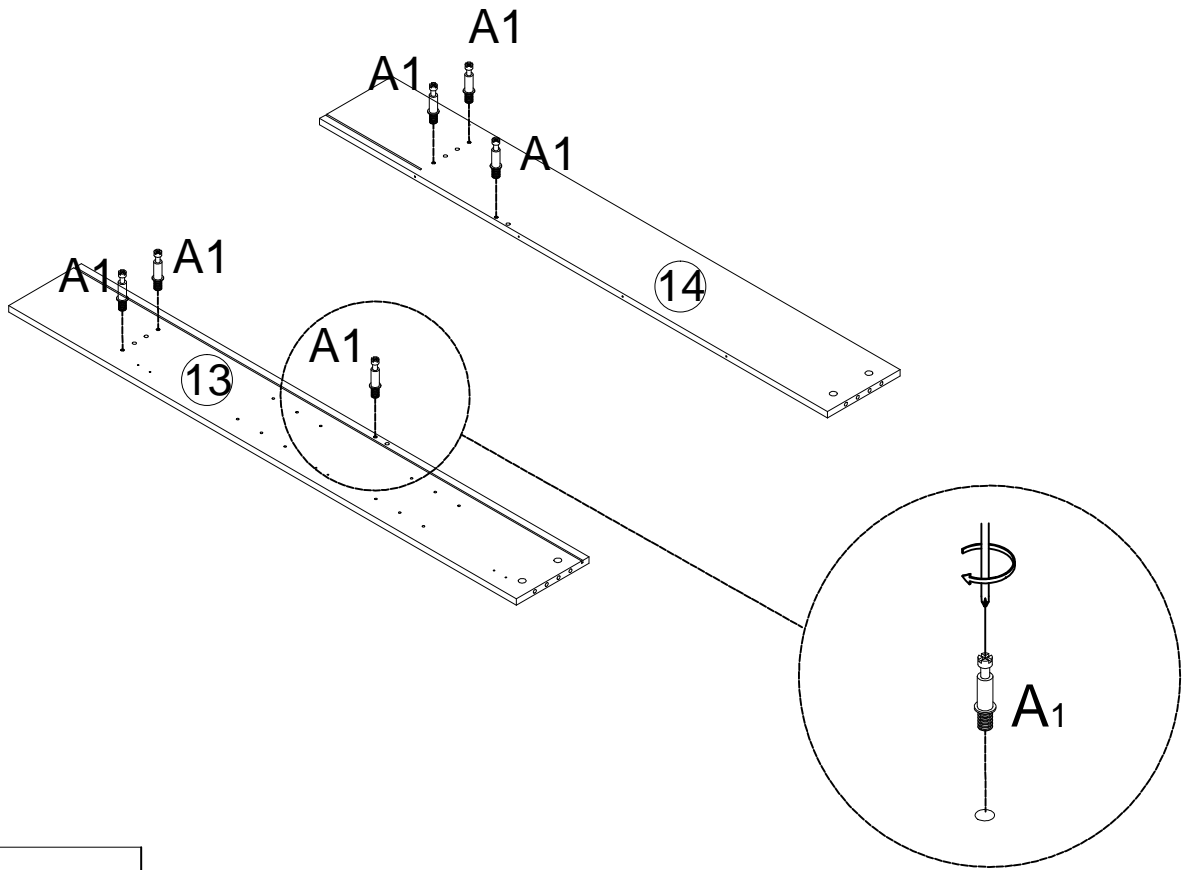

	Ix6PCS
	Ex12PCS

STEP15



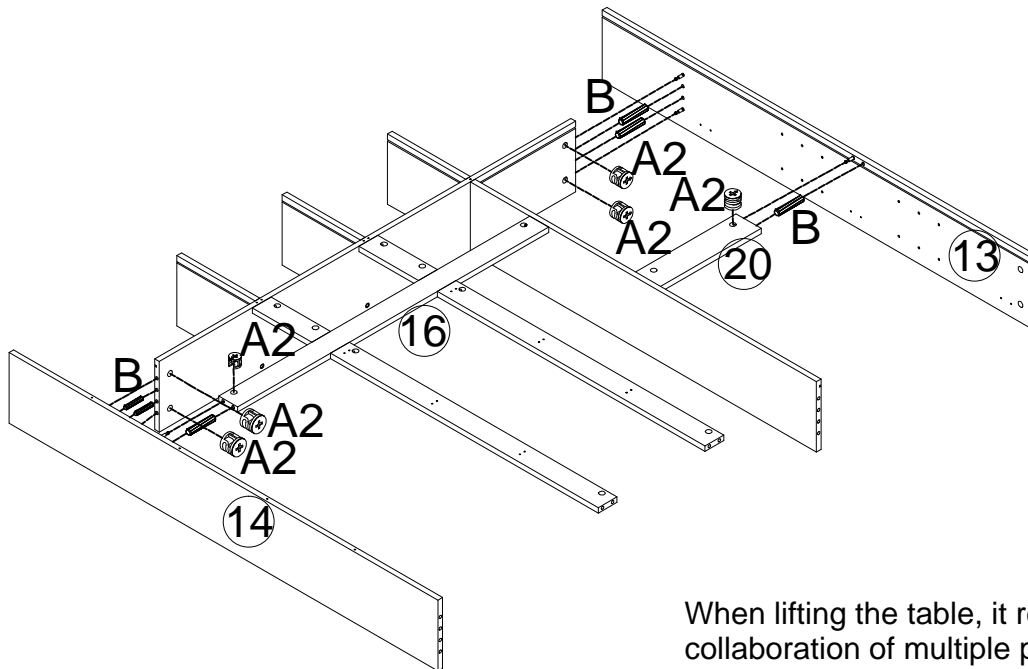

	A1x6PCS
---	---------

STEP16



When lifting the table, it requires the collaboration of multiple people, and safety should be taken into consideration

	A2x6PCS
	Bx6PCS

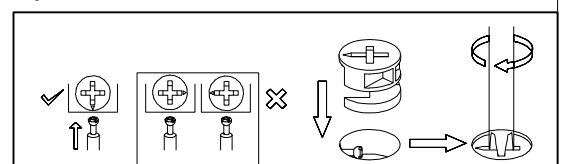

STEP17

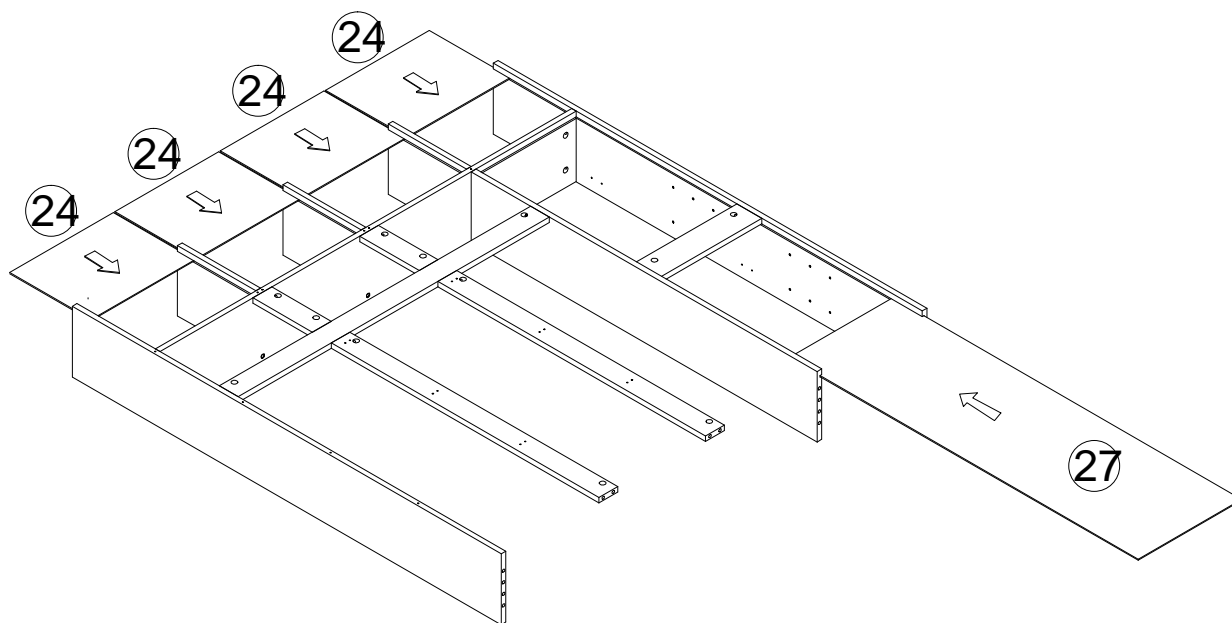

STEP18

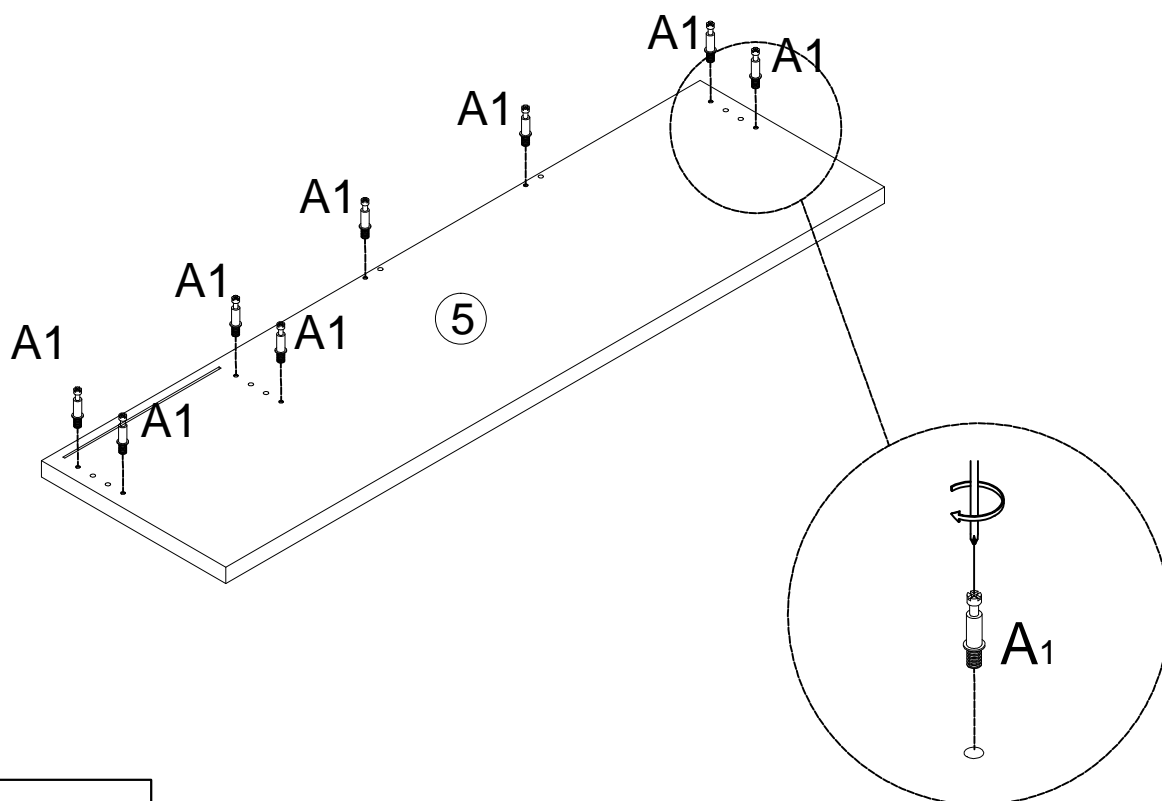



 A1x8PCS

STEP19

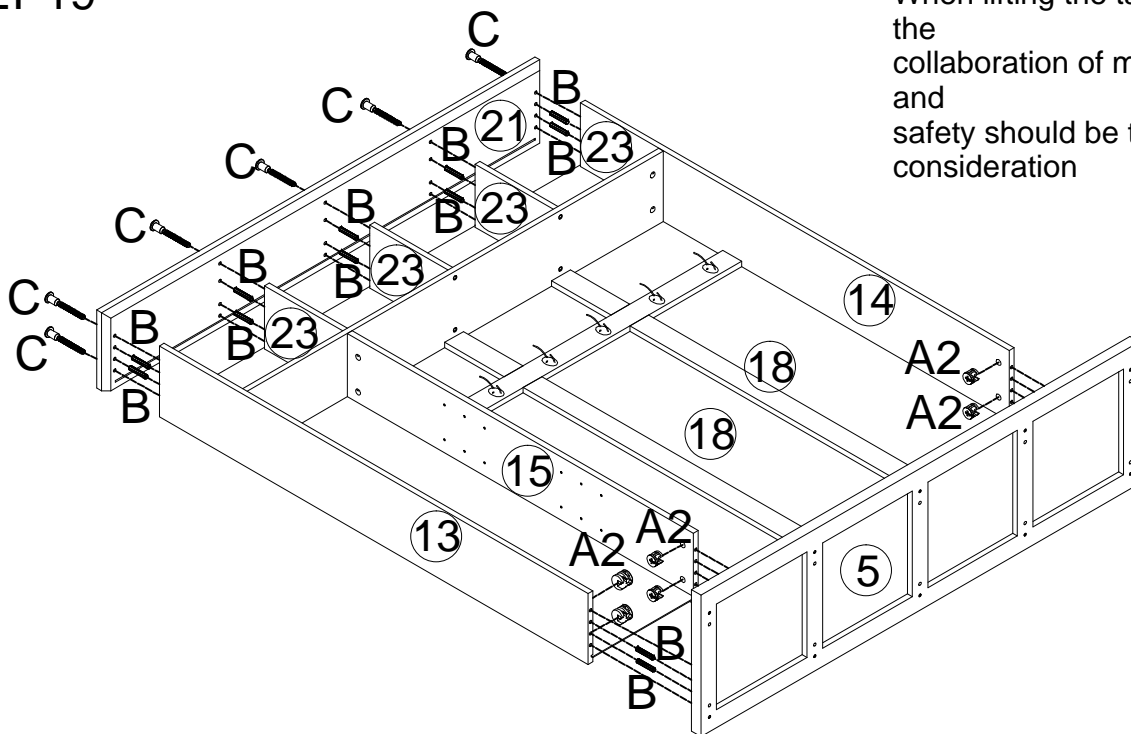
When lifting the table, it requires the collaboration of multiple people, and safety should be taken into consideration



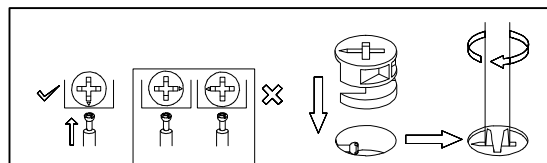

	Cx10PCS
	A2x6PCS
	Bx18PCS



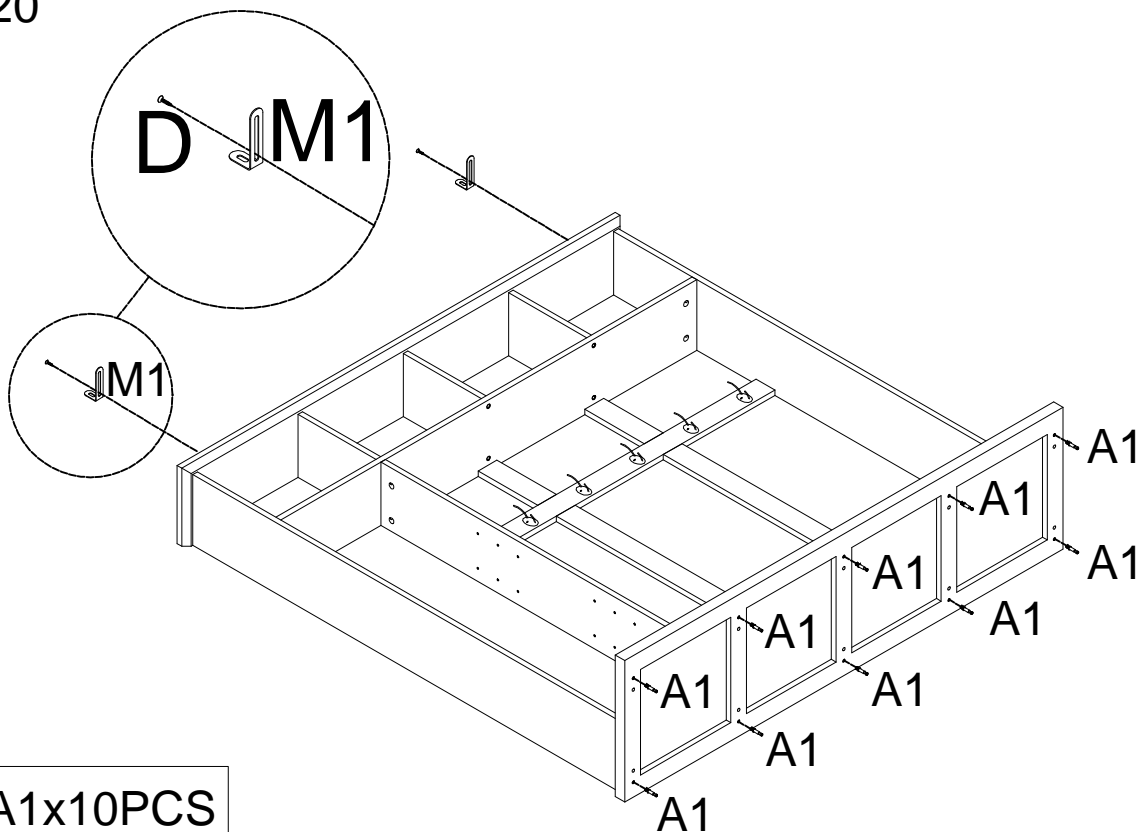



STEP20

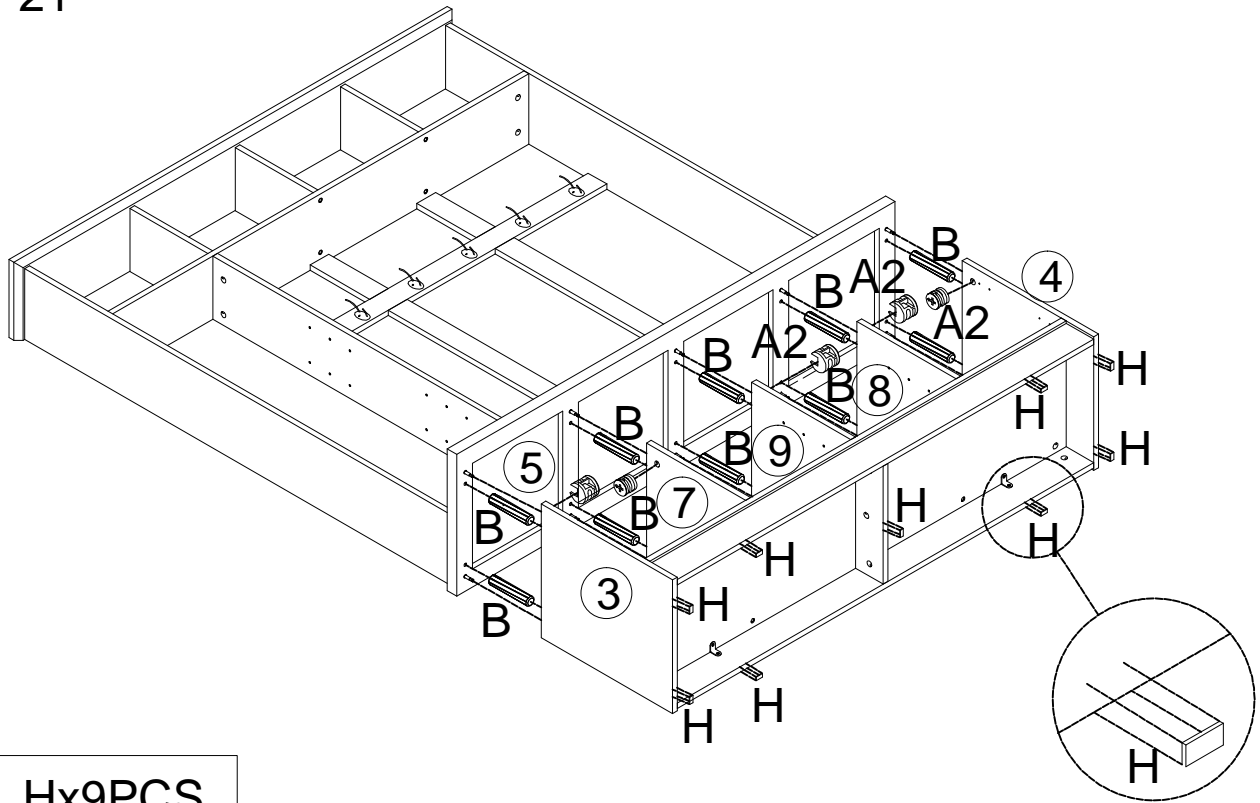

	A1x10PCS
	M1x2PCS
	Dx2PCS

STEP21



	Hx9PCS
	A2x10PCS
	Bx10PCS

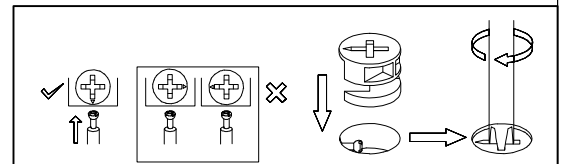

STEP22



When lifting the table, it requires the collaboration of multiple people, and safety should be taken into consideration

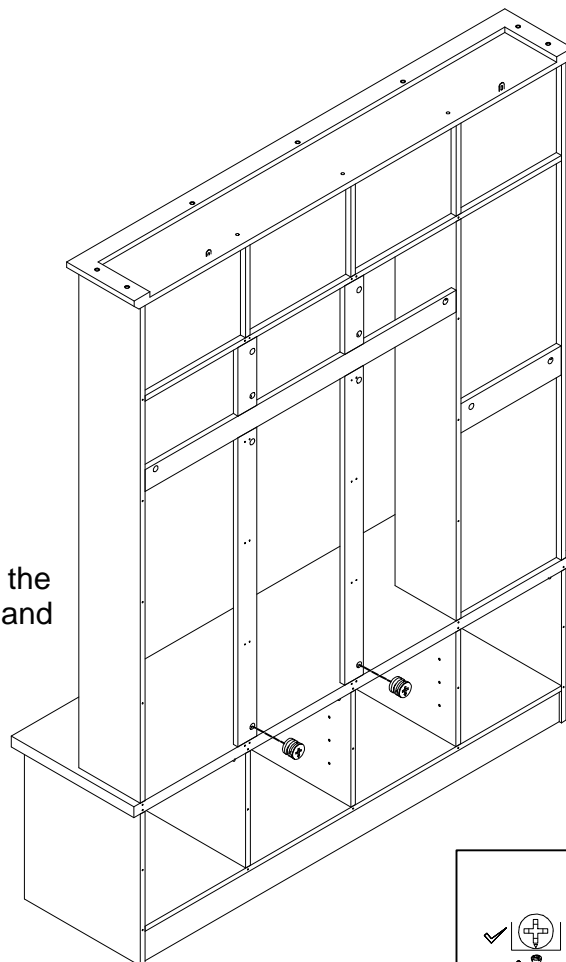

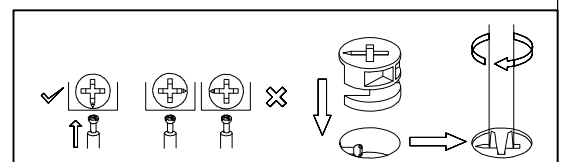

	A2x2PCS
--	---------

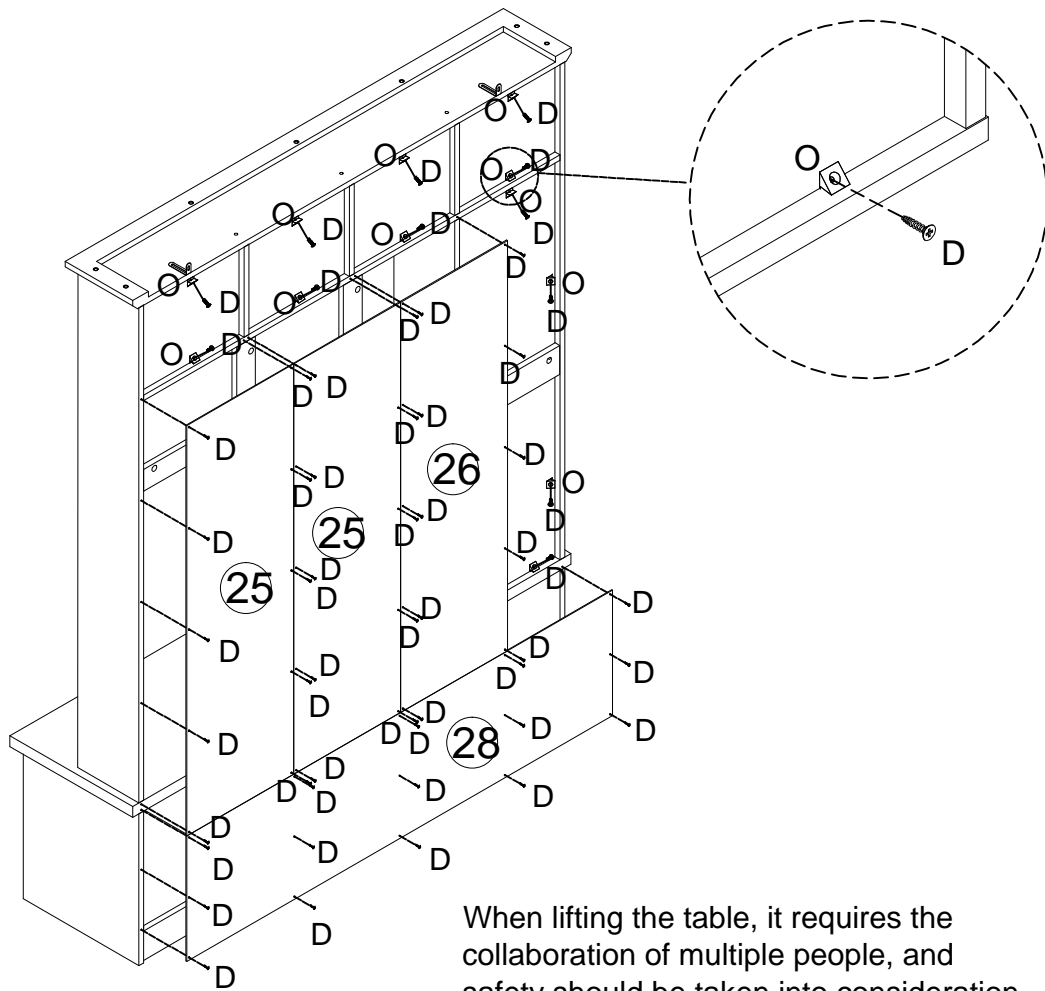

STEP23



	Ox14PCS
	Dx59PCS

When lifting the table, it requires the collaboration of multiple people, and safety should be taken into consideration

STEP24

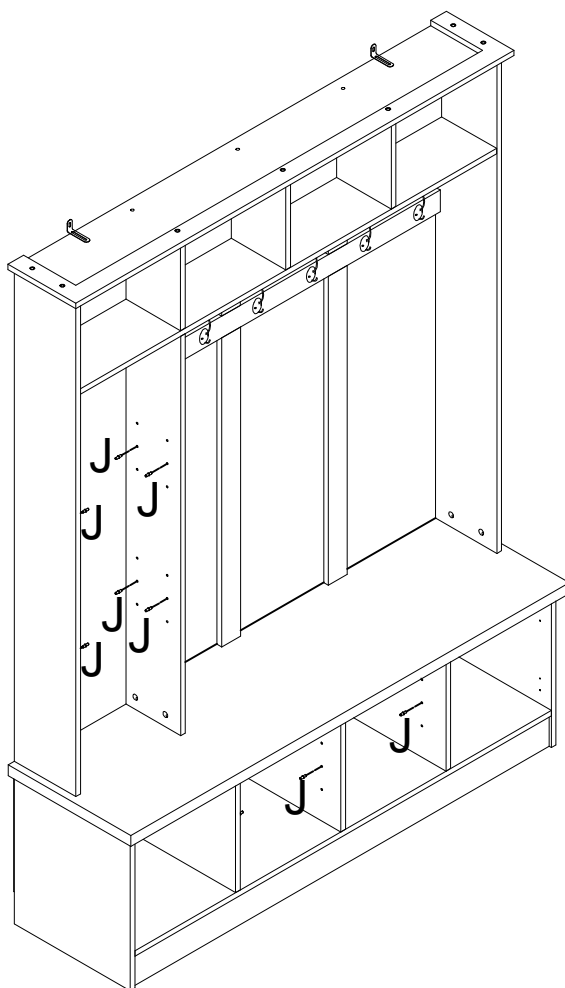

	Jx16PCS
---	---------

STEP25

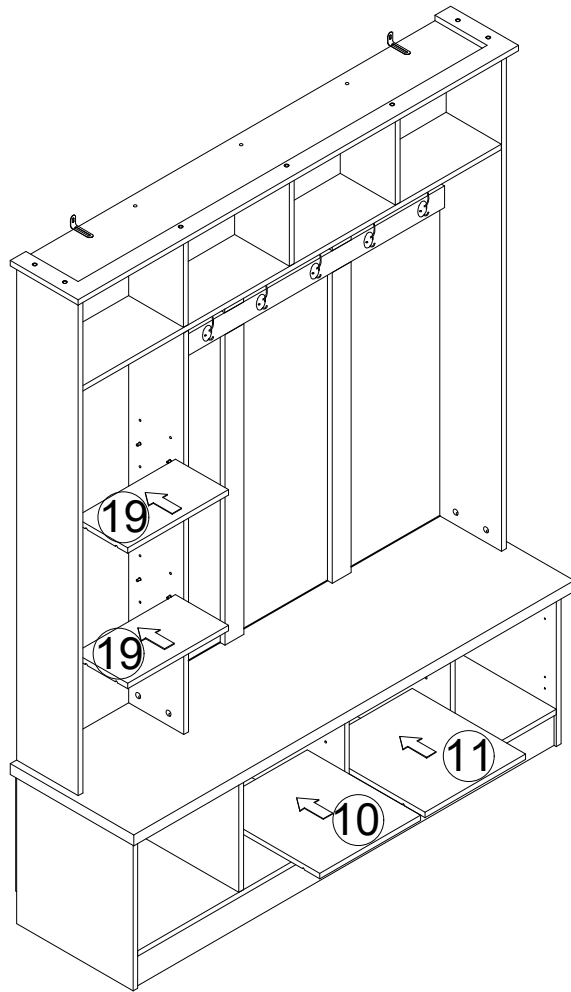

STEP26

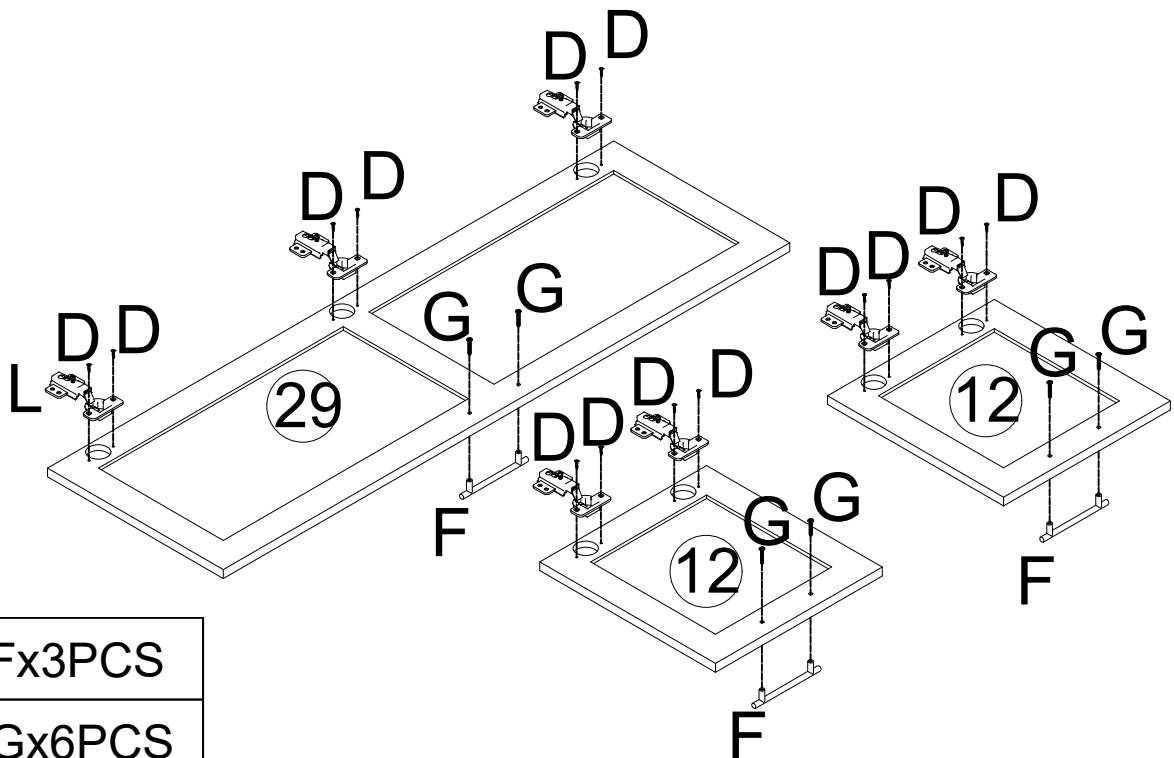

	Fx3PCS
	Gx6PCS
	Lx7PCS
	Dx14PCS

STEP 27

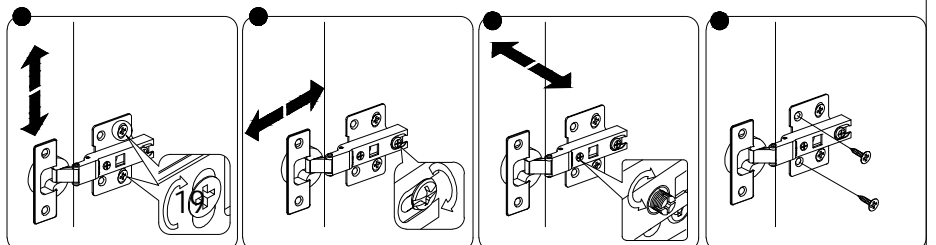
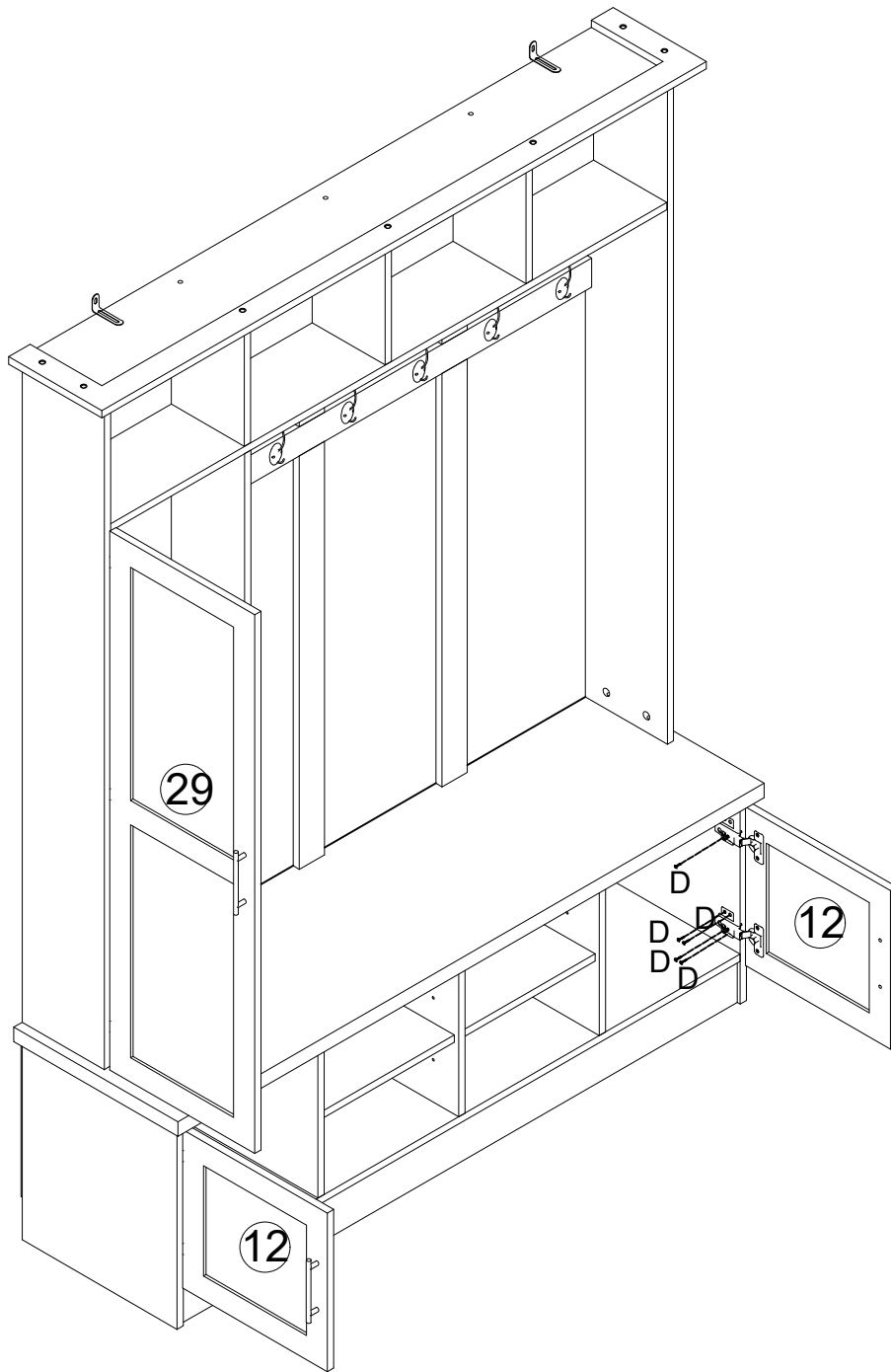

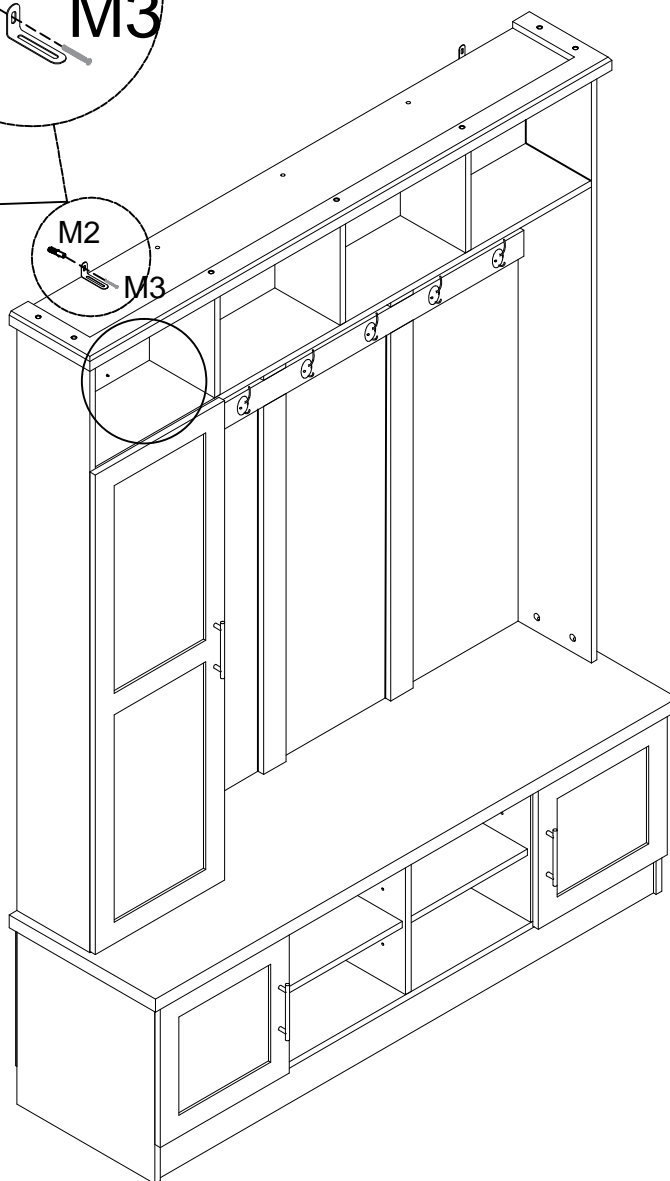
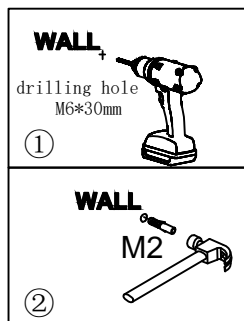
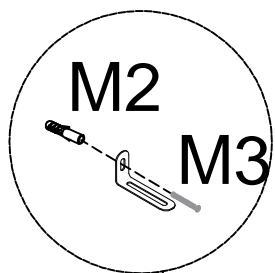

Dx28PCS

STEP28



After the product is installed,
please install the accessory K to
the hardware A2 for the sake of
beauty.

	M3x2PCS
	M2x2PCS
	Kx20PCS

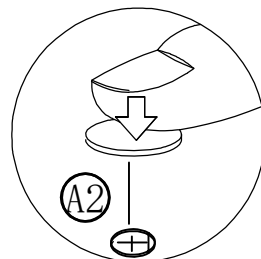
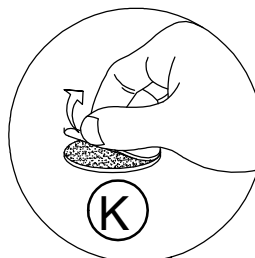

STEP29

