

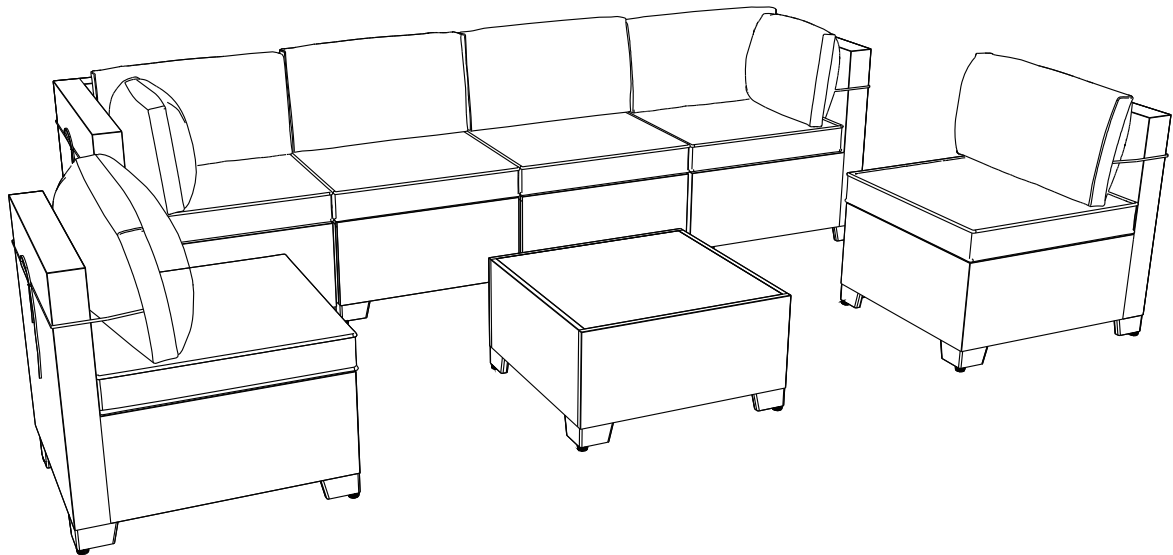

Patio Conversation Set

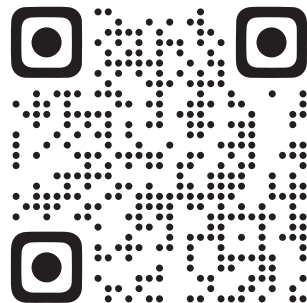

Model:P2507



Scan the QR code to learn more about our product.



WARNINGS

Not for Children

This sofa set is intended for adult use only. Avoid allowing children to play or climb on the furniture to reduce the risk of injury.

No Standing on Furniture

The furniture is designed for sitting only. Do not stand, jump, or place excessive weight on the armrests or backrests.

Avoid Modifications

Do not modify or attempt to repair the sofa set. Contact customer service for any necessary repairs or replacement parts.

Important Safety Information

Choking Hazard: Keep packaging materials, small parts, and screws away from children. This product contains parts that could be harmful if swallowed.

Adult Supervision: Always supervise children around the furniture, especially when playing or climbing.

Stable Surface: For safety and stability, ensure the sofa set is placed on a level, stable surface. Avoid placing it on uneven or slippery ground.

Weight Limit: Please do not exceed the recommended weight capacity for each seating unit and coffee table to prevent damage. Refer to the product's weight specifications for more details.

Cushion Safety: Ensure that cushions and pillows are securely in place before using the furniture. Avoid using the product if any cushions are damaged or misplaced.

Protect from Weather: Although the rattan material is designed for outdoor use, we recommend covering the sofa set or moving it to a sheltered area during heavy rain, snow, or extreme sunlight exposure to protect the cushions and prolong the life of the set.

Proper Assembly: Always ensure that all components are properly assembled and that all screws and bolts are tightened securely before use. Check for loose screws periodically.



CONTENTS

Important.....	1
Packing List.....	3
Assembly steps for armless sofa.....	9
Assembly steps for corner sofa.....	12
Assembly steps for coffee table.....	14
U-shapped connector.....	17
Sofa cover washing instruction.....	18
Maintenance and Care.....	18

CONTACT US

If you have any questions or concerns regarding our product, please don't hesitate to contact our customer service team at [service@outsofas.com]. We are committed to providing excellent service and ensuring your satisfaction.

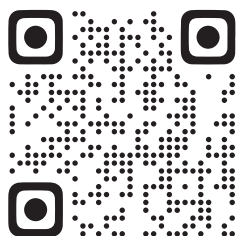

Scan The Qr Code And Click The  Chat Button To Contact us.

Web:www.outsofas.com

E-mail:service@outsofas.com





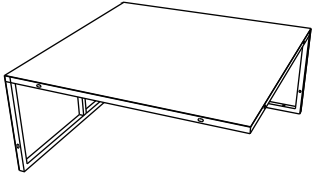
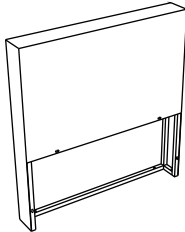
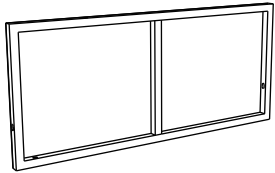
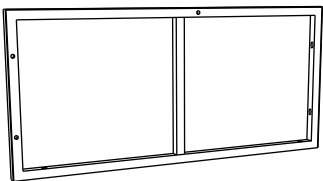
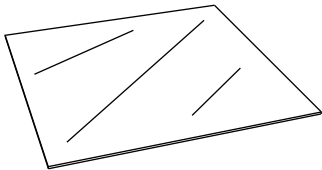
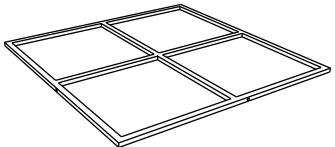
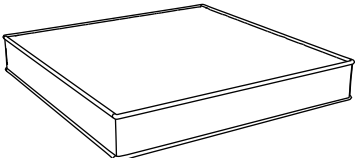
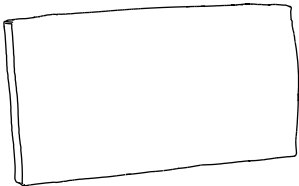
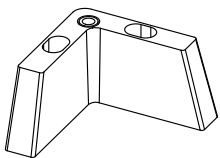
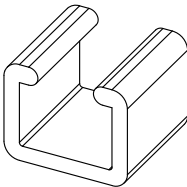
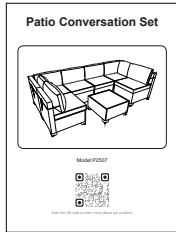
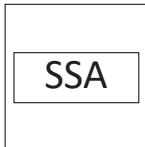

List of Parts in Box A

<p>(A) × 2</p> 	<p>(B) × 2</p> 	<p>(C) × 2</p> 
<p>Sofa Seat Part</p>	<p>Middle Sofa Back Part</p>	<p>Middle Sofa Side Part</p>
<p>(F) × 4</p> 	<p>(G) × 1</p> 	<p>(H) × 1</p> 
<p>Coffee Table Side Part</p>	<p>Coffee Table Glass Top</p>	<p>Coffee Table Connector</p>
<p>(SC) × 2</p> 	<p>(PL) × 2</p> 	<p>(J) × 12</p> 
<p>Seat Cushion</p>	<p>Long Back Cushion</p>	<p>High L-Shaped Feet</p>
<p>(K) × 4</p> 	<p>Instruction × 1</p> 	<p>(SSA) × 1</p> 
<p>U-Shaped Connector</p>	<p>Instruction</p>	<p>Screw Set A</p>



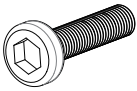
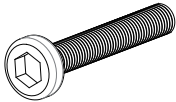
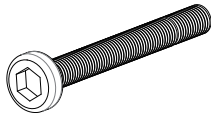

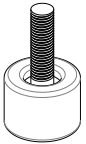
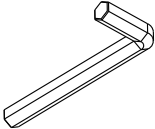
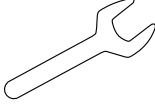
Screw Set A





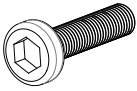
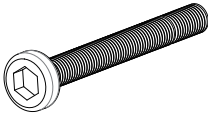

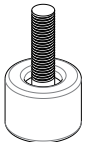
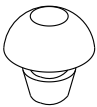
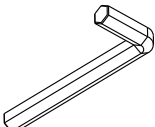
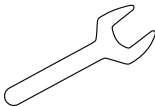
Middle Sofa's Screw × 2

<p>(S) × 3</p>  <p>Bolt M6×35</p>	<p>(Q) × 4</p>  <p>Bolt M6×50</p>	<p>(T) × 8</p>  <p>Bolt M6×60</p>	<p>(R) × 12</p>  <p>Washer Nut</p>
<p>(P) × 4</p>  <p>Adjustable Screws</p>	<p>(W) × 1</p>  <p>Spanner</p>	<p>(V) × 1</p>  <p>Wrench</p>	<p>(O) × 3</p>  <p>Aperture Cover</p>

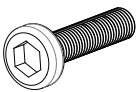
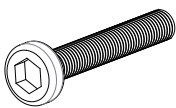
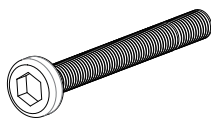
Coffee Table's Screw × 1

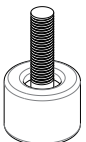
<p>(S) × 8</p>  <p>Bolt M6×35</p>	<p>(T) × 8</p>  <p>Bolt M6×60</p>	<p>(R) × 8</p>  <p>Washer Nut</p>	<p>(P) × 4</p>  <p>Adjustable Screws</p>
<p>(X) × 5</p>  <p>Glass Mat</p>	<p>(W) × 1</p>  <p>Spanner</p>	<p>(V) × 1</p>  <p>Wrench</p>	

Additional Screws-A

<p>(S) × 2</p>  <p>Bolt M6×35</p>	<p>(Q) × 2</p>  <p>Bolt M6×50</p>	<p>(T) × 2</p>  <p>Bolt M6×60</p>	<p>(R) × 2</p>  <p>Washer Nut</p>
<p>(P) × 1</p>  <p>Adjustable Screws</p>	<p>(Y) × 1</p>  <p>Restoration of rattan</p>	<p>(Z) × 1</p>  <p>Velcro</p>	<p>(O) × 1</p>  <p>Aperture Cover</p>

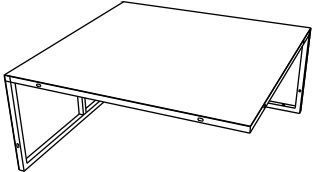
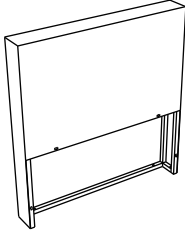
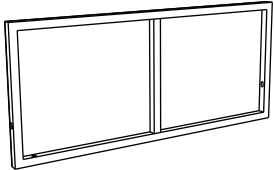
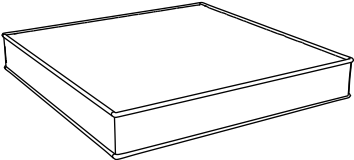
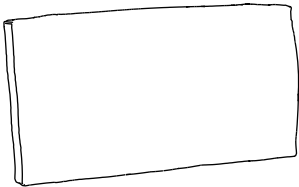
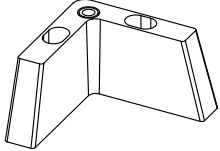
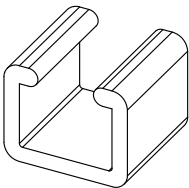
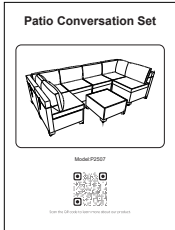
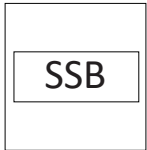

List of Parts in Box B

<p>(A) × 2</p> 	<p>(B) × 2</p> 	<p>(C) × 2</p> 
<p>Sofa Seat Part</p>	<p>Middle Sofa Back Part</p>	<p>Middle Sofa Side Part</p>
<p>(SC) × 2</p> 	<p>(PL) × 2</p> 	<p>(J) × 8</p> 
<p>Seat Cushion</p>	<p>Long Back Cushion</p>	<p>High L-Shaped Feet</p>
<p>(K) × 4</p> 	<p>Instructions × 1</p> 	<p>(SSB) × 1</p> 
<p>U-Shaped Connector</p>	<p>Instructions</p>	<p>Screw Set B</p>





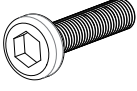
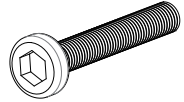
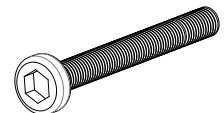
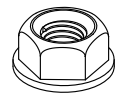
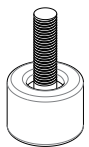
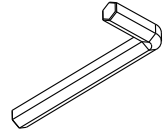
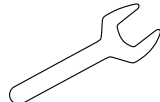
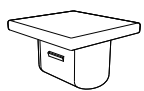

Screw Set B

Middle Sofa's Screw × 2

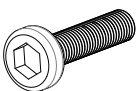
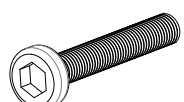
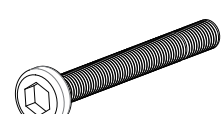
<p>Ⓢ × 3</p>  <p>Bolt M6×35</p>	<p>Ⓚ × 4</p>  <p>Bolt M6×50</p>	<p>Ⓣ × 8</p>  <p>Bolt M6×60</p>	<p>Ⓡ × 12</p>  <p>Washer Nut</p>
<p>Ⓟ × 4</p>  <p>Adjustable Screws</p>	<p>Ⓦ × 1</p>  <p>Spanner</p>	<p>Ⓥ × 1</p>  <p>Wrench</p>	<p>Ⓞ × 3</p>  <p>Aperture Cover</p>

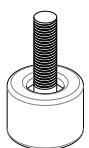
Additional Screws-B

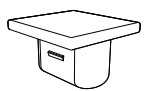
<p>Ⓢ × 2</p>  <p>Bolt M6×35</p>	<p>Ⓚ × 2</p>  <p>Bolt M6×50</p>	<p>Ⓣ × 2</p>  <p>Bolt M6×60</p>	<p>Ⓡ × 2</p>  <p>Washer Nut</p>
<p>Ⓟ × 1</p>  <p>Adjustable Screws</p>	<p>Ⓨ × 1</p>  <p>Restoration of rattan</p>	<p>Ⓩ × 1</p>  <p>Velcro</p>	<p>Ⓞ × 1</p>  <p>Aperture Cover</p>





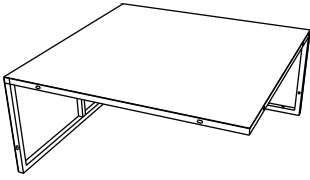
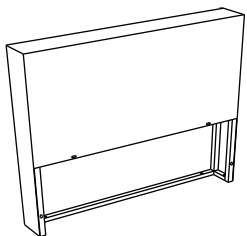
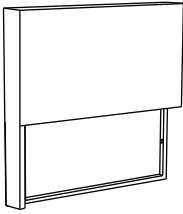
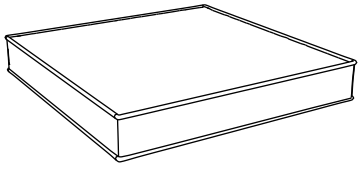
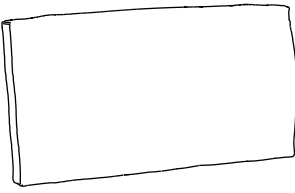
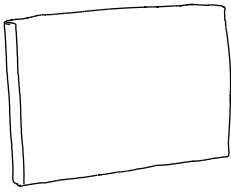
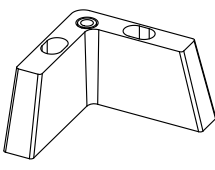
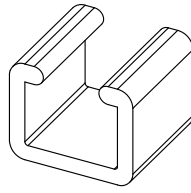
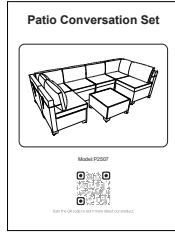
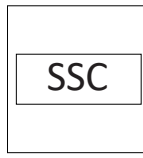

List of Parts in Box C

<p>(A) × 2</p> 	<p>(D) × 2</p> 	<p>(E) × 2</p> 
Sofa Seat Part	Corner Sofa Long Back Part	Corner Sofa Short Back Part
<p>(SC) × 2</p> 	<p>(PL) × 2</p> 	<p>(PS) × 2</p> 
Seat Cushion	Long Back Cushion	Short Back Cushion
<p>(J) × 8</p> 	<p>(K) × 4</p> 	<p>Instructions × 1</p> 
High L-Shaped Feet	U-Shaped Connector	Instructions
<p>(SSC) × 1</p> 		
Screw Set C		



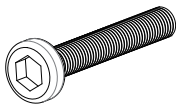
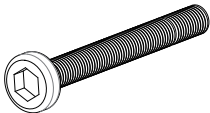

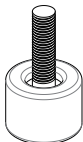
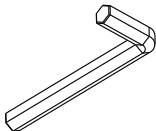
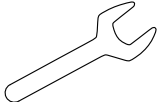

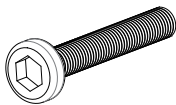
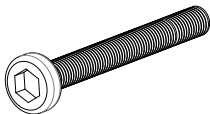

Screw Set C

Corner Sofa's Screw × 2

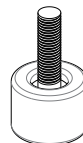
<p>Ⓚ × 8</p>  <p>Bolt M6×50</p>	<p>Ⓣ × 8</p>  <p>Bolt M6×60</p>	<p>Ⓡ × 16</p>  <p>Washer Nut</p>	<p>Ⓟ × 4</p>  <p>Adjustable Screws</p>
<p>Ⓦ × 1</p>  <p>Spanner</p>	<p>Ⓥ × 1</p>  <p>Wrench</p>	<p>Ⓞ × 1</p>  <p>Aperture Cover</p>	

Additional Screws-C

<p>Ⓚ × 2</p>  <p>Bolt M6×50</p>	<p>Ⓣ × 2</p>  <p>Bolt M6×60</p>	<p>Ⓡ × 2</p>  <p>Washer Nut</p>	<p>Ⓟ × 1</p>  <p>Adjustable Screws</p>
<p>Ⓨ × 1</p>  <p>Restoration of rattan</p>	<p>Ⓩ × 1</p>  <p>Velcro</p>	<p>Ⓞ × 1</p>  <p>Aperture Cover</p>	

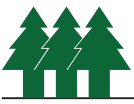

Step 1

Assemble the Middle Sofa Back Part (B) and the Sofa Seat Part (A) using the bolts (Q) and the nuts (R).
NOTE:Don't tighten it.

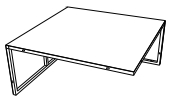
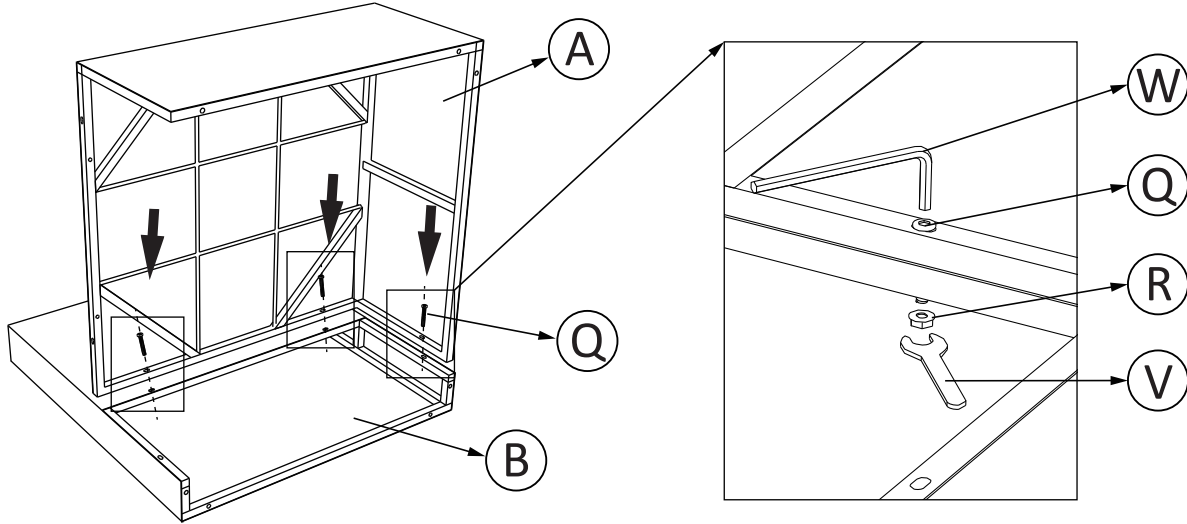

(A) × 1

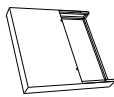

(B) × 1



Bolt M6×50

(Q) × 3



(R) × 3

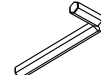

(W) × 1



(V) × 1

Step 2

Assemble the Sofa Side Part (C) by aligning the holes using the bolts (Q) and nuts (R).
NOTE:Don't tighten it.

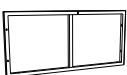
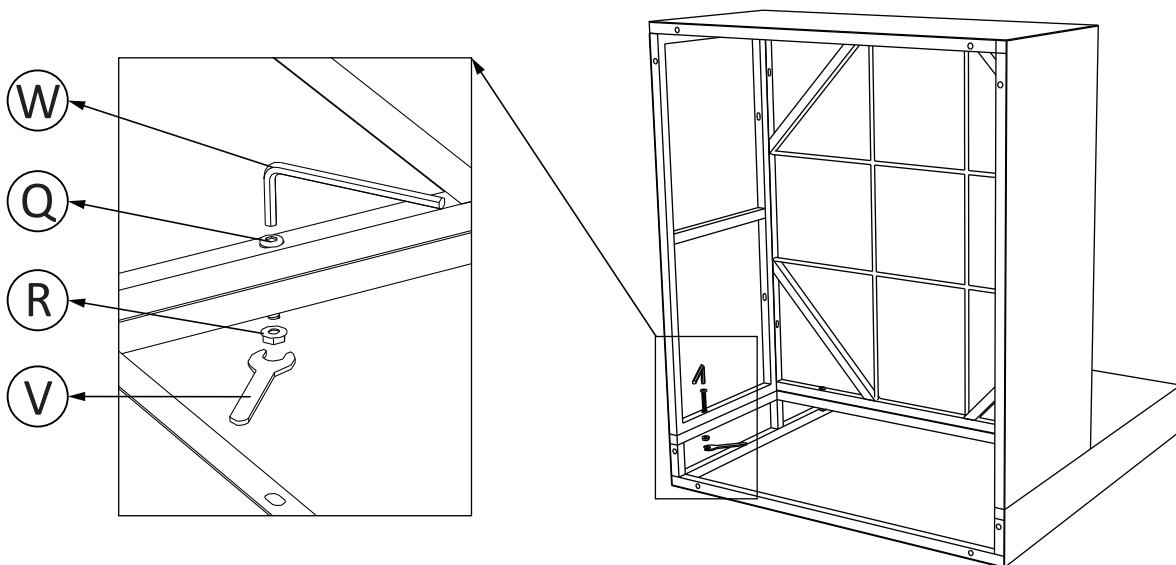

(C) × 1



Bolt M6×50

(Q) × 1



(R) × 1



(W) × 1



(V) × 1

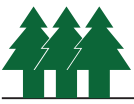

Step 3

Continue assembling the remaining holes in the Sofa Side Part (C) using the bolts (S).

NOTE:Please tighten all bolts.

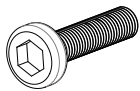
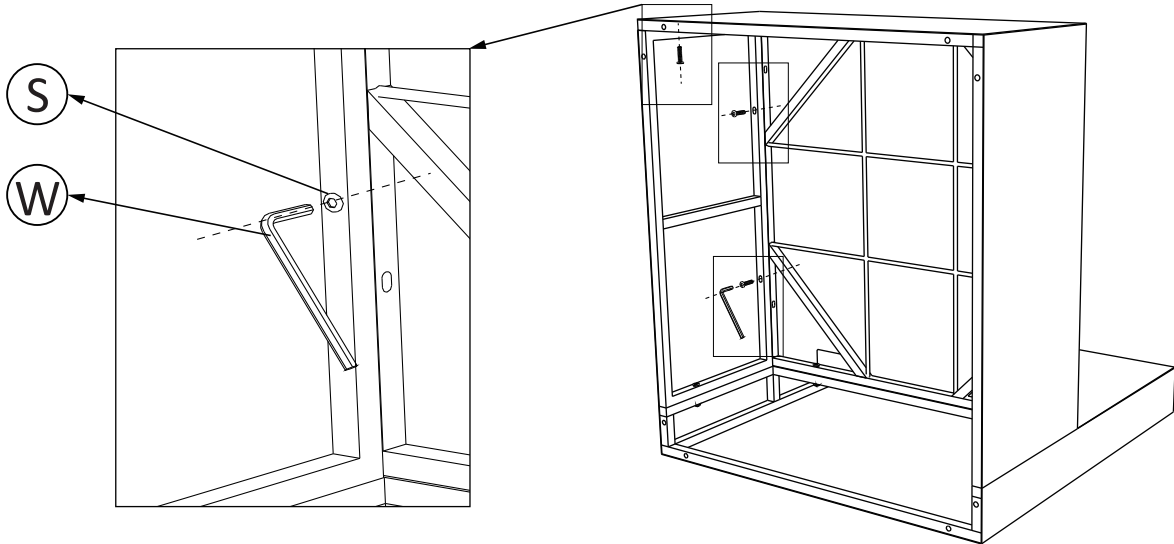

Bolt M6x35

(S) × 3

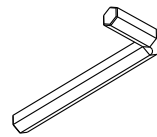

(W) × 1

Step 4

Assemble the High L-Shaped Feet (J) around the bottom of the sofa using the bolts (T) and nuts (P) and screw the adjusting screws (P) into (J).

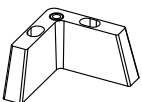
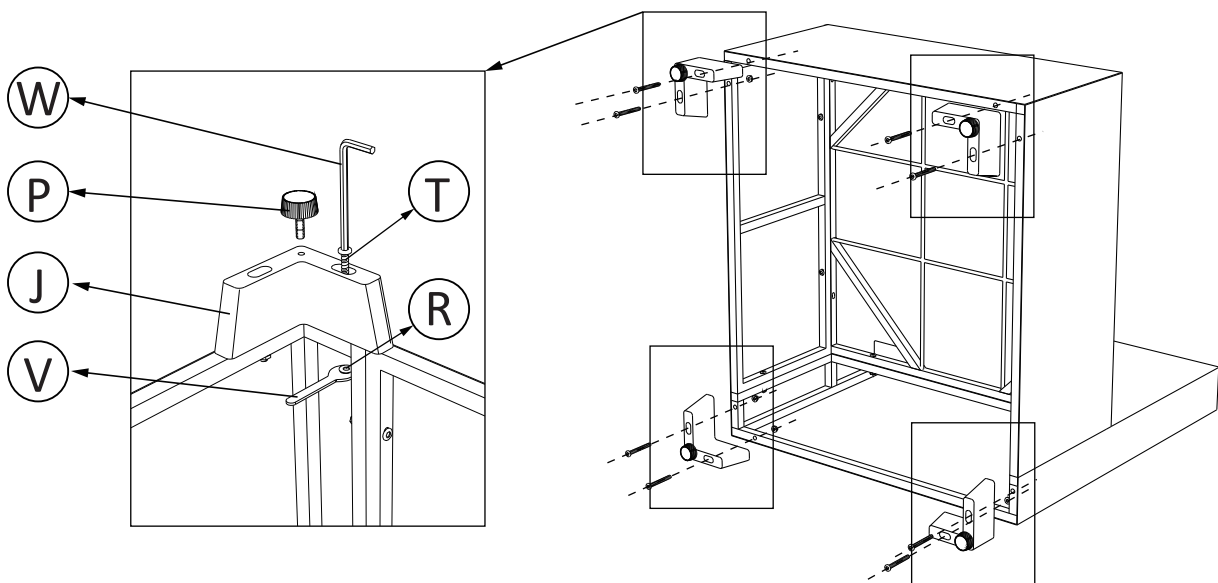

(J) × 4

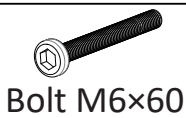

Bolt M6x60

(T) × 8

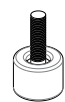

(P) × 4

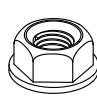

(R) × 8

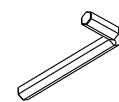

(W) × 1

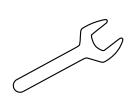

(V) × 1

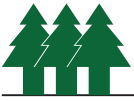

Step 5

Velcro the underside of the Seat Cushion (SC) to the Seat Part velcro and fasten the Long Back Cushion (PL) to the backrest with a tie-down cord.

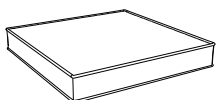
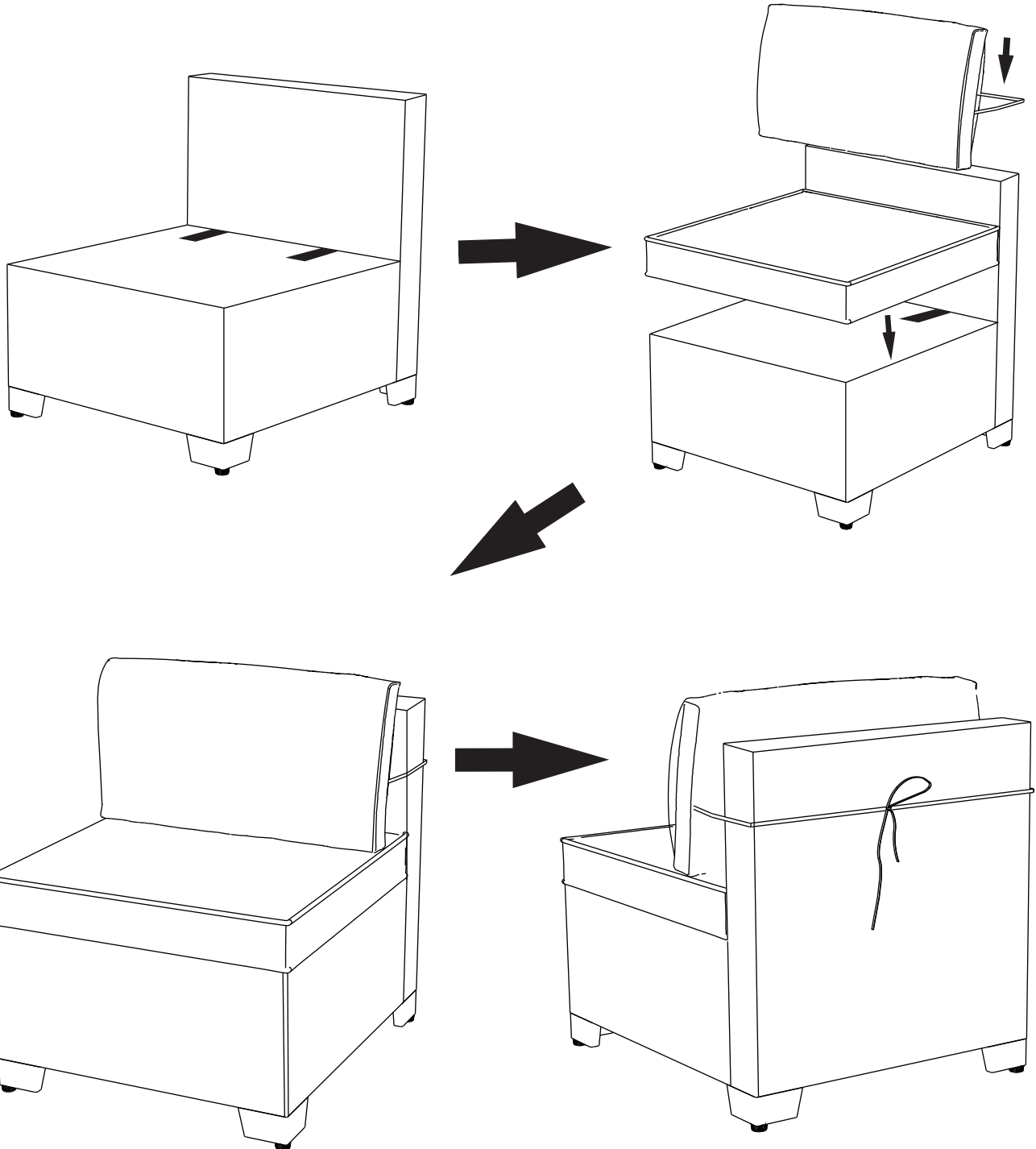

ⓈC × 1



ⓅL × 1

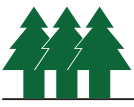

Step 1

Assemble the Corner Short Sofa Back Part (E) and the Sofa Seat Part (A) using the bolts (Q) and the nuts (R).
NOTE:Don't tighten it.

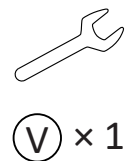
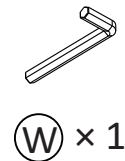
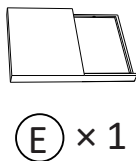
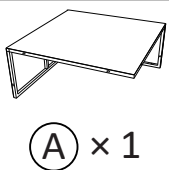
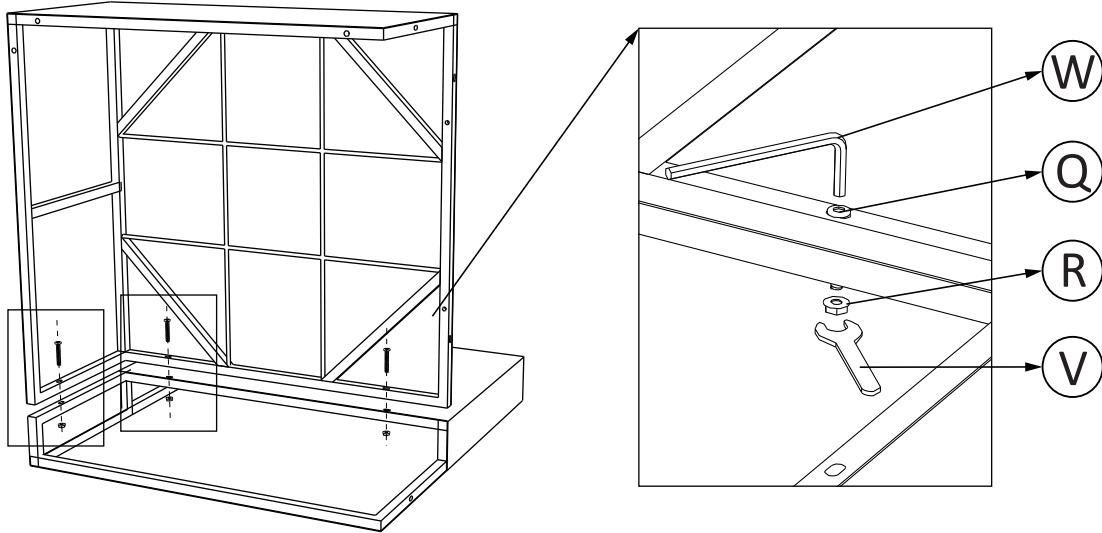

Step 2

Assemble the Corner Long Sofa Back Part (D) and the Sofa Seat Part (A) using the bolts (Q) and the nuts (R). Back (E) and (D) also have a hole on the inside.
NOTE:Please tighten all bolts.

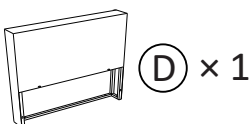
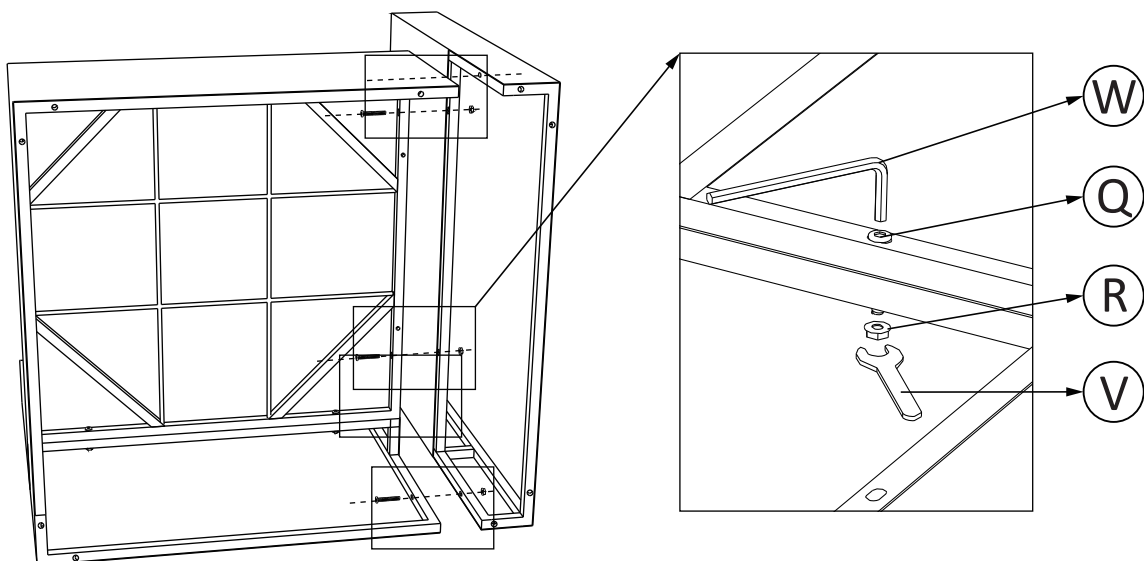



Step 3

Assemble the High L-Shaped Feet (J) around the bottom of the sofa using the bolts (T) and nuts (P) and screw the adjusting screws (W) into (J).

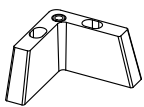
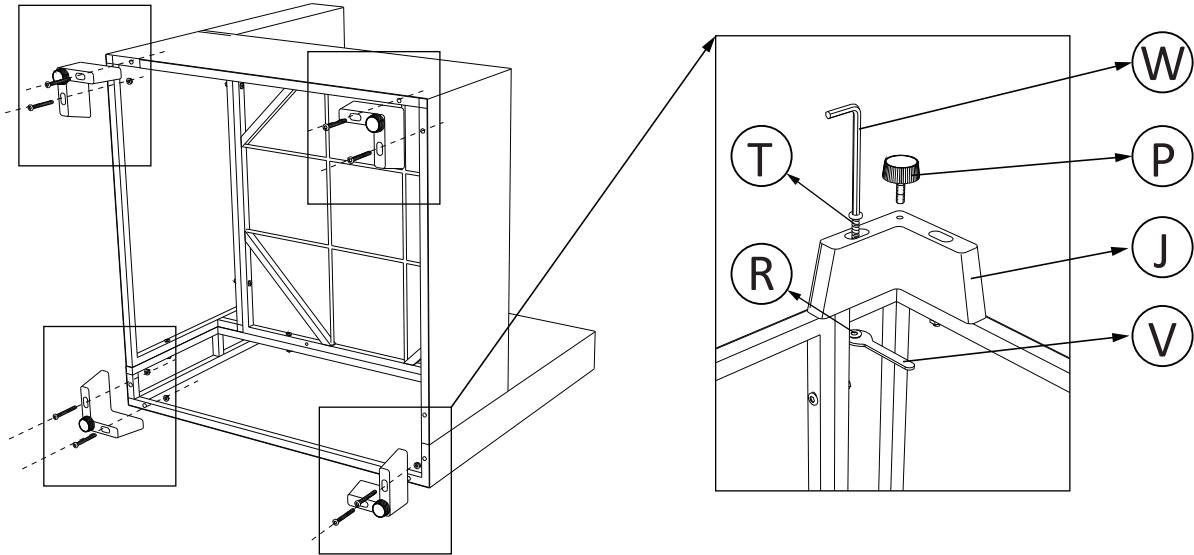

(J) × 4



Bolt M6×60

(T) × 8



(P) × 4



(R) × 8

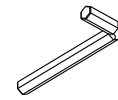

(W) × 1

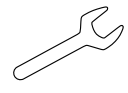

(V) × 1

Step 4

Velcro the underside of the Seat Cushion (SC) to the Seat Part velcro and fasten the Long Back Cushion (PL) and the Short Back Cushion (PS) to the backrest with a tie-down cord.

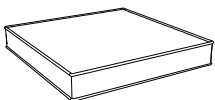
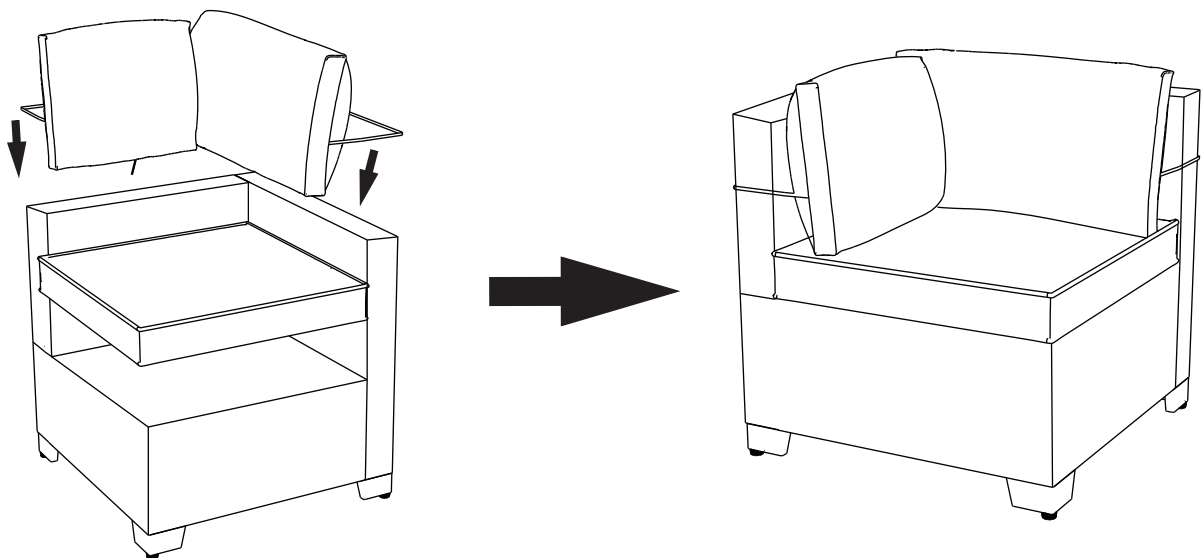

(SC) × 1

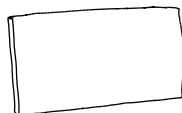

(PL) × 1



(PS) × 1



Step 1

Assemble the two Coffee Table Side Parts(F) with bolts (S).
NOTE:Don't tighten it.

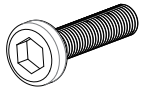
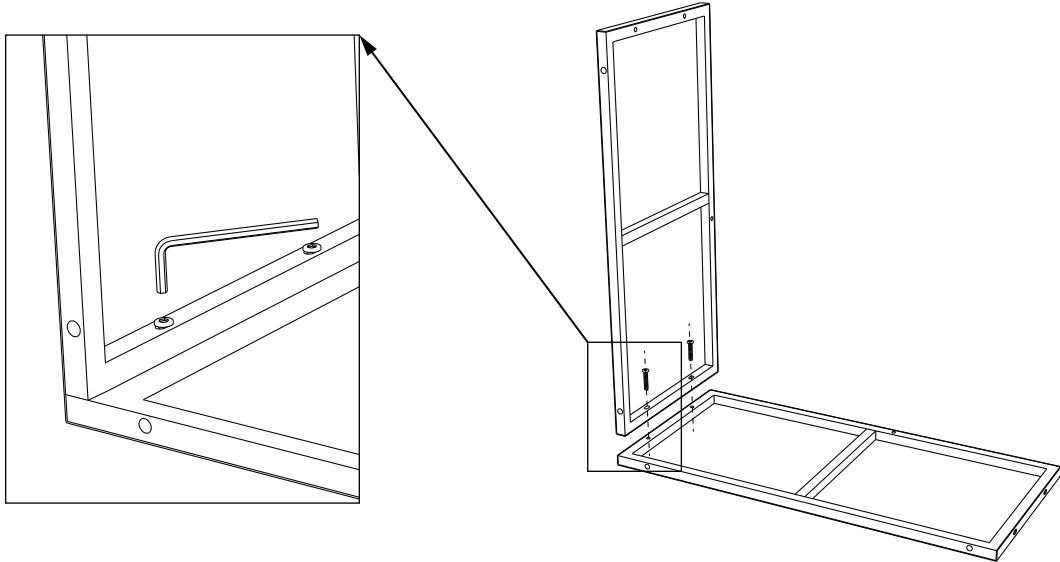

Bolt M6×35

(S) × 2

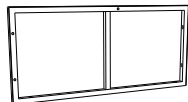

(F) × 2

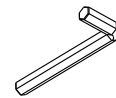

(W) × 1

Step 2

Insert the Coffee Table Connector (H) into the mounted two Side Parts.

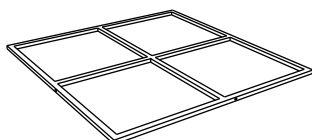
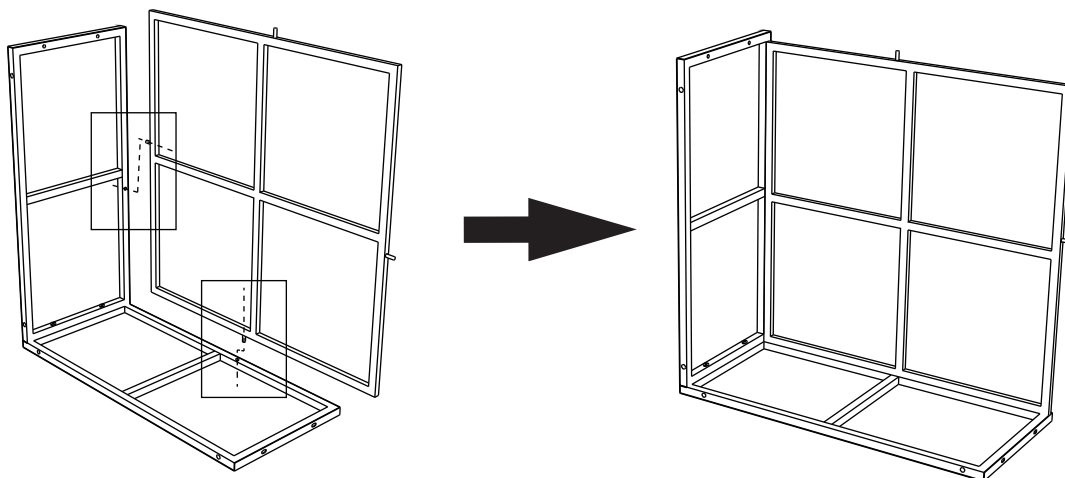

(H) × 1

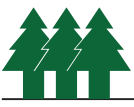

Step 3

Assemble one side Coffee Table Side Part (F) using bolt (S).
NOTE:Don't tighten it.

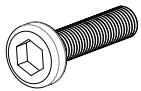
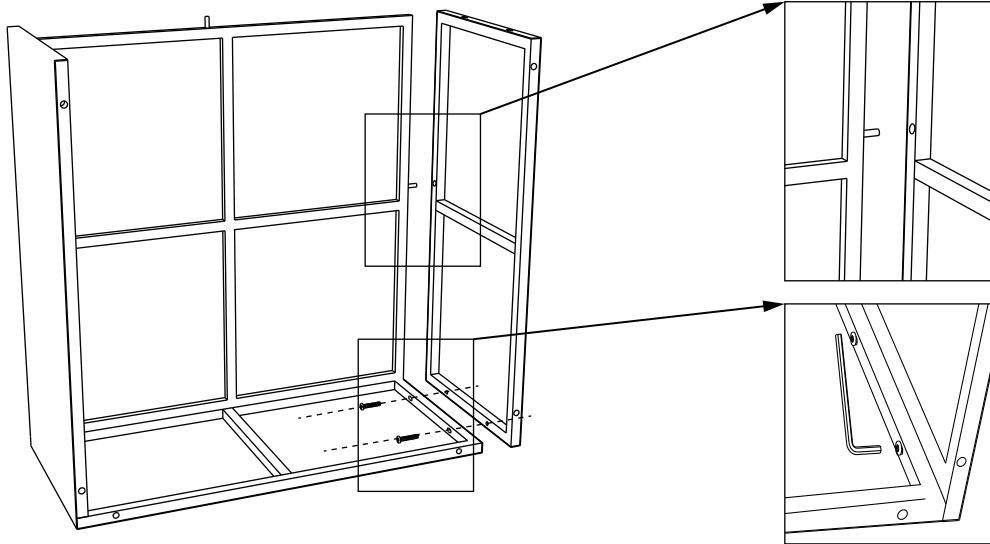

Bolt M6x35

(S) × 2

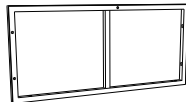

(F) × 1

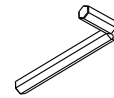

(W) × 1

Step 4

Assemble one side Coffee Table Side Part (F) using bolt (S).
NOTE:Please tighten all bolts.

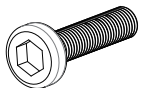
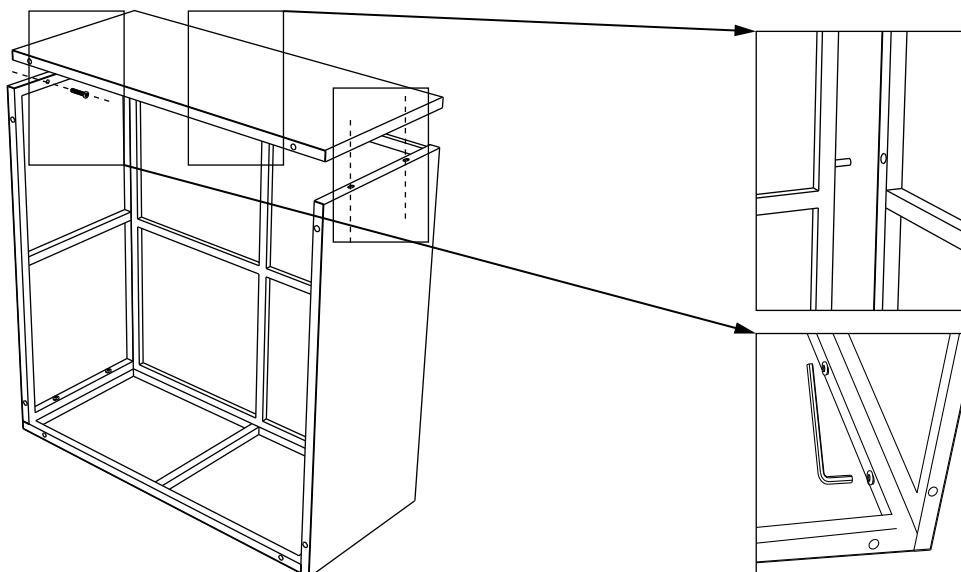

Bolt M6x35

(S) × 4

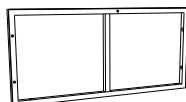

(F) × 1

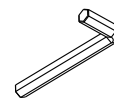

(W) × 1



Step 5

Assemble the High L-Shaped Feet (J) around the bottom of the coffee table using the bolts (T) and nuts (P) and screw the adjusting screws (P) into (J).

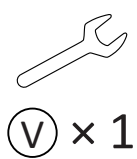
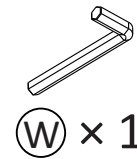
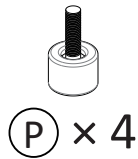
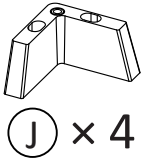
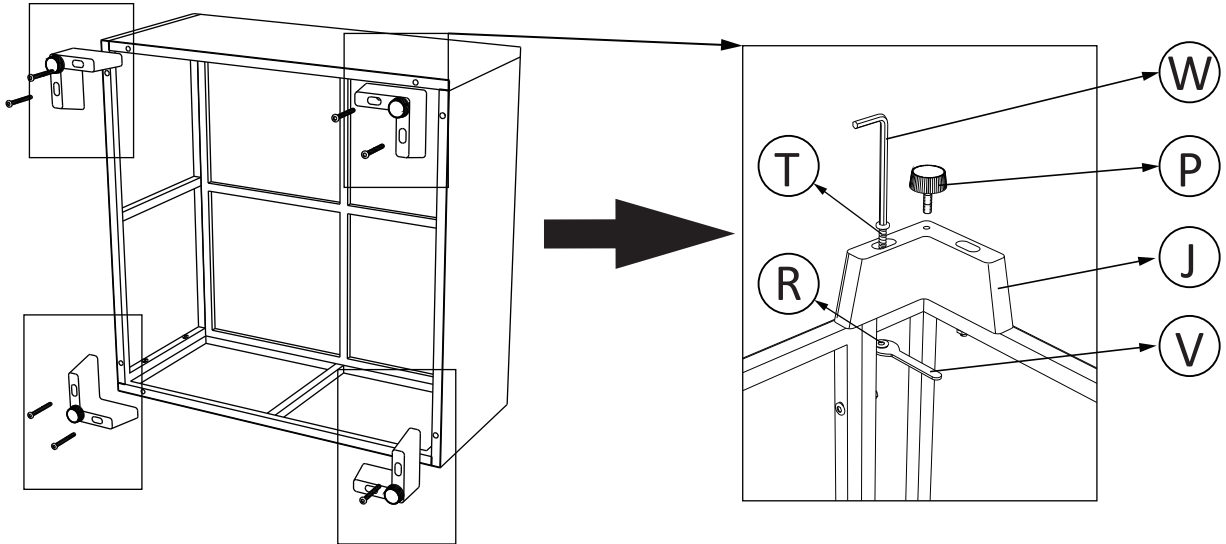

Step 6

Install the Glass Mat (X) in the upper hole of the Coffee Table Connection (H).

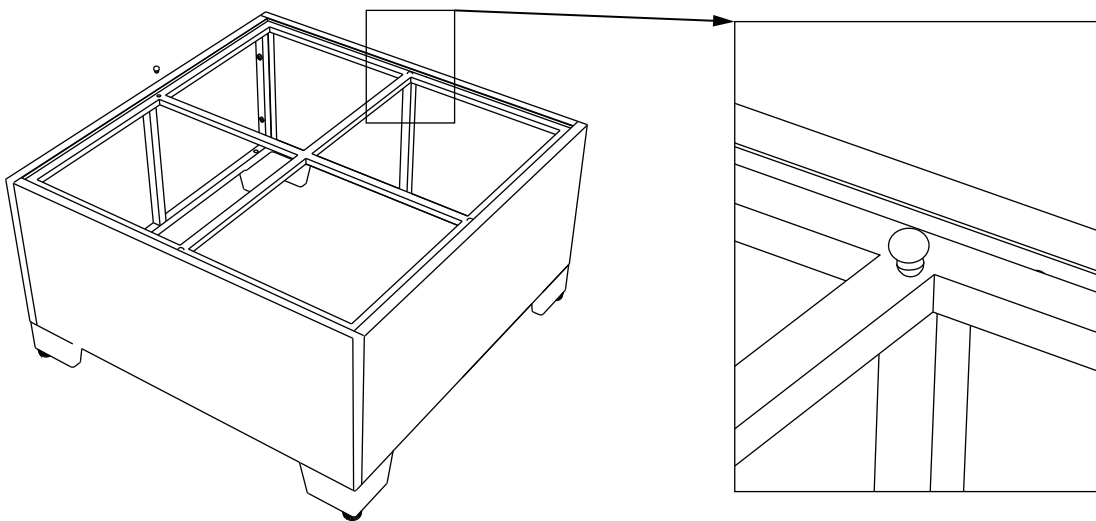

(X) × 4



Step 7

Finally, place the Coffee Table Glass (G) on the Coffee Table Connection (H).

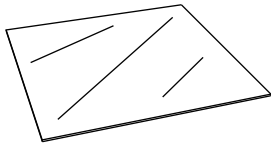
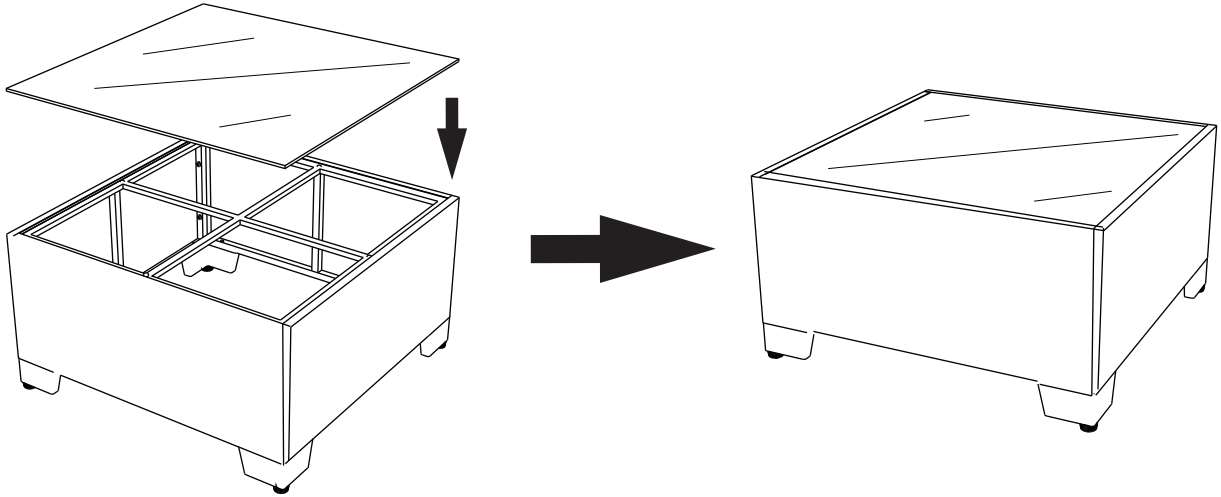

ⓐ × 1

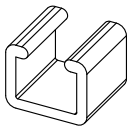

U-shapped connector instructions

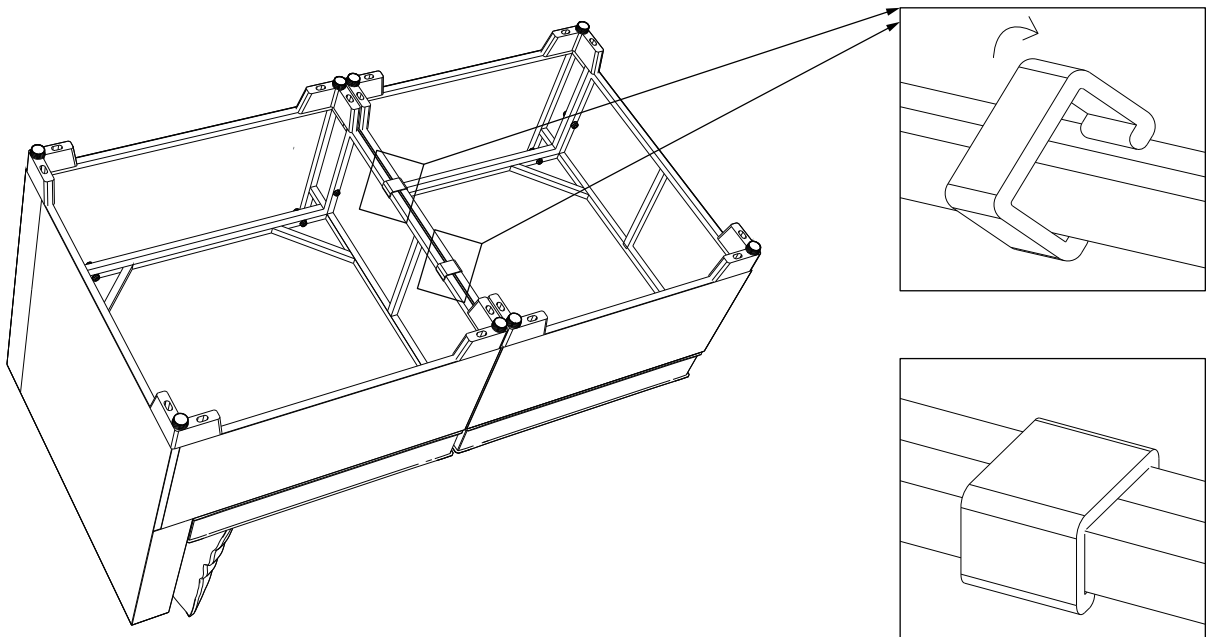



Sofa cover washing instruction



Back pillow



Take the back insert out of the fabric cover



Wash the cloth cover after removing it



Seat Cushion



Take the cushion insert out of the fabric cover

Maintenance and Care

Cleaning

For the rattan frame, use a damp cloth to clean off dust, dirt, or stains. Avoid using harsh chemicals, abrasive cleaners, or scrubbers.

For the cushions and pillows, follow the care instructions on the covers. Wash removable covers in cold water, and for non-removable covers, spot clean with mild soap and water.

Storage

If the sofa set is not in use for extended periods, cover the furniture or store it indoors in a dry, cool location to prevent damage from weather or dirt.

Inspection:

Regularly check the furniture for any loose parts, wear, or damage. Tighten screws and bolts as needed, and replace any damaged components promptly.

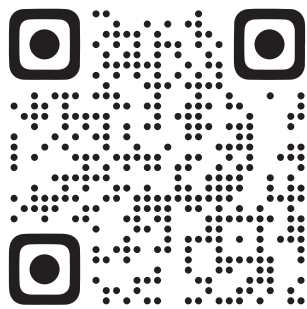

Scan the QR code to learn more about our product.