

Assembly Instructions

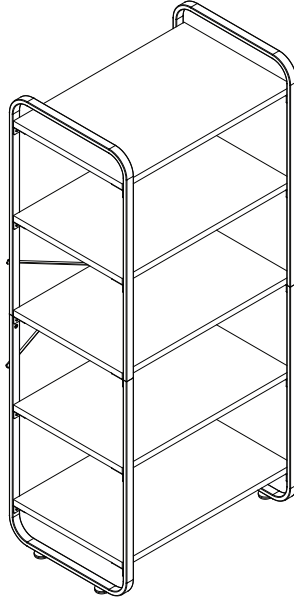

5 Tier Bookcase



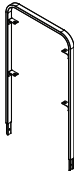
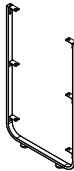

NOTE TO CUSTOMERS:

1. For ease and speed of assembly we recommended that before you commence each step of the assembly that you identify all the parts required to complete that step.
2. We recommended that where possible you allow sufficient space to assemble the item as close as possible to the place where it will be once assembled.
3. For the protection of your furniture we recommended that the product is placed on a protected surface during assembly to prevent any damage.
4. During assembly do not over-tighten, as this may damage the product.
5. Please ensure you retain all the product packaging until the item is completely assembled.
6. Please periodically check all fittings and re-tighten as necessary.
7. It is recommended that this item should be assembled by two adults.

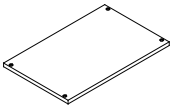
Parts list:

	Upper Frame	Lower Frame	Connecting Bar	Shelf Panel
	A	B	C	D
				
	2PCS	2PCS	1PC	5PCS

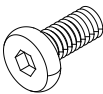
Hardware list:

	Bolt	Bolt	Leveler
	1	2	3
			
	24PCS	4PCS	4PCS

Tool Required:

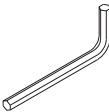
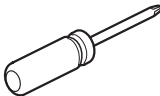
	
⊕ Allen Wrench	⊕ Screwdriver (Not included)

Assembly Instructions

- 1** Attach Levelers (3) to the bottom of Lower Frames (B).

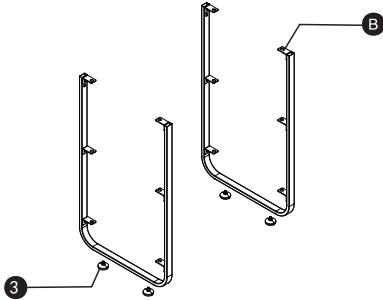

- 2** Tighten and Insert Upper Frames(A) into Lower Frames (B) using Bolts(2).

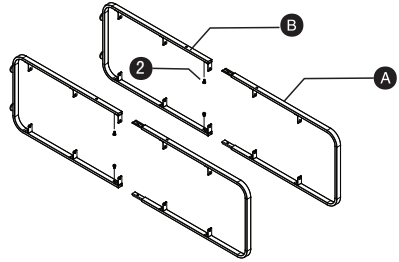

- 3** Attach Connecting Bars (C) to the back of Lower Frames (B) and Upper Frames (A) using Bolts(1) as shown below.
Note: Do not tighten Bolts(1) until Step 4.

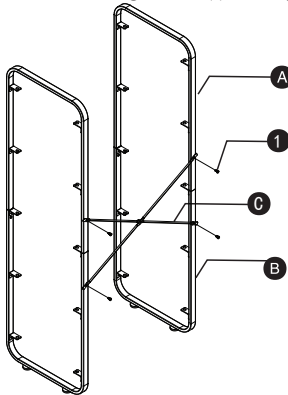

- 4** Attach Shelf Panels (D) to Lower Frames (B) and Upper Frames (A) using Bolts(1) as shown below.
Note: Do not tighten Bolts(1) until all panels are attached.

