

PARTS LIST

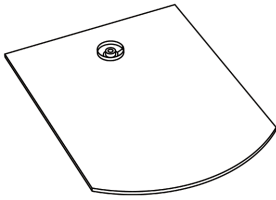

A x 1

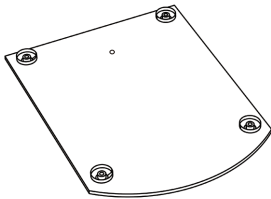

B x 1



C x 1



D x 1

ACCESSORIES LIST



8x38mm

E x 1



8x18mm

F x 1



8x18mm

G x 1



M8

H x 1

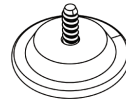

M8xΦ50mm

I x 4

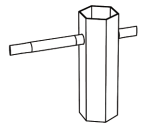

M8

J x 1

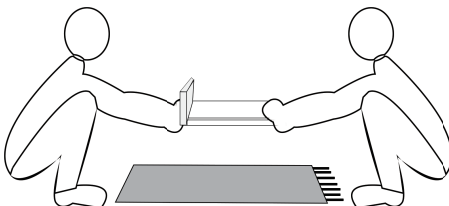

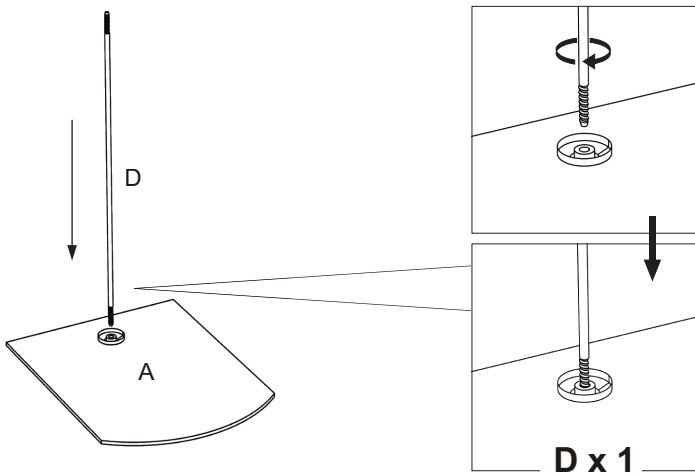
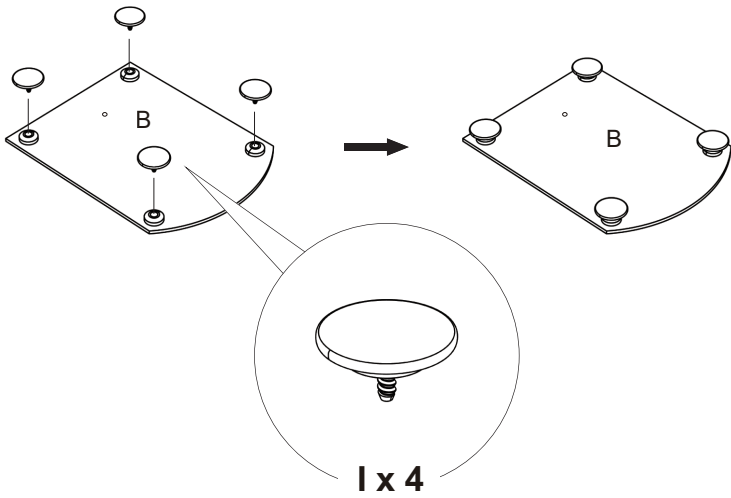

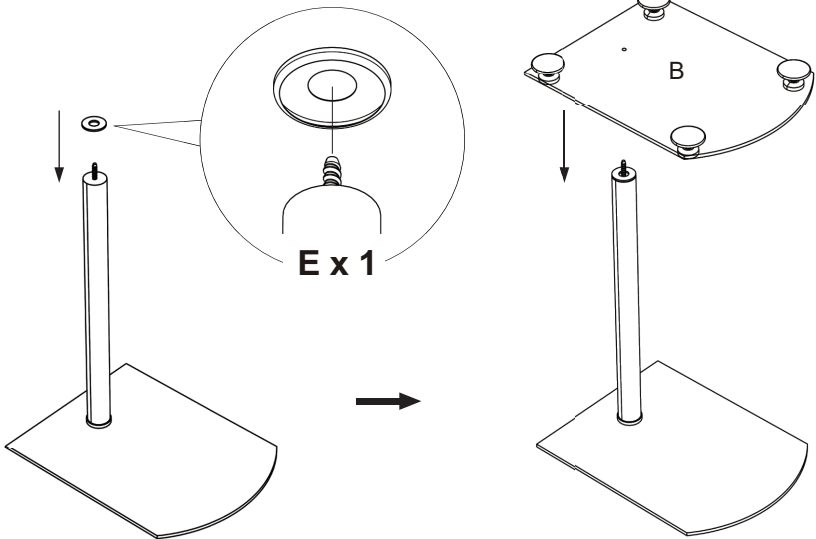
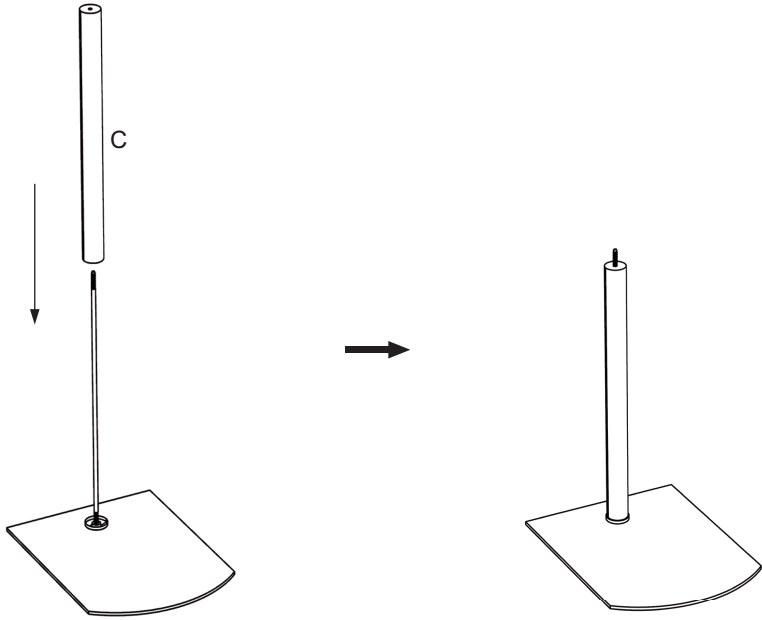

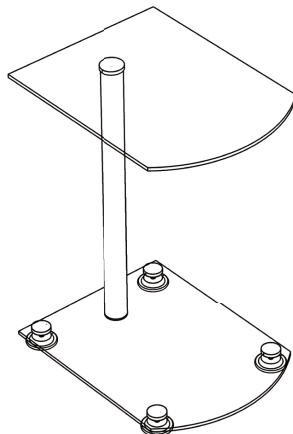
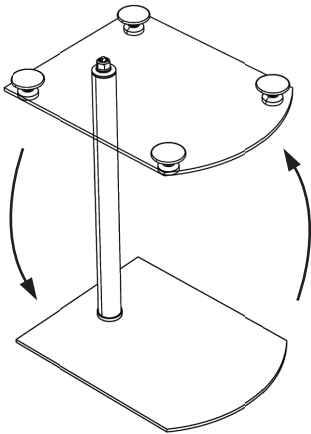
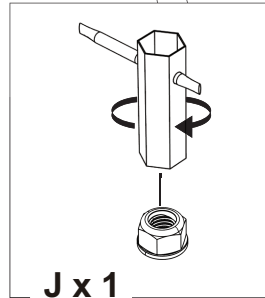
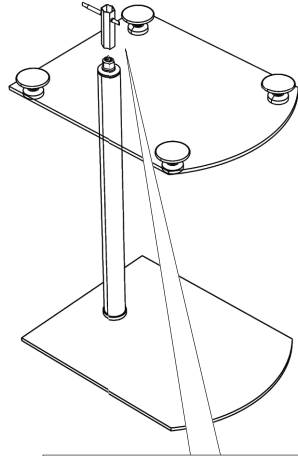
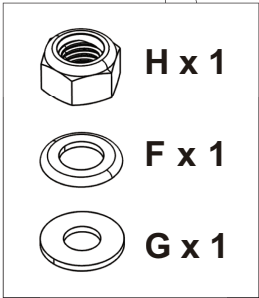
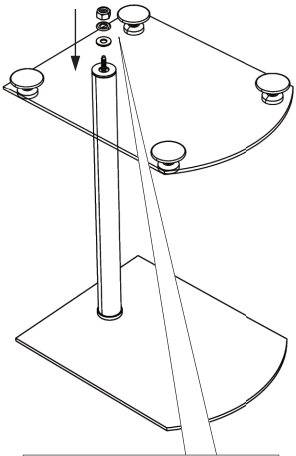

NOTICE

EN

1. Please do not exceed the weight limits of this item.
2. Firmly secure all bolts, screws and knobs before use.
3. Reconfirm that all bolts, screws and knobs are secure after every 90 days.
4. Fasten screws loosely during initial assembly. Do not tighten the screws firmly until the item is assembled completely.
5. Do not use or store this item in the proximity of an open flame or flammable chemicals.

FR

1. Veuillez ne pas dépasser le poids recommandé.
2. Veuillez vous assurer que toutes les vis et écrous sont bien serrés avant la première utilisation.
3. Veuillez resserrer régulièrement toutes les vis et écrous pour prolonger la durée de vie du produit.
4. Lors de la première installation, veuillez ne pas serrer complètement les vis et les écrous. Après avoir terminé toutes les étapes d'installation, veuillez serrer toutes les vis et écrous uniformément.
5. N'utilisez pas le produit à proximité de flammes nues ou de matériaux inflammables.

DE

1. Bitte überschreiten Sie nicht das empfohlene Gewicht.
2. Bitte stellen Sie vor dem ersten Gebrauch sicher, dass alle Schrauben und Muttern fest angezogen sind.
3. Ziehen Sie alle Schrauben und Muttern regelmäßig wieder an, um die Lebensdauer des Produkts zu verlängern.
4. Bitte ziehen Sie die Schrauben und Muttern während der Erstinstallation nicht vollständig an. Ziehen Sie nach Abschluss aller Installationsschritte alle Schrauben und Muttern gleichmäßig an.
5. Verwenden Sie das Produkt nicht in der Nähe von offenen Flammen oder brennbaren Materialien.

NOTICE

ES

1. No utilice más del peso recomendado.
2. Asegúrese de que todos los tornillos y tuercas estén completamente apretados antes del uso inicial.
3. Vuelva a apretar todos los tornillos y tuercas regularmente para prolongar la vida útil del producto.
4. No apriete completamente los tornillos y tuercas durante la instalación inicial, y apriete todos los tornillos y tuercas uniformemente después de que se completen todos los pasos de instalación.
5. No utilice el producto cerca de llamas abiertas o materiales inflamables.

IT

1. Si prega di non superare il peso consigliato.
2. Assicurarsi che viti e dadi (tutti) siano completamente serrati prima dell'utilizzo.
3. Verificare regolarmente (ogni 90 giorni) che viti e dadi siano ben serrati.
4. Si prega di non serrare completamente viti e dadi durante l'installazione iniziale. Solamente dopo aver completato tutti i passaggi di installazione, serrare viti e dadi in modo uniforme.
5. Non utilizzare il prodotto vicino a fiamme libere o materiali infiammabili.