

OFFICE CHAIR  
USER MANUAL

# NOUHAUS ERGONOMIC OFFICE CHAIR USER MANUAL

N20



# NOUHAUS ERGONOMIC OFFICE CHAIR USER MANUAL



Thank you for purchasing the NOUHAUS Ergonomic Office Chair.  
Please read this manual carefully before using.  
Retain this manual for your reference.

This user manual contains the product warranty information.  
The design and/or specification of this product is subject to change without notice.

## CONTENTS

<b>01</b>	Instructions on Safe Use	Pg 05
<b>02</b>	Assembly Parts	Pg 06
<b>03</b>	How to Assemble	Pg 07
<b>04</b>	How to Use	Pg 11
<b>05</b>	Product Specifications and Information	Pg 13
<b>06</b>	Customer Service Information	Pg 14
<b>07</b>	Product Warranty	Pg 15

**N20**  
**NO-SN401E**













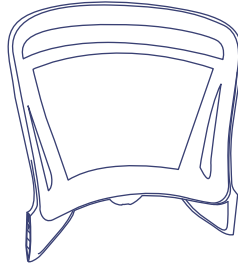

**PLEASE READ**

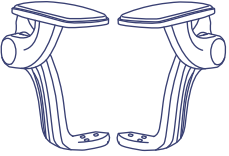
1. Do not discard any of the packaging until you are certain that you have all the necessary parts for the assembly.
2. Please ensure that the packaging is disposed of in a safe and environmentally responsible way.
3. During assembly, tighten screws by hand only. Once all screws are in place, you may tighten all screws completely.

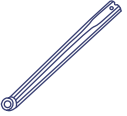
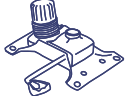

**CAUTION**

1. NEVER use this chair as a step ladder.
2. Check that screws have not become loosened every 6 months. Retighten if necessary.
3. Do not allow children to play with or operate the mechanism.
4. Keep hands and feet clear of the mechanism.
5. Only the occupant should operate mechanism.

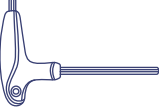
(A) Chair Back x1 		(B) Support x1 	(C) Headrest x1 	
(D) Chair Seat x1 				
(E) Arms Left x1 Right x1 		(F) Chair Base 1 x1 	(G) Chair Base 2 x5 	
(H) Seat Mechanism x1 	(I) Gas Lift x1 	(J) Casters x5 		
(K) x8 	(L) x6 	(M) x5 	(N) x2 	(O) x1  Allen Wrench

\*Extra screws included

**Tools Needed: Allen Wrench - Provided**  
**Please read all instructions before assembly.**

**Step 1**

Insert Chair Base 2 (G) into Chair Base 1 (F) and align it with the holes. Then use the Allen Wrench(O) to tighten the screws(M) to assemble.

**Step 2**

Insert Casters (J) into Chair Base 2 (G). Insert Gas Lift (I) into the hole in the center of the Chair Base 1 (F).

**Step 3**

Separate the Support (B)screw on Chair Back (A).

**Step 4**

Push the Support (B) in Chair Back (A) and Attach the Screw.

**Step 5**

Position the Armrest (E) well into the hole in the chair seat (D) and tighten it with screws (L) to assemble it. Make sure to distinguish between the front and back of the chair seat.

**Step 6**

Attach the Seat Mechanism (H) to the assembled armrest and chair seat and assemble it with screws (K).

**Step 3**

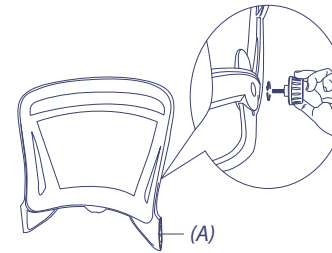

**Step 4**

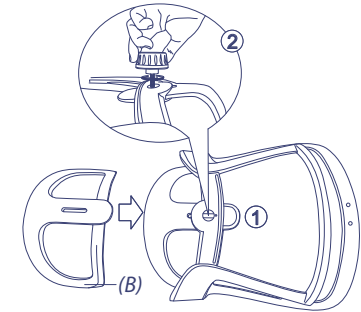

**Step 1**

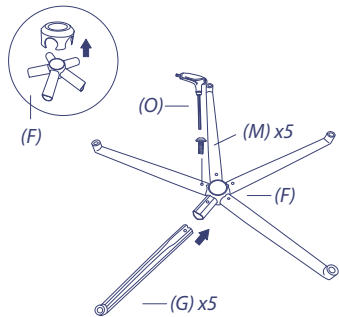

**Step 2**

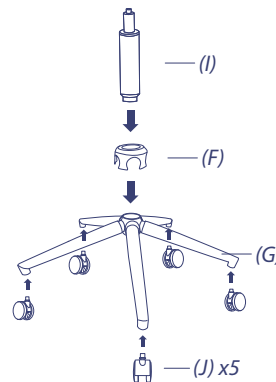

**Step 5**

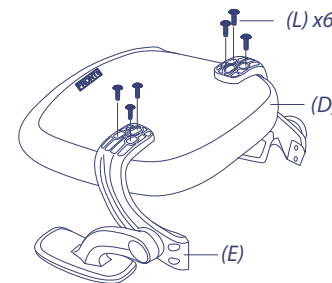

**Step 6**

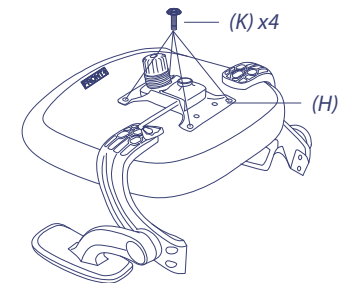

**Step 7**

Attach the Chair Seat (D) and Gas Lift (I).

**Step 8**

Assemble the Armrest (E) and the assembled Chair Back (A) according to the hole.

**Step 9**

Assemble a total of four Screws (K)x2, B1 hole, on the fitted armrest at 50% strength.

**Step 10**

Assemble a total of four Screws (K)x2, B2 hole, on the fitted armrest at 50% strength.

**Step 11**

Turn the Screw (K)x4 and match it to 100% strength.

**Step 12**

Position the Headrest (C) to t into the Chair Back (A) hole and tighten the screw (N) to assemble it.

**Step 7**

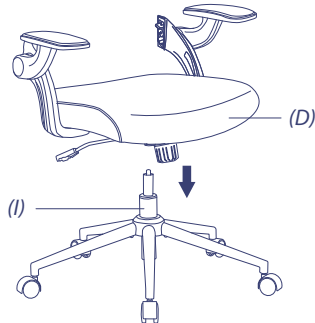

**Step 8**

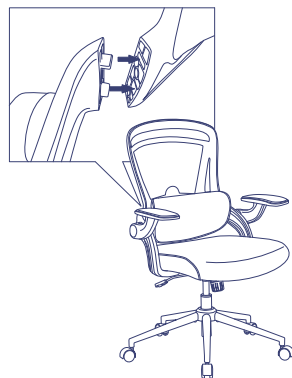

**Step 9**

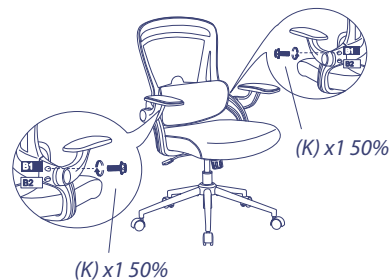

**Step 10**

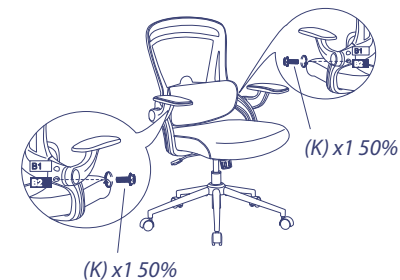

**Step 11**

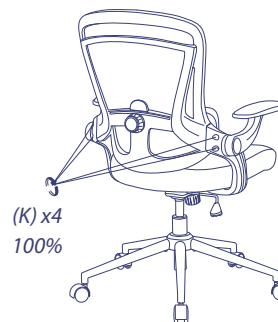

**Step 12**

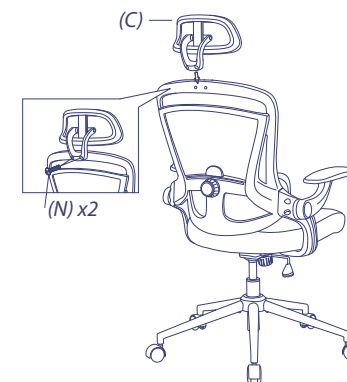

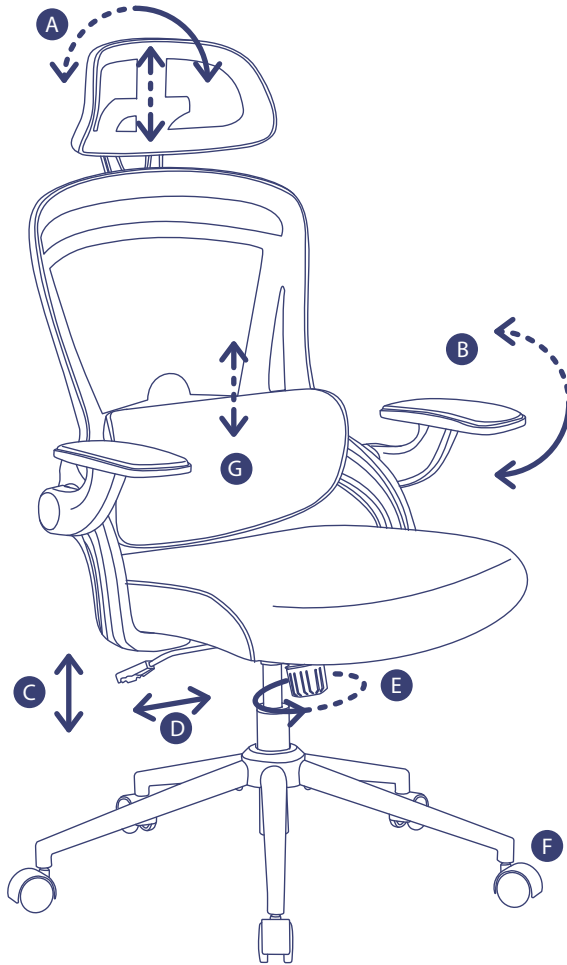
**A HEADREST**

Move the headrest up or down to adjust the height. Angle the headrest upward/downward.

**B FLIP ARMRESTS**

When concentration is required, the armrest can be completely flip back.

**C HEIGHT**

Pull the 'flap' of the handle up to adjust the height of the chair.

**D TILT MECHANISM**

Right handle (while seated): Push inwards/pull outwards to lock/unlock the tilt mechanism. If in the reclined position and the tilt mechanism is unlocked, give the backrest a slight push to release.

\*Three tilt locking positions: upright, middle, and fully reclined.

**E TILT TENSION**

Turn the knob counter-clockwise to loosen the tilt tension of the chair, clockwise to tighten. Adjust according to your own preference.

**F WHEELS**

Caster Wheels: Suitable for carpet, chair mats, and soft floors.

**G RUMBER SUPPORT**

Turn the knob at the backside of chair-clockwise to Lock, counter clockwise to loose. When it loosen you can adjust the height of rumber support.

Product Name	Nouhaus N20
Model Number	NO-SN401E
Chair Dimensions	W72 x D72 x H118~133.5 cm
Seat Depth	45 cm
Max Hip Width	51.5 cm
Net Weight	13.2 kg
Gross Weight	16 kg
Weight Capacity	≤125 kg
Height Capacity	164 - 185 cm
Fabric	Mesh
Wheels	Nylon Wheels
Base	Iron Base

NOUHAUS office chairs are warranted for a period of 1 years against

1. Missing materials from the Product at the time of delivery;
2. Defects in the manufacturing of materials used for the Products at the time of delivery;
3. Failure of the Products to correspond with the description in the applicable contract of sale at the time of delivery; and
4. Major defects in the functional department, such as :
  - a. Skeletal frame failure
  - b. Casters mechanism failure
  - c. Tilt mechanism failure
  - d. Gas lift failure
  - e. Armrest mechanism failure

**Subject to the following:**

Any replacement parts shall be sent to the address of the original purchaser, replaced parts may be required to be shipped back to NOUHAUS at its discretion; to benefit under this warranty, NOUHAUS must be notified of any defect within 14 days of the occurrence of such defect via an image or video of the relevant defect sent electronically to nouhaus@nouhaus.co.kr, and after inspection and acceptance by NOUHAUS; to the extent permitted under the applicable Consumer Dispute Resolution Standard laws of the Fair Trade Commission, all parts replaced or repaired under this warranty shall be warranted for the remainder of the designated Warranty Period.

**What Our Warranty Does Not Cover**

All warranties listed on this page exclude the following where permitted under the applicable Consumer Dispute Resolution Standard laws of the Fair Trade Commission:

1. Excludes normal wear and tear of surfaces that are not attributable to manufacturing, including but not limited to (a) degradation of upholstery (PU leather / fabric / genuine leather / mesh), top portion of armrests, pillows, casters exterior or mesh stitching, (b) damage to plastic coverings, (c) variance of tightness of mechanisms, and (d) excludes damage from accidents, natural disasters, physical damage from pets, fire and flood, and non-manufacturing incidents covered under insurance policies (regardless of whether you are in possession of the relevant insurance), (e) excludes any variations in dimensions and color;
2. Any claims for indirect, consequential or incidental losses.
3. Damage to a product that has been modified or altered without the written permission of NOUHAUS;
4. Damage caused to all NOUHAUS products during self-assembly due to failure to adhere to the relevant self-assembly manual instructions provided;
5. Minor misalignments, variations arising out of hand-made workmanship. To ensure your product enjoyment and safety, and protection under the "Warranty Period", please ensure you have NOUHAUS assembly and care guidelines for this product, and follow them for the correct assembly and care for your item. Contact our Customer Service Team to obtain these guidelines if you do not have them.



For warranty information, please visit the Warranty page at  
[www.nouhaus.co.kr](http://www.nouhaus.co.kr) / [www.nouhaus.com](http://www.nouhaus.com) / [www.nouhaus.cn](http://www.nouhaus.cn)

---

**Product Information**

Product Name	Model Number	NO-SN401E
Manufacture Date . . . .	Manufacture Number	
Purchase Store	Purchase Store Contact	
Date of Purchase . . . .	Order Number	
Date of Installation . . . .	Warranty Date . . . .	

---

**Customer Information**

Name
Contact
Address

**Customer Service Center**

**KOREA**

71, Hoenamu-ro, Yongsan-gu, Seoul, Republic of Korea 04344  
02-3409-9500

**USA**

10985 Oleander Avenue Fontana, CA92337  
+1(888)387-5949

**CHINA**

Room 302, Building 2, 258 Xiqin Street, Wuchang Street,  
Yuhang District, Hangzhou  
400-800-8767