

Tên chi tiết	SL/ SP	Quy cách tính (mm)			KL tính (m ³)
		Dày	Rộng	Dài	
Chân	4	22	60	450	0.00238
Kiêng chân dưới	2	22	40	454	0.00080
Kiêng chân trên	2	22	40	454	0.00080
Kiêng chân dọc	1	22	40	598	0.00053
Đố dọc	2	22	60	580	0.00153
Đố ngang lớn	4	22	60	454	0.00240
Nan mặt	9	22	30	540	0.00321
Nan hông	18	22	38	165	0.00248
Kc góc	4	22	60	60	0.00032
Tổng :	46				0.01444

Drawing Code:	Drawn by: Lihung	Address:	Product Name: Backless bench I	
			Detail:	
Update:	Designed by:	Scale: 1 / 5	Dimension:	Material:
			Checked by:	Sheet Number:

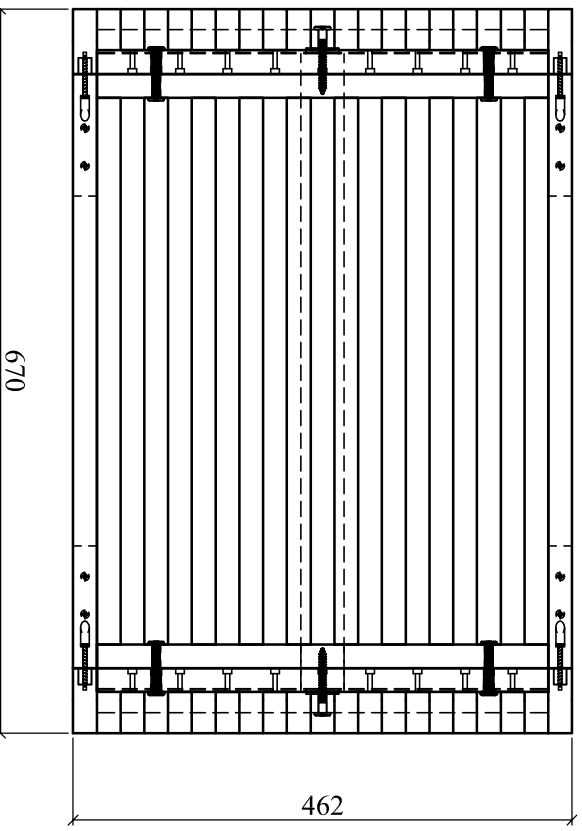

Address:		Product Name: Backless bench I	
Drawing Code:		Detail:	
Update:		Dimension:	
Drawn by: Lihung	Designed by:	Checked by:	Material:
		Scale: 1/7	Sheet Number:

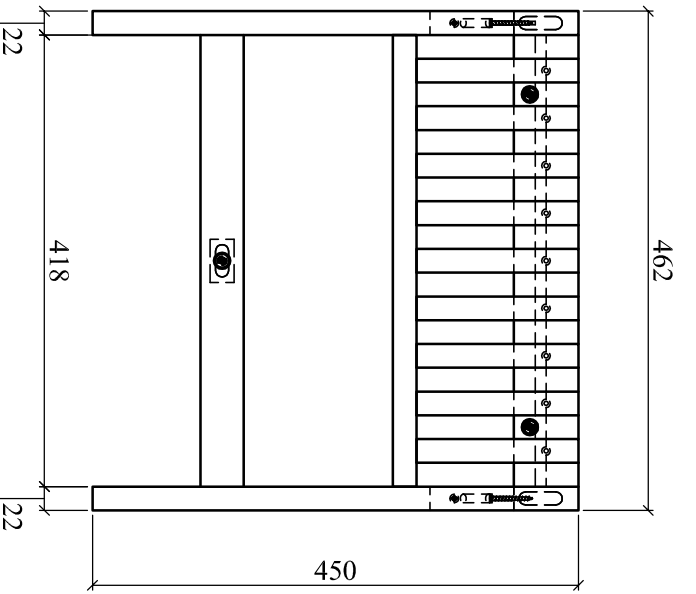
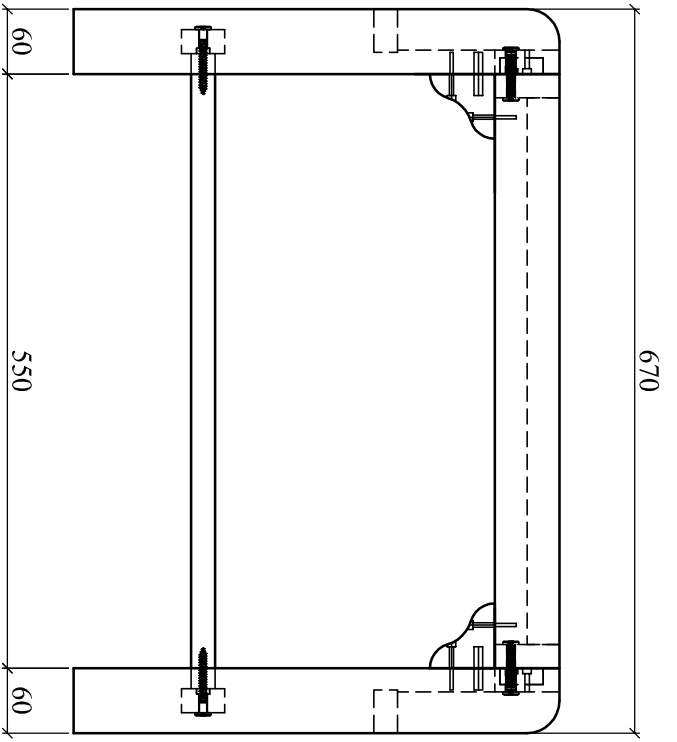
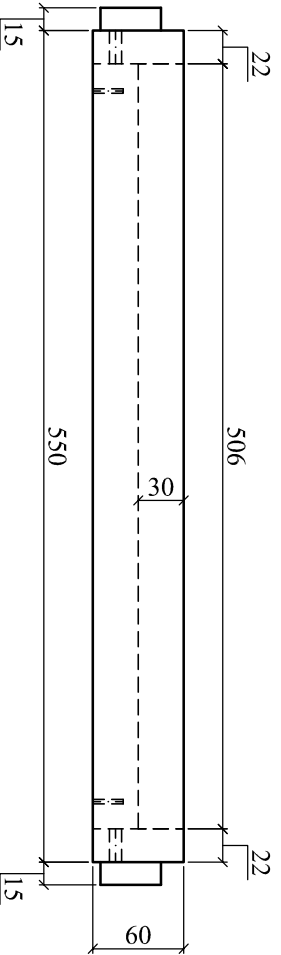
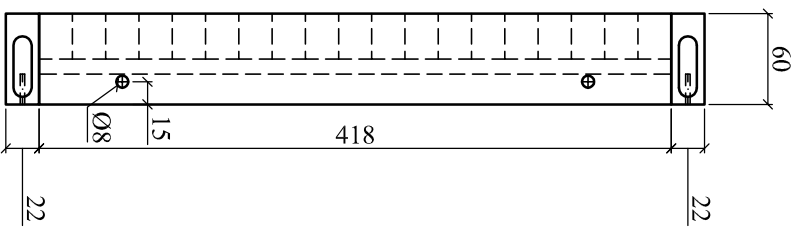
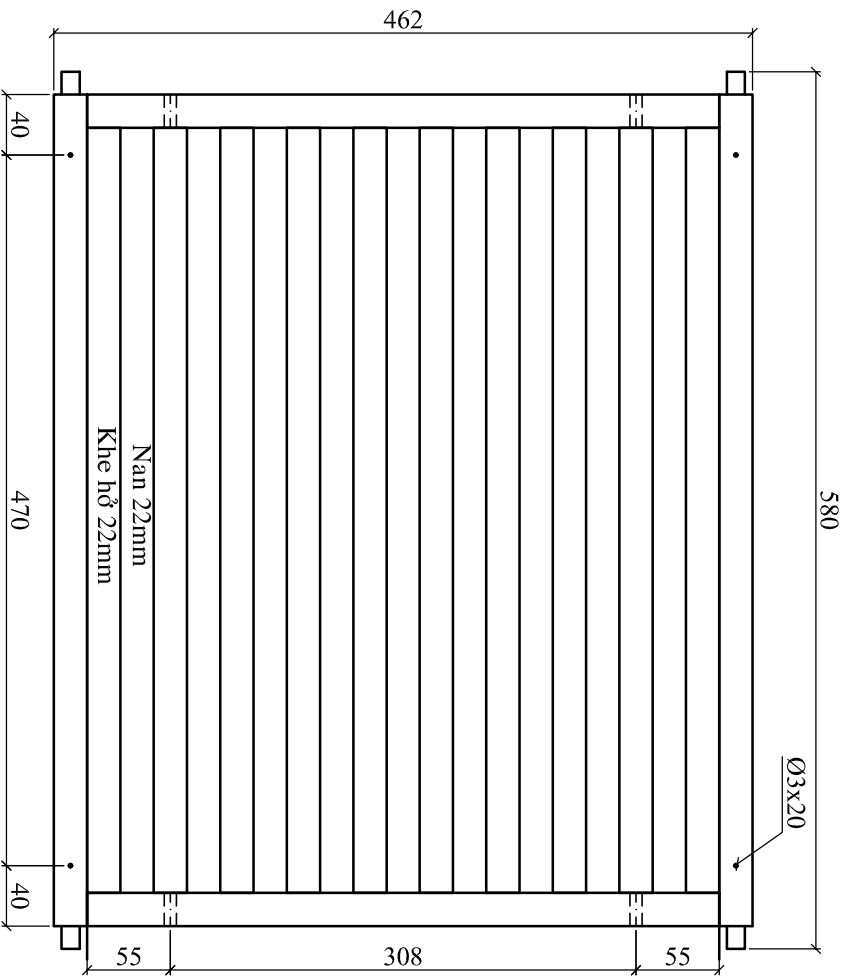

Address:		Product Name: Backless bench I	
Drawing Code:		Detail:	
Drawn by: Lhung		Dimension:	
Designed by:		Checked by:	
Update:		Scale: 1 / 5	
		Material:	
		Sheet Number:	



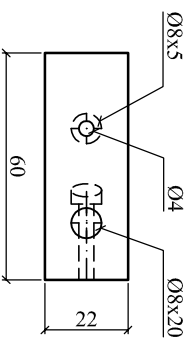
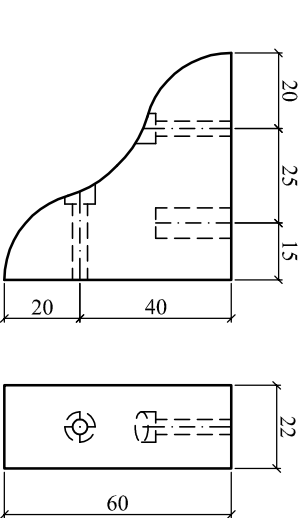
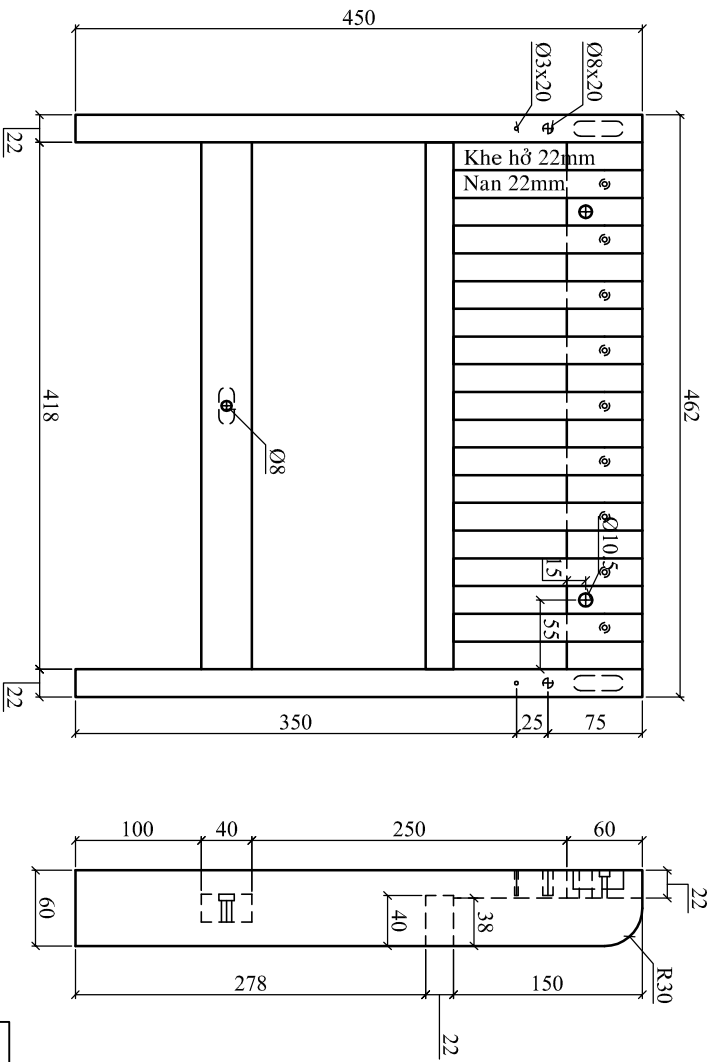
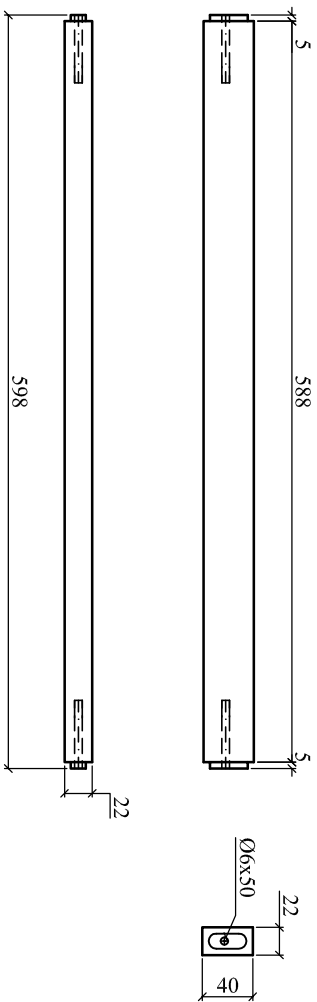

Chú ý : Bỏ R3 cạnh chi tiết



Address:		Product Name: Backless bench I	
Drawing Code:		Detail:	
Drawn by: Linhung		Dimension:	
Designed by:		Checked by:	
Update:		Scale: 1/16	
		Material:	
		Sheet Number:	

Chú ý : Bộ R3 cạnh chi tiết

ASSEMBLY INSTRUCTION

Item	Name	Qty	Description
A	F - bolt 8x40	4	
B	Sleeve nut	4	
C	C - Screw 4x40	8	
D	F - Screw 7x60	2	
E	Allen Key	2	

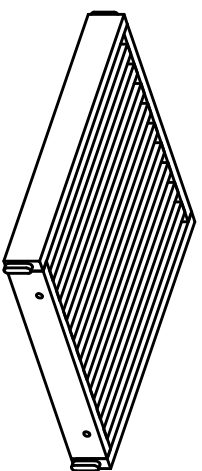

QTY 1

①

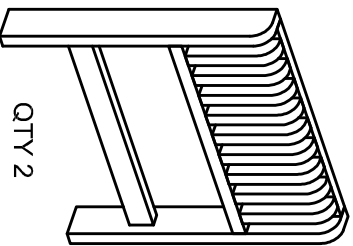

QTY 2

②

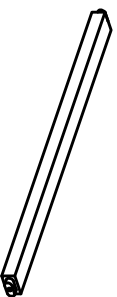

QTY 1

③



QTY 4

④

