

# ASSEMBLY INSTRUCTIONS

## BACK

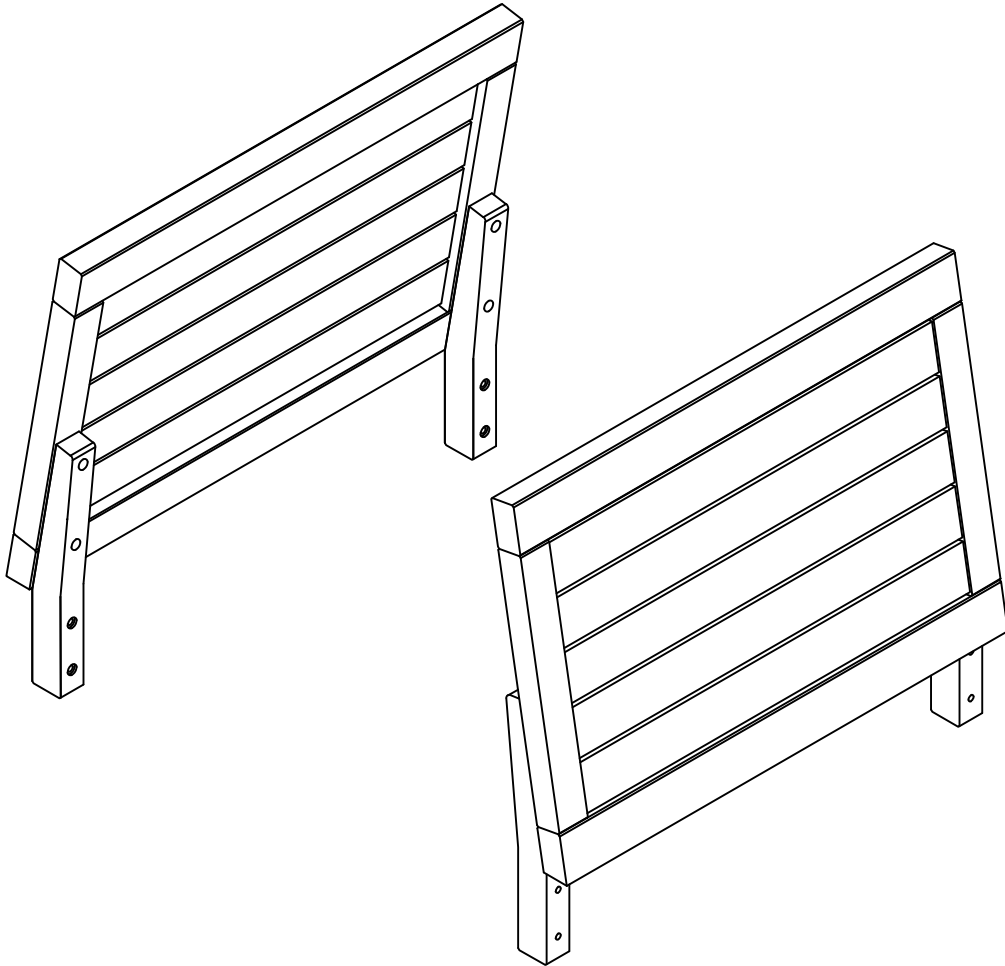

### Tools Required (Not Included)

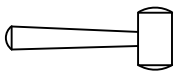

Rubber Hammer

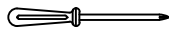

Phillips Screwdriver

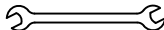

Wrench



Cordless Drive (\*)



(\*) NOTE: Optional - use in place of hex drive.

**Identifying the Hardware**-Identify the hardware using the illustrations below.

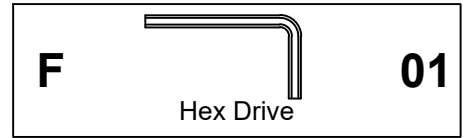
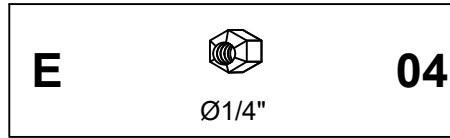
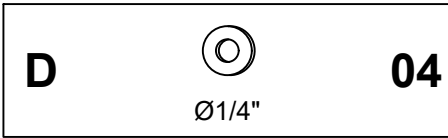
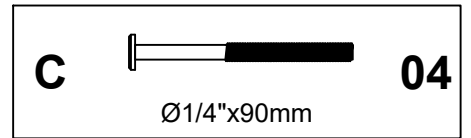
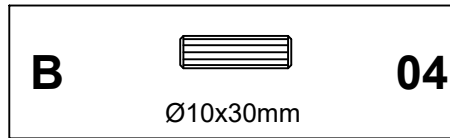
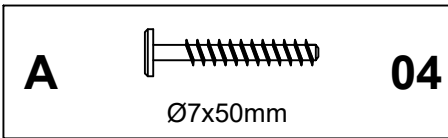

**01**

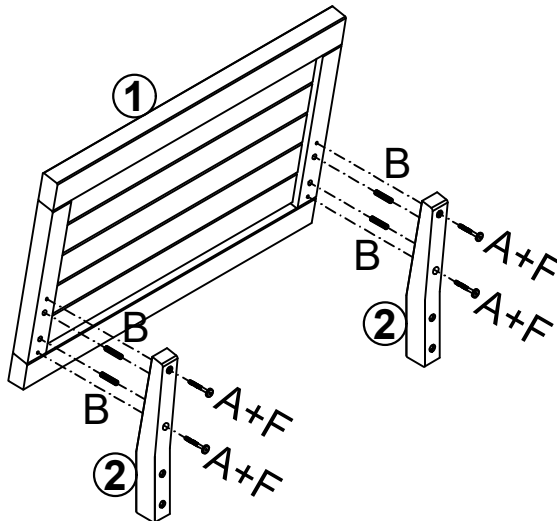
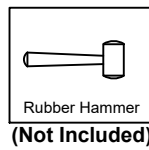
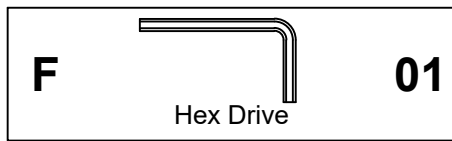
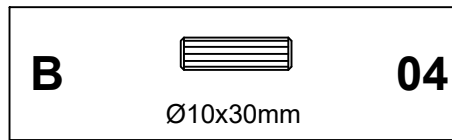
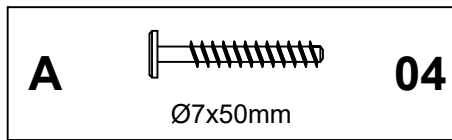

**02**

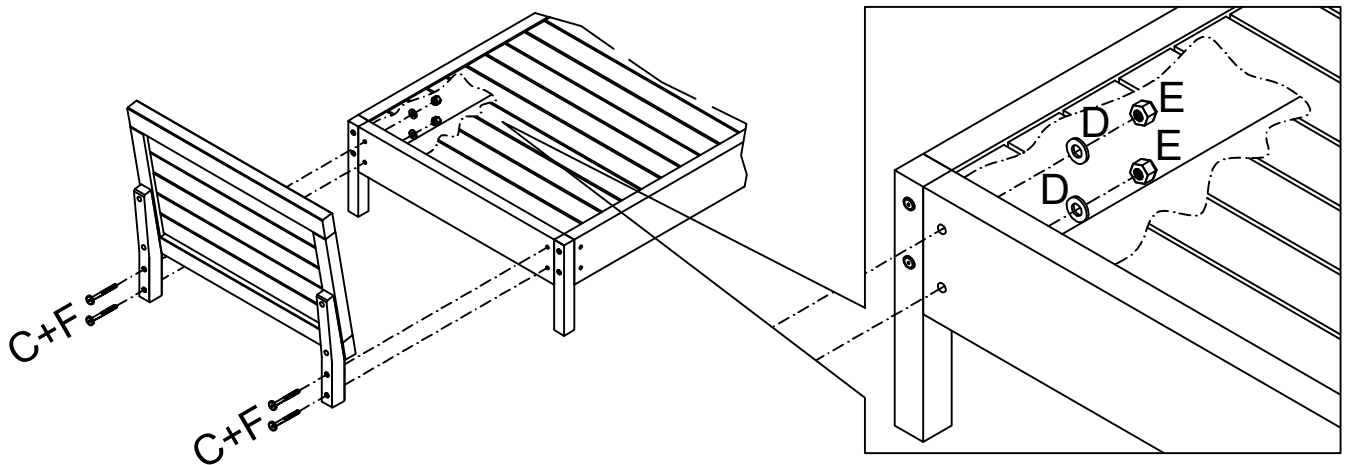
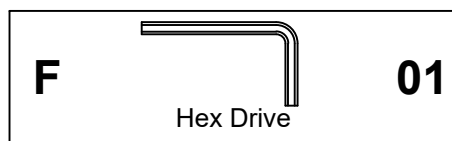
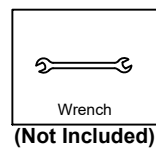
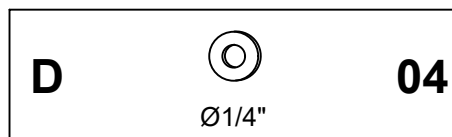
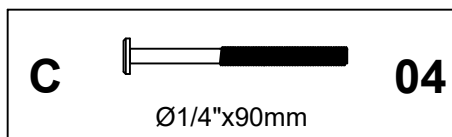

# ASSEMBLY INSTRUCTIONS

## SINGLE CHAIR

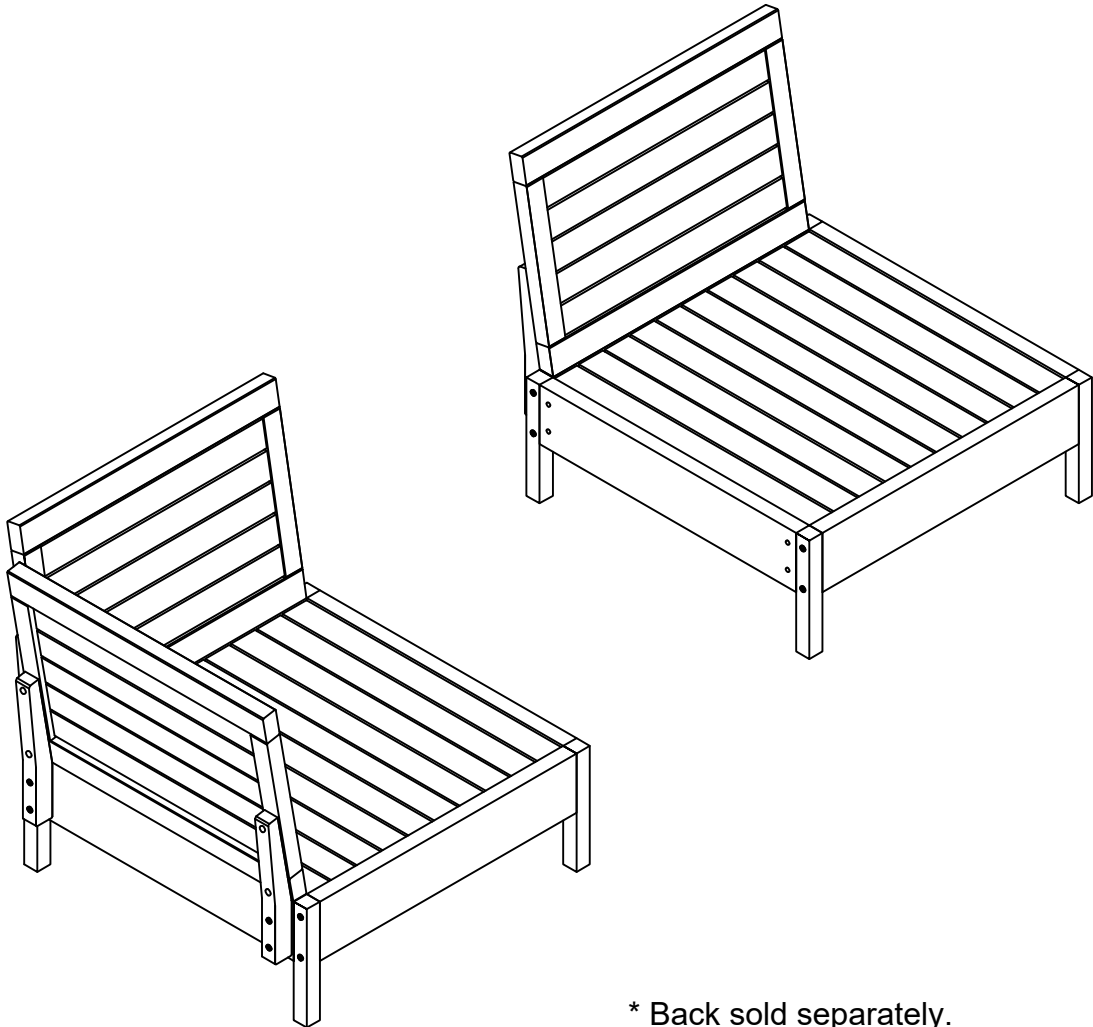

\* Back sold separately.

### Tools Required (Not Included)

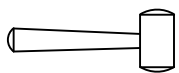

Rubber Hammer

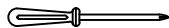

Phillips Screwdriver

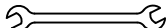

Wrench



Cordless Drive (\*)



(\*) NOTE: Optional - use in place of hex drive.

**Identifying the Hardware**-Identify the hardware using the illustrations below.

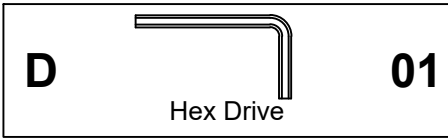
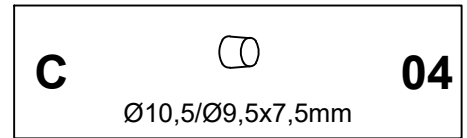
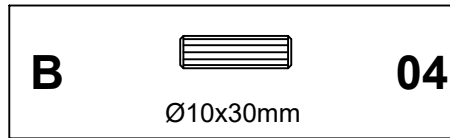
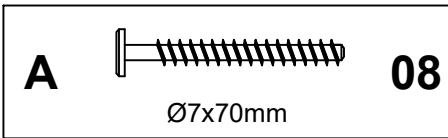

**01**

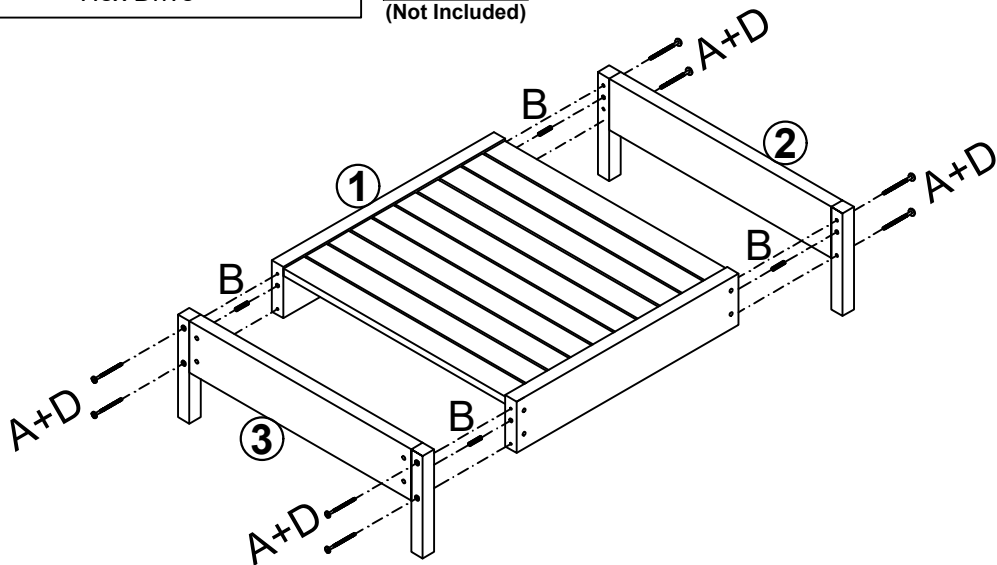
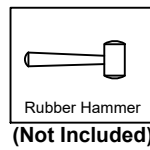
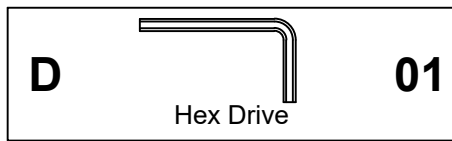
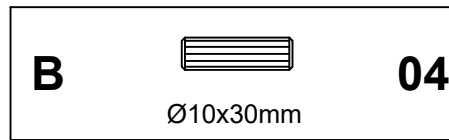
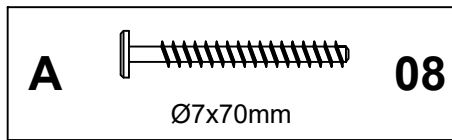

**02**

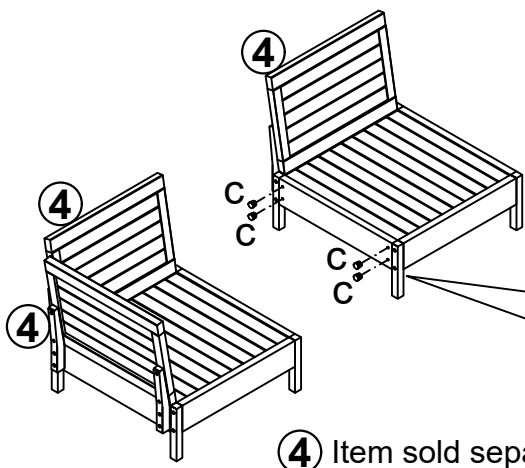
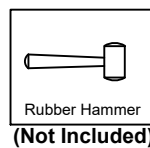
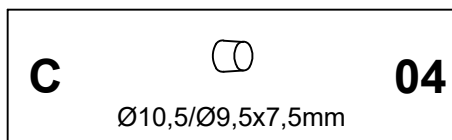

**4** Item sold separately.

