

CUSTOMER DATA SHEET - SHOWER TRAYS

SALES CODE: TR71097

DESCRIPTION: Quadrant Shower Tray 760 X 760 X 40

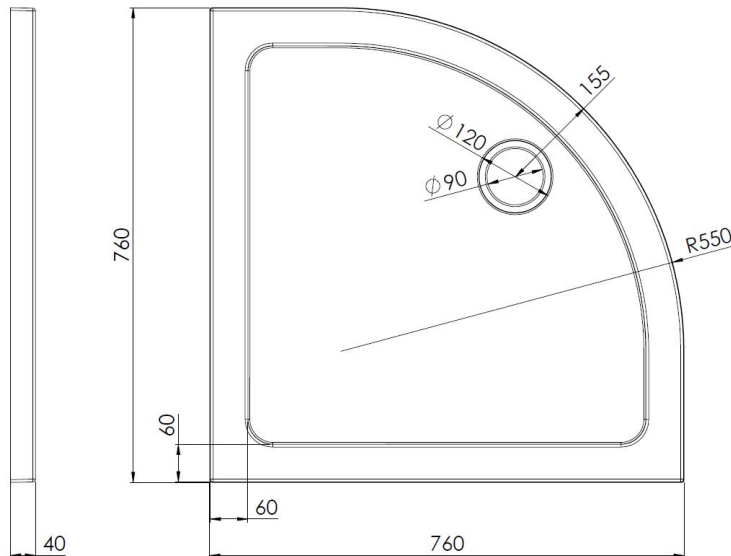

PRODUCT DIMENSIONS

Length (mm)	Width (mm)	Height (mm)	Nett Wgt Kg
760	760	40	14.07

PACKAGING DIMENSIONS

Length (mm)	Width (mm)	Height (mm)	Gross Wgt Kg
840	840	85	14.09

PACKAGING DATA

Box Colour	Shrinkwrap & Polystyrene		
Box Qty	1	Label Colour	White Label
Label Size	100 x 50	Label Qty	2

OUTER BOX DIMENSIONS (If Applicable)

Length (mm)	Width (mm)	Height (mm)	Gross Wgt Kg
Barcode	5056211813675		

PRODUCT DETAILS

Country of Origin	United Kingdom
Fitting Instruction	No
Product Material	Acrylic Capped ABS Caco3 & Pu
Mat' Colour Ref'	Slate Grey
Waste Required (mm)	90

CE Certification	Yes
Colour/Finish	Slate Grey
Radius	550
Compatible with Leg Kit	Yes