



Belldinni

Easy to install door jamb kit

QR code to have EZ installation
instructions on your phone



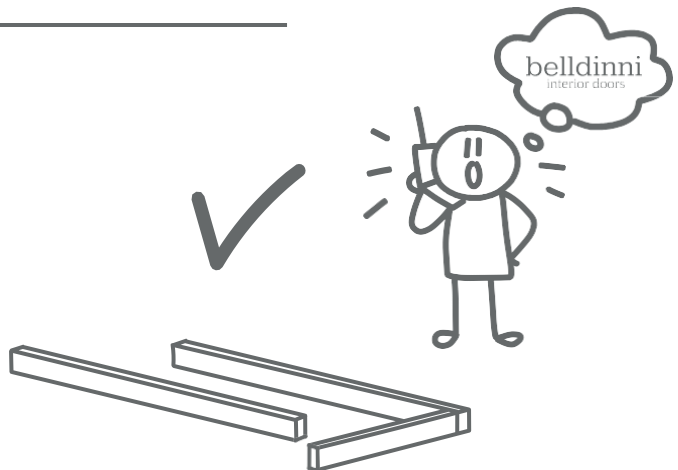
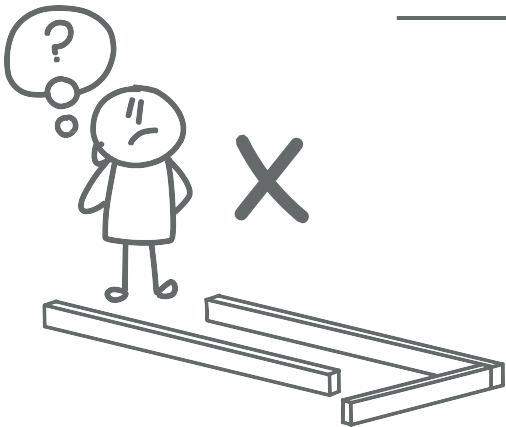
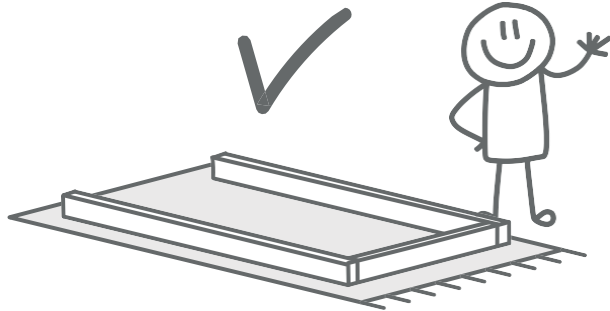
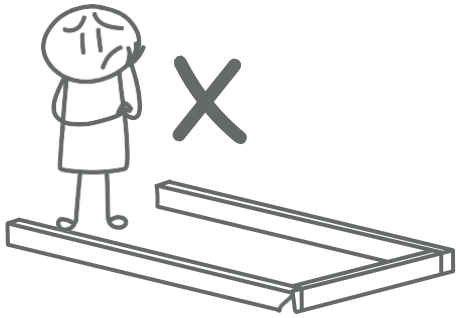
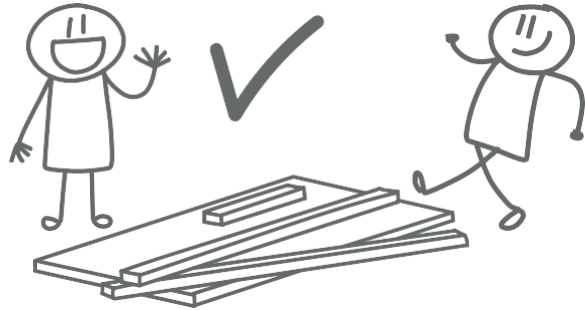
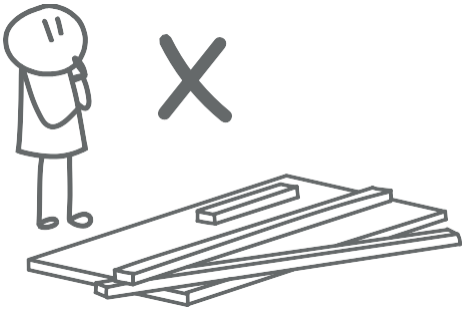

NECESSARY TOOLS

Not included

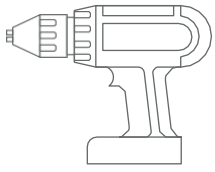

Screwdriver



Screw 1 5/8"



Pencil

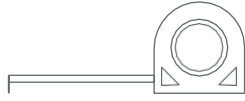

Tape measure



Garbage bags



Level



Shims
(not included)



Safety glasses

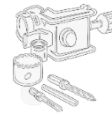

Door lock
installation kit

DOOR PARTS

(some fixtures may not be included)

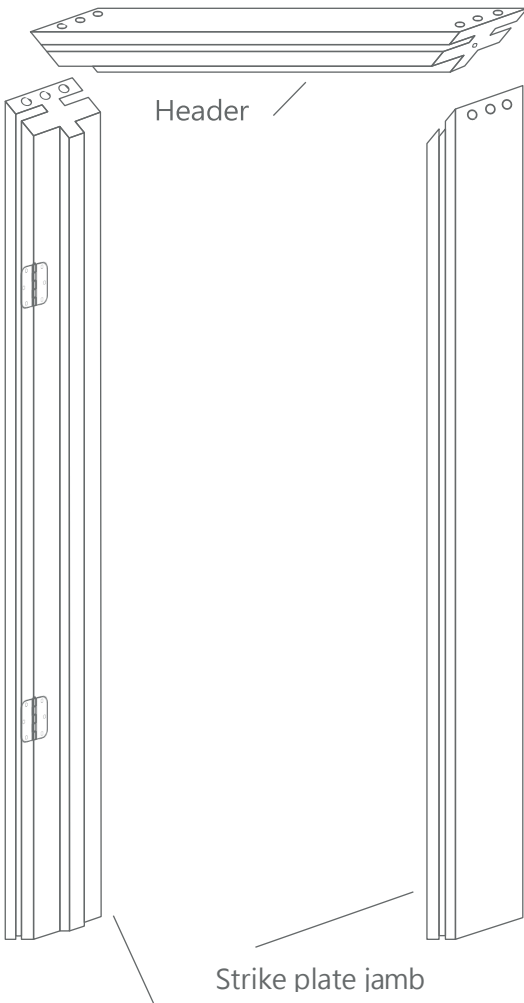

Header

Strike plate jamb

Hinges side jamb

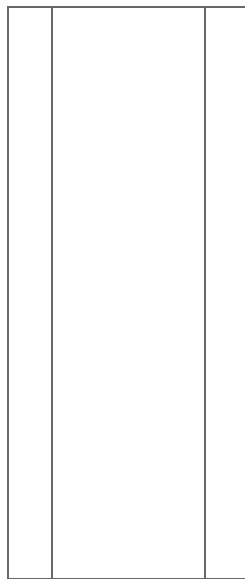

Door slab is NOT originally pre-drilled for hinges and a handle.

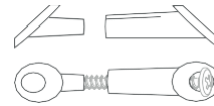

B

Screw inside white connector 4 pcs

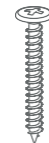

C

Black 4 pcs. opposite connector

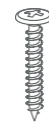

F

Screw 6 pcs.



G

Screw 18 pcs.



D

Dowel 2 pcs.

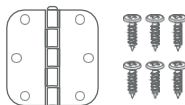

Qty depends on the height of the door (2 or 3 pcs).
Hinge type can vary.

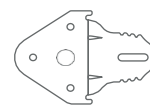

E

Quick hanger 6 pcs
(may not be included)



Do not use standard down nails and hammer



Do not step on the door



Do not lay on edges



Do not lean on

WARNING

Please do not throw away the packing cardboard until the end of

STEP 1.

Check your order

Check the contents of your door unit according to the door parts description above (page 3)

If you have any problems or questions, please contact us via diy@belldinni.com or by phone # 646 980 3191

Measure rough opening to make sure all sizes are correct:

Door slab should be at least 2" narrower than the opening width, we recommend the door slab to be 2,5" narrower than the opening width. Door slab should be at least 2" shorter than the opening height.

Check swing directions according to the chart below

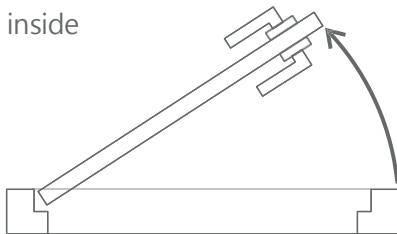

outside

Left hand inswing

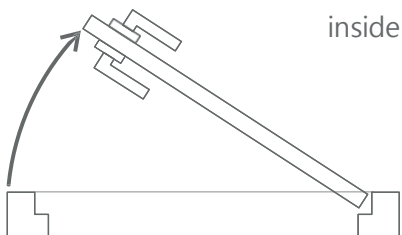

inside

outside

Right hand inswing

STEP 2.

Connect the door frame

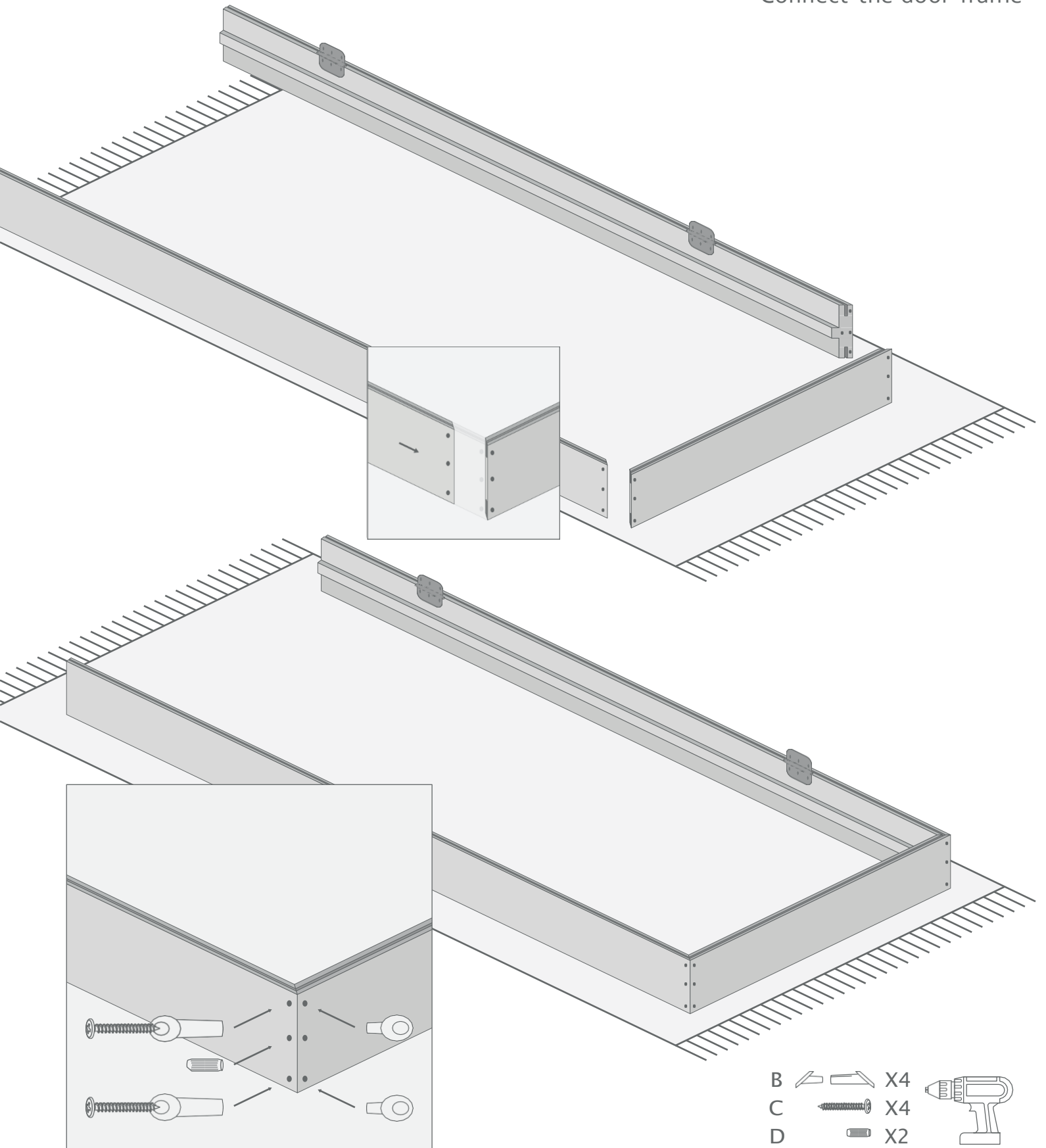

STEP 3.

Attach ez hangers

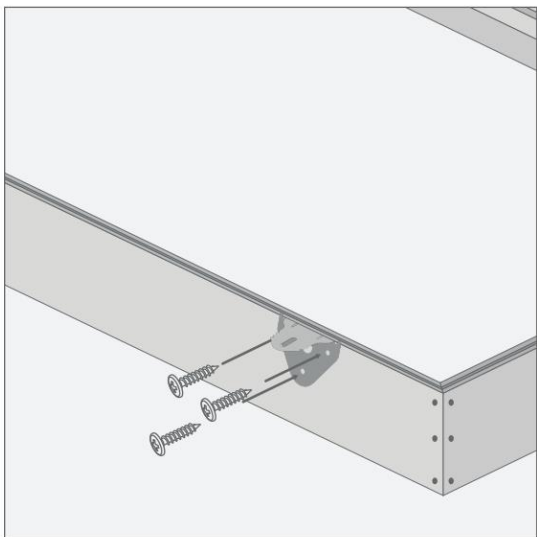
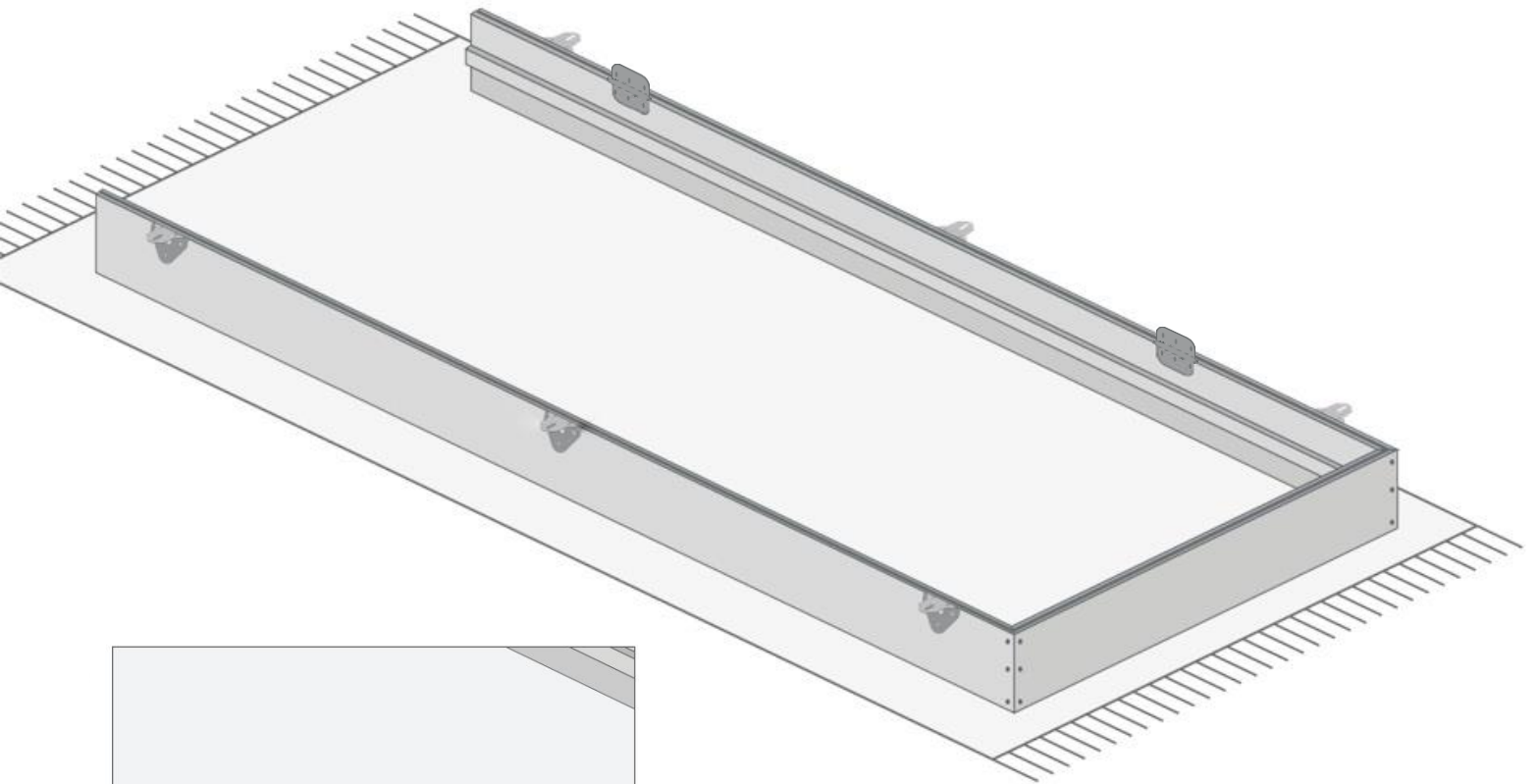

G  X18

E  X6



STEP 4.

Lay out the markings

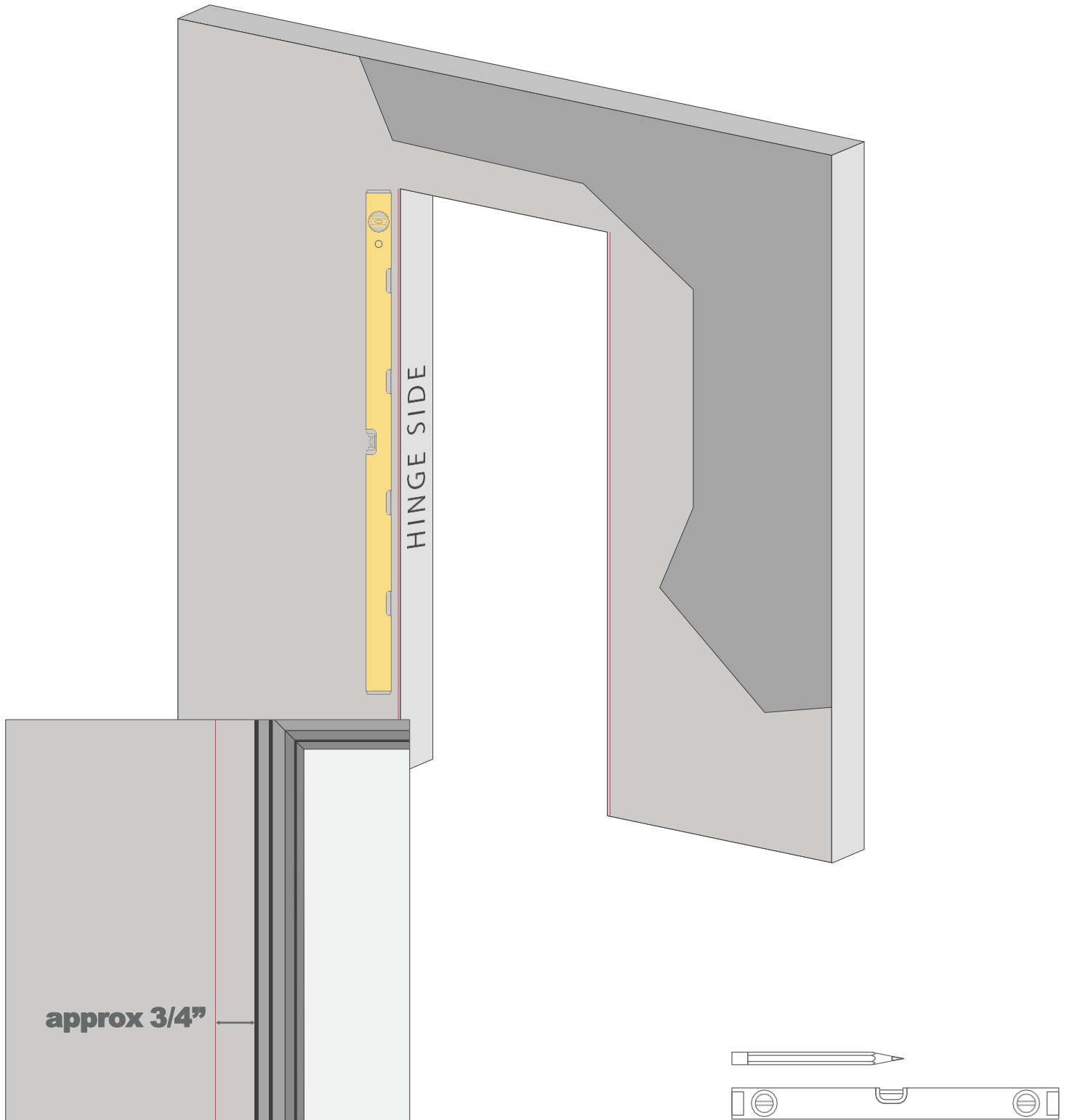

STEP 5.

Install the door frame

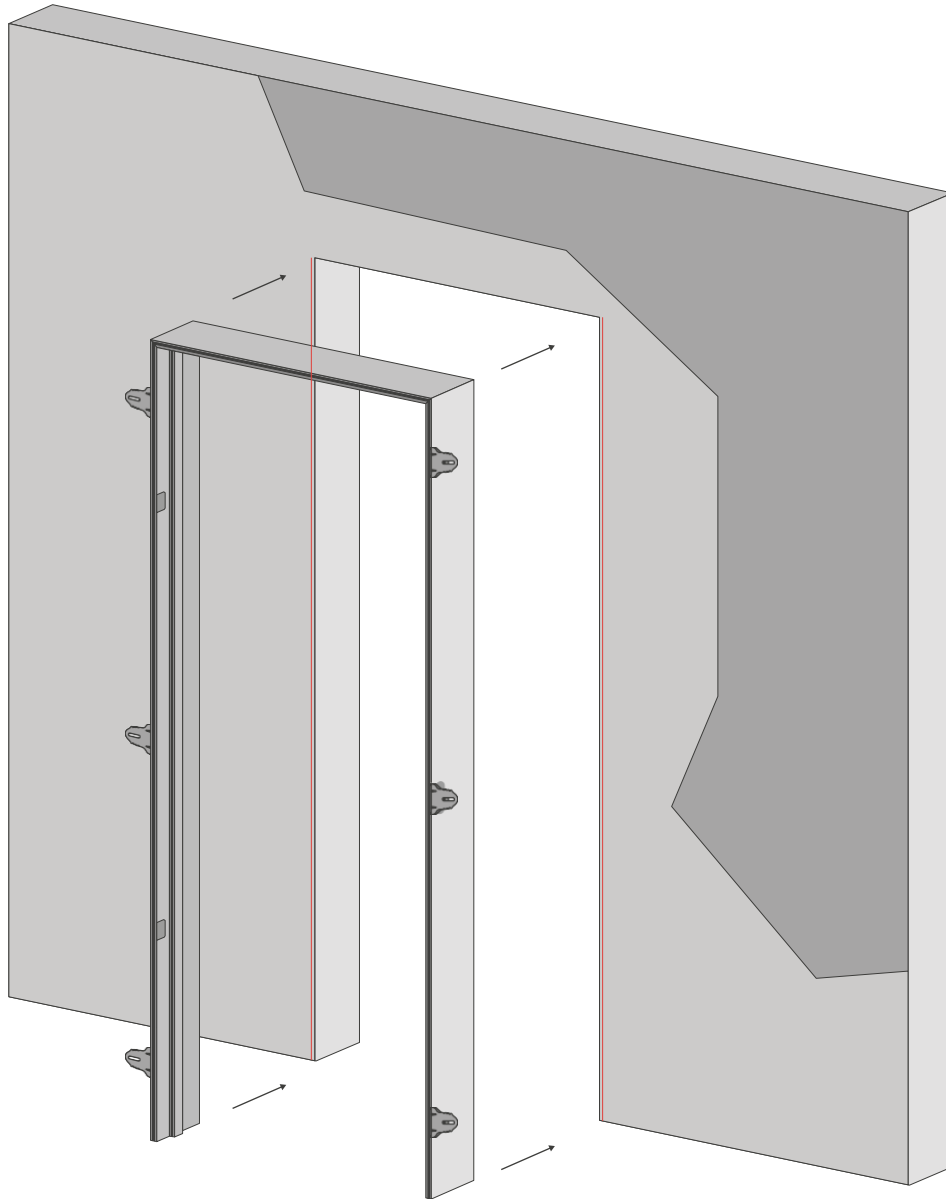

STEP 6.

Align and screw in the door frame

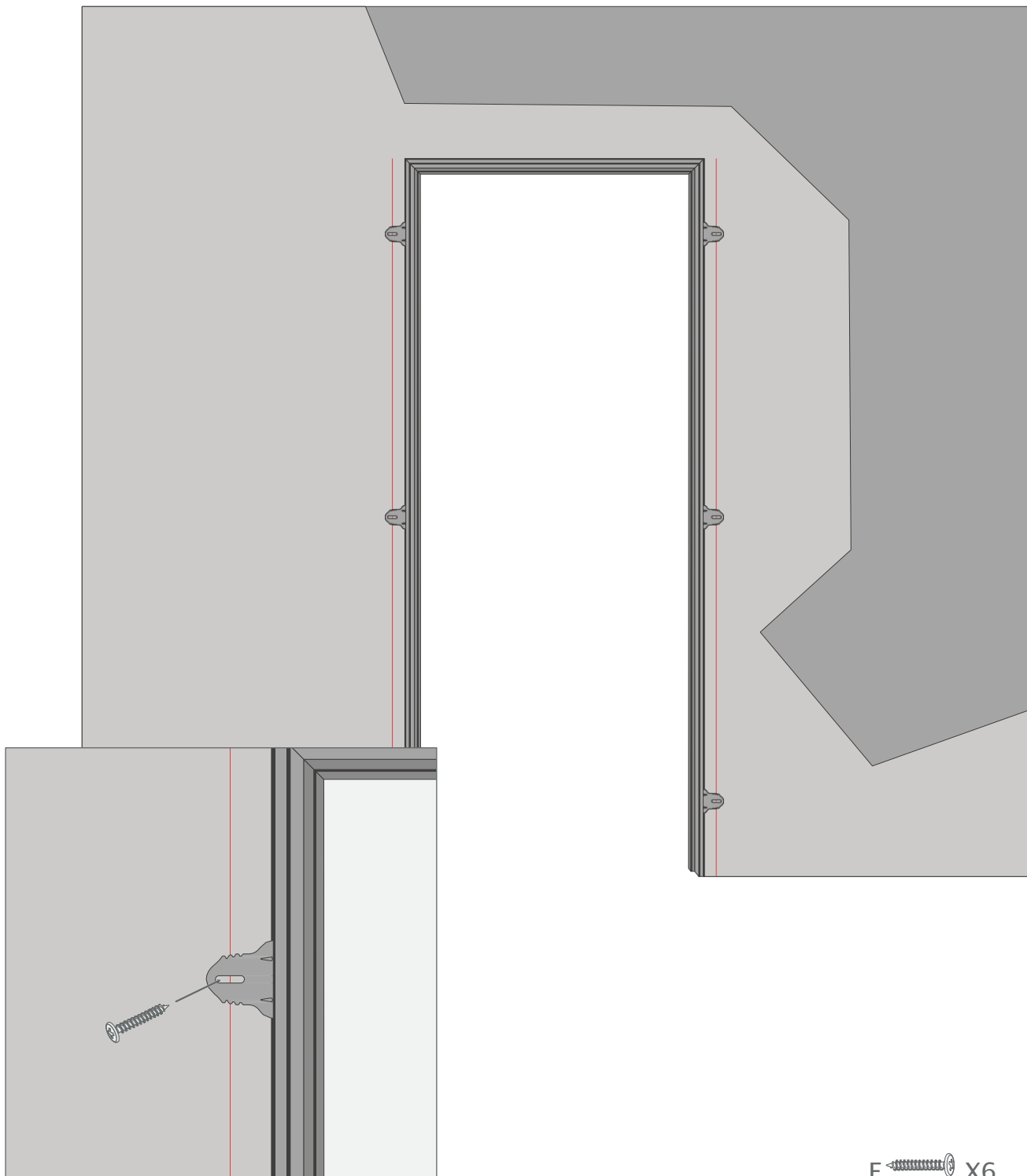

F  X6



STEP 7.

Prepare the handle bore hole

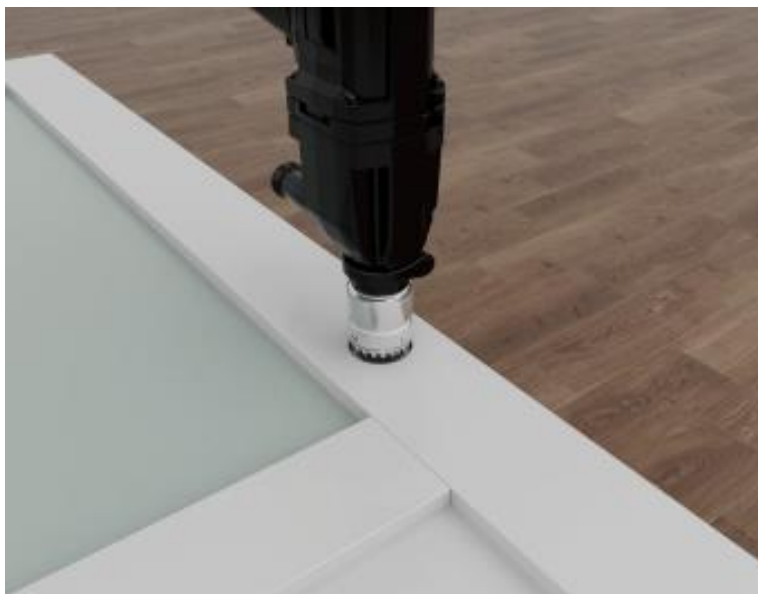

Prepare the handle bore hole on the door slab according to your hardware instruction with the help of door handle installation kit (can be found in most of the home improvement stores or online platforms).

STEP 8.

Placement of the hinges on the door

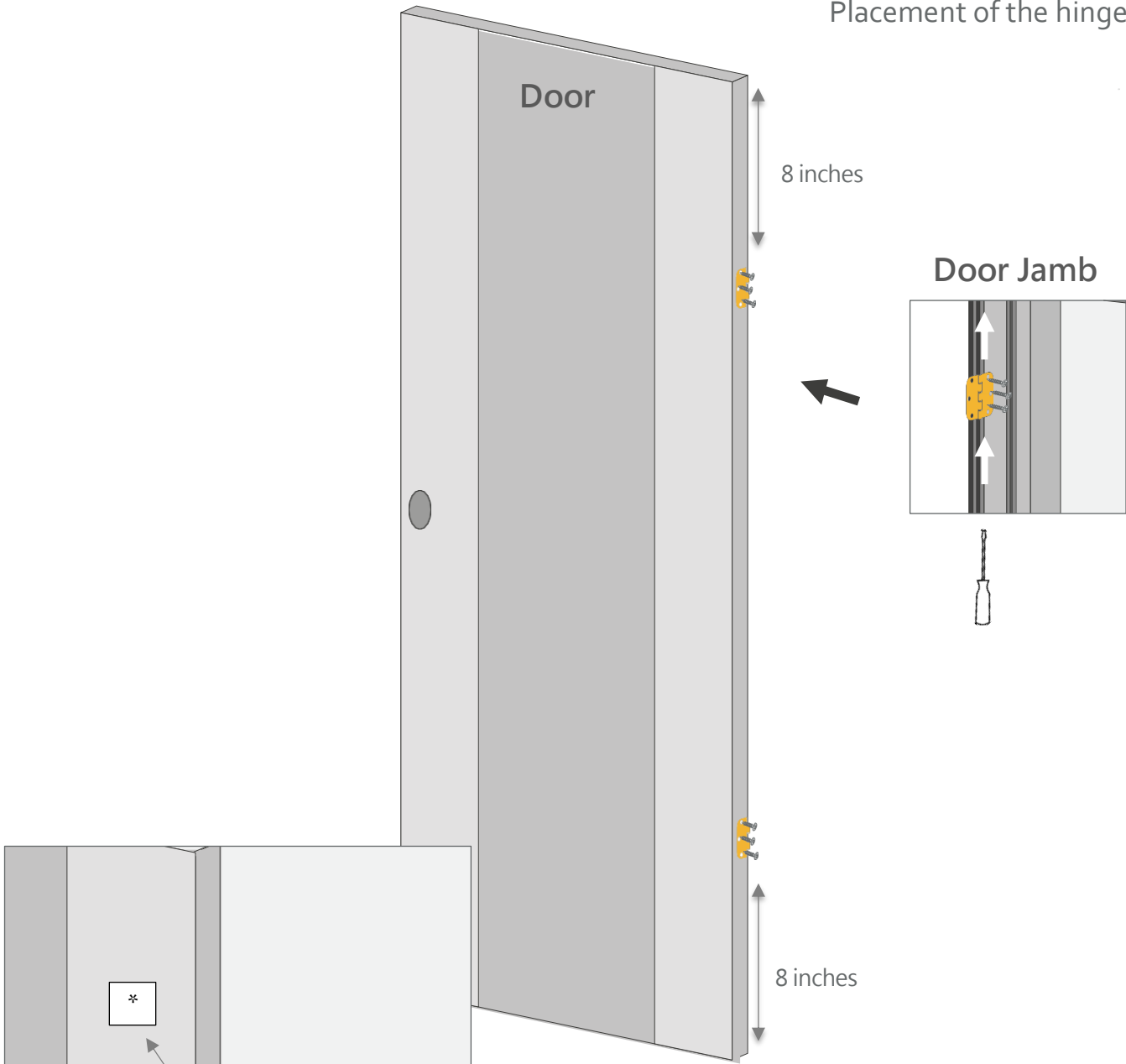

*
Distance between door edge to the hinge edge 1/4" for 1 3/4" door slab
Distance between door edge to the hinge edge 3/16" for 1 9/16" door slab

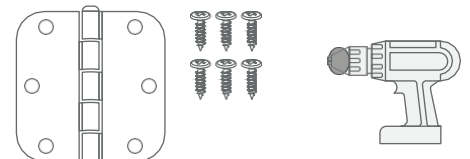

STEP 9.

Screw on the door hinges

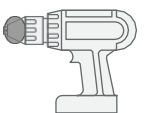
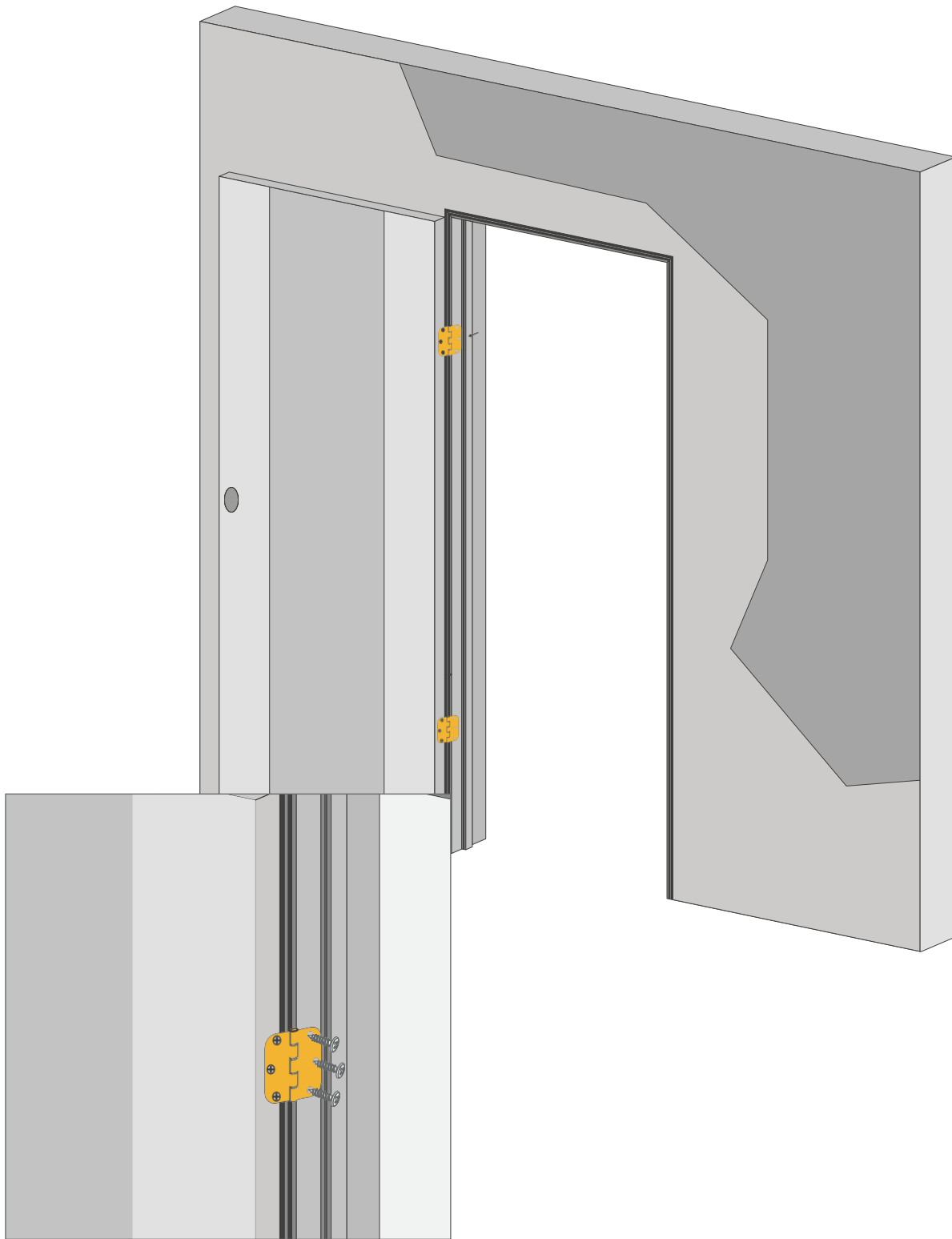

STEP 10.

Install the door slab

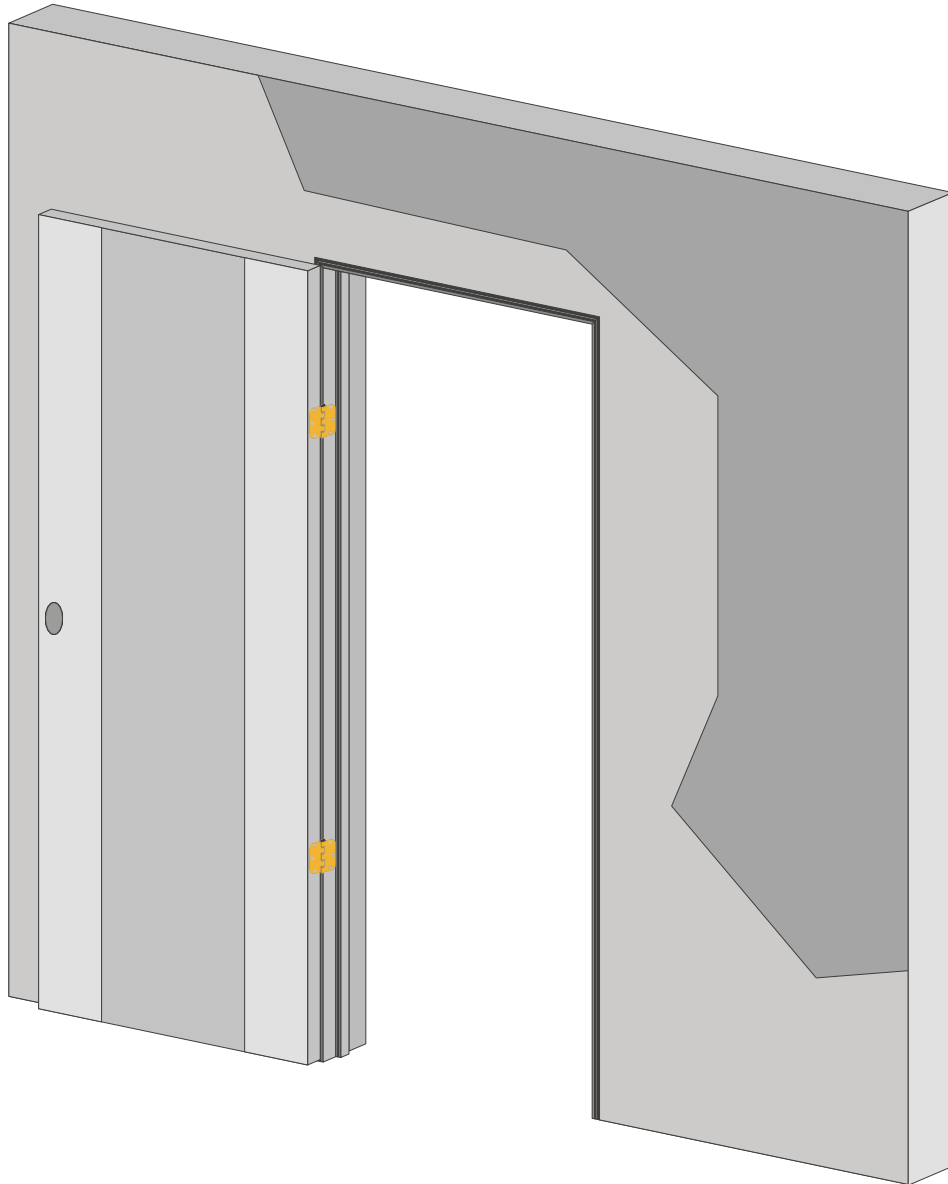

STEP 11.

Adjustment and installation

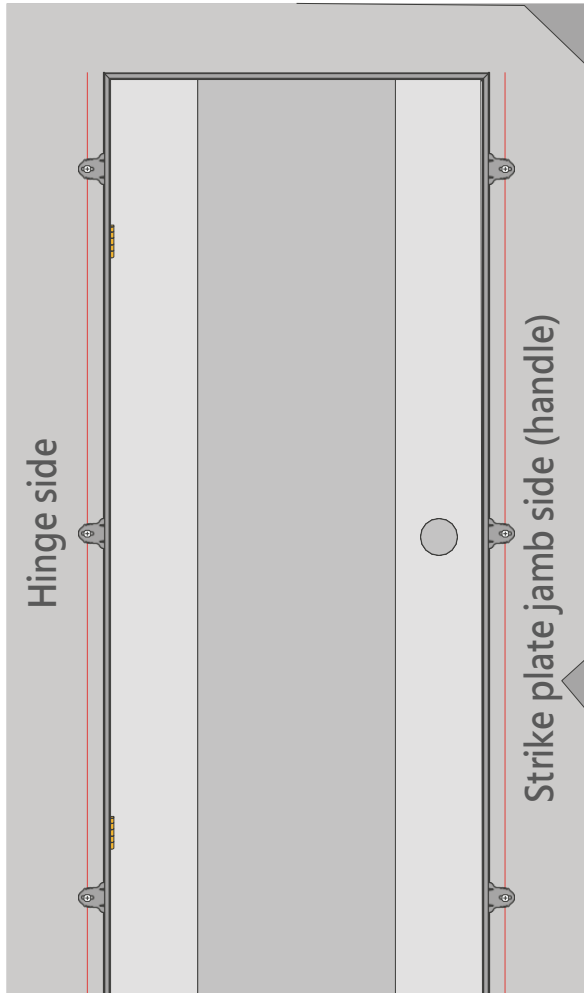

Check and adjust the hinge side of the jamb according to the level first.

Fix the hinge side jamb to the wall with the help of EZ hangers, "A" screws (1 5/8") (not included) and shims (not included) if needed.

Unscrew the screws of the strike plate side (handle side) of the jamb.

Align the door slab within door jamb (frame) minding the gaps between the door slab and the door jamb.

Hinge side of the jamb is already fixed to the wall, so the strike plate side of the jamb and the header jamb need to be adjusted.

Please note, metal EZ Hangers have the ability to be bent. In some installation cases you would need to bend them during the door installation to be as close as possible to the best installation result.

Fix the strike plate side (handle side) of the jamb and the header jamb to the wall with the help of EZ Hangers, "A" screws (1 5/8") (not included) and shims (not included) if needed.

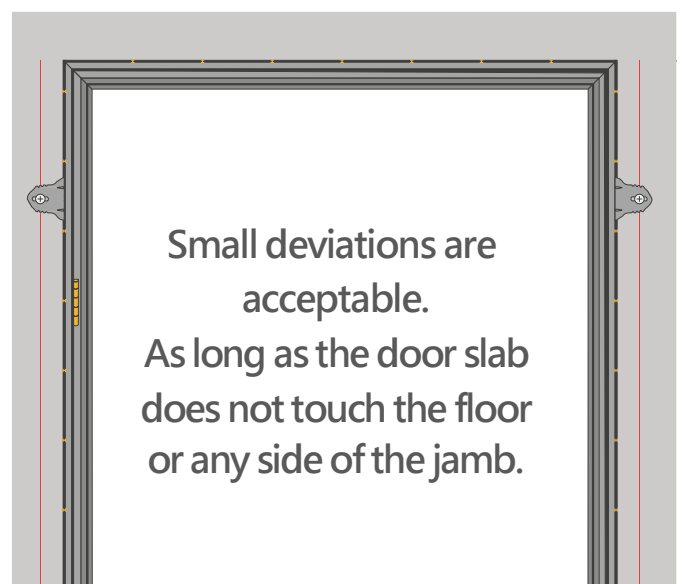

STEP 12.

Moldings installation

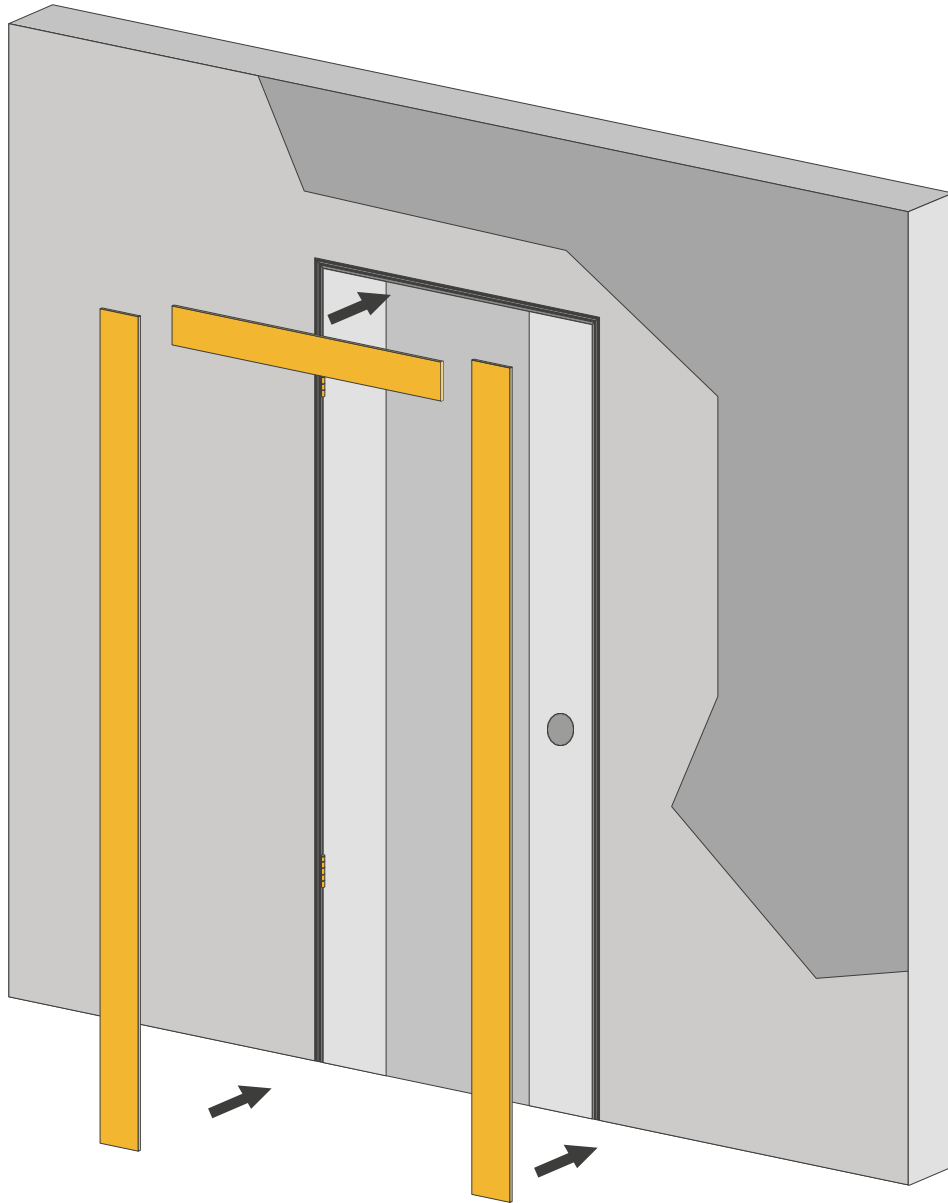

Moldings should be
purchased separately

STEP 13.

It's done

