

INSTRUCTION

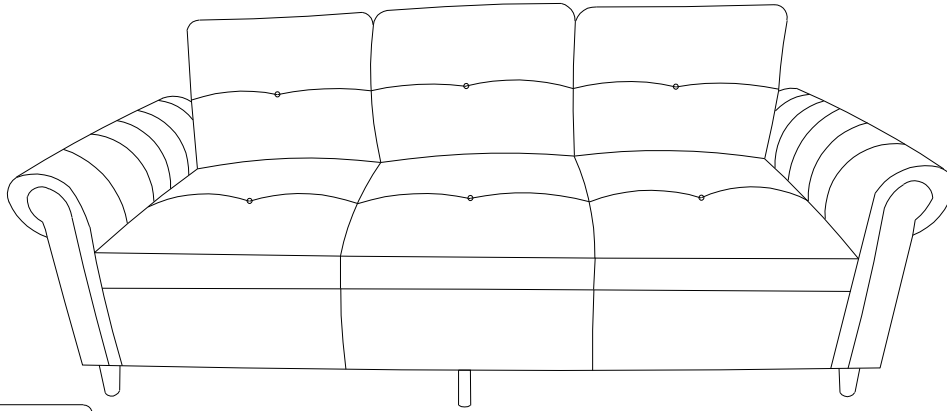

SOFA



PARTS LIST

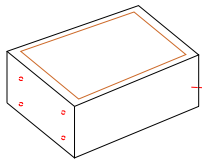

A X 1pc

Left frame

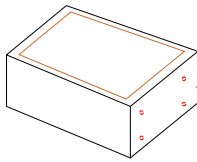

B X 1pc

Right frame

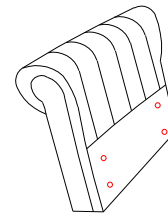

C X 1pc

Left arm

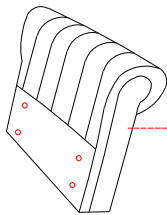

D X 1pc

Right arm



E X 3pc

Back cushions

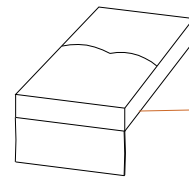

F X 3pc

Seat cushions

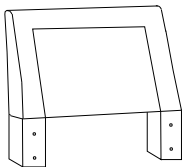

G X 2pc

Backrest

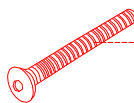

H X 16pc
(M8*40mm)

Long screws



I X 4pc
(10cm)

Legs

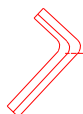

J X 1pc

L-Shaped Wrench



K X 4pc
(M8 x 25mm)

Short screw

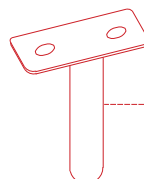

L X 2pcs
(H:105mm)

Middle Leg



M X 20pc
(M8*22mm)

Washers

STEP 1 Parts and hardware can be found in the box.

Ship by 2 box

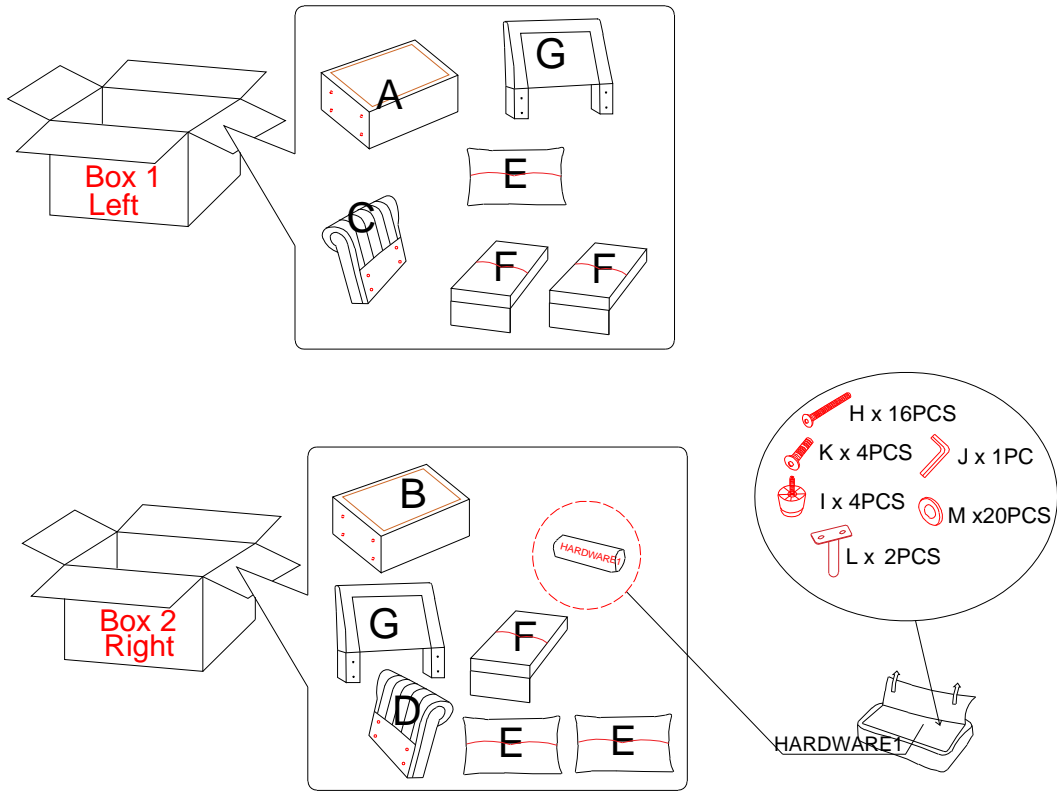

STEP 2

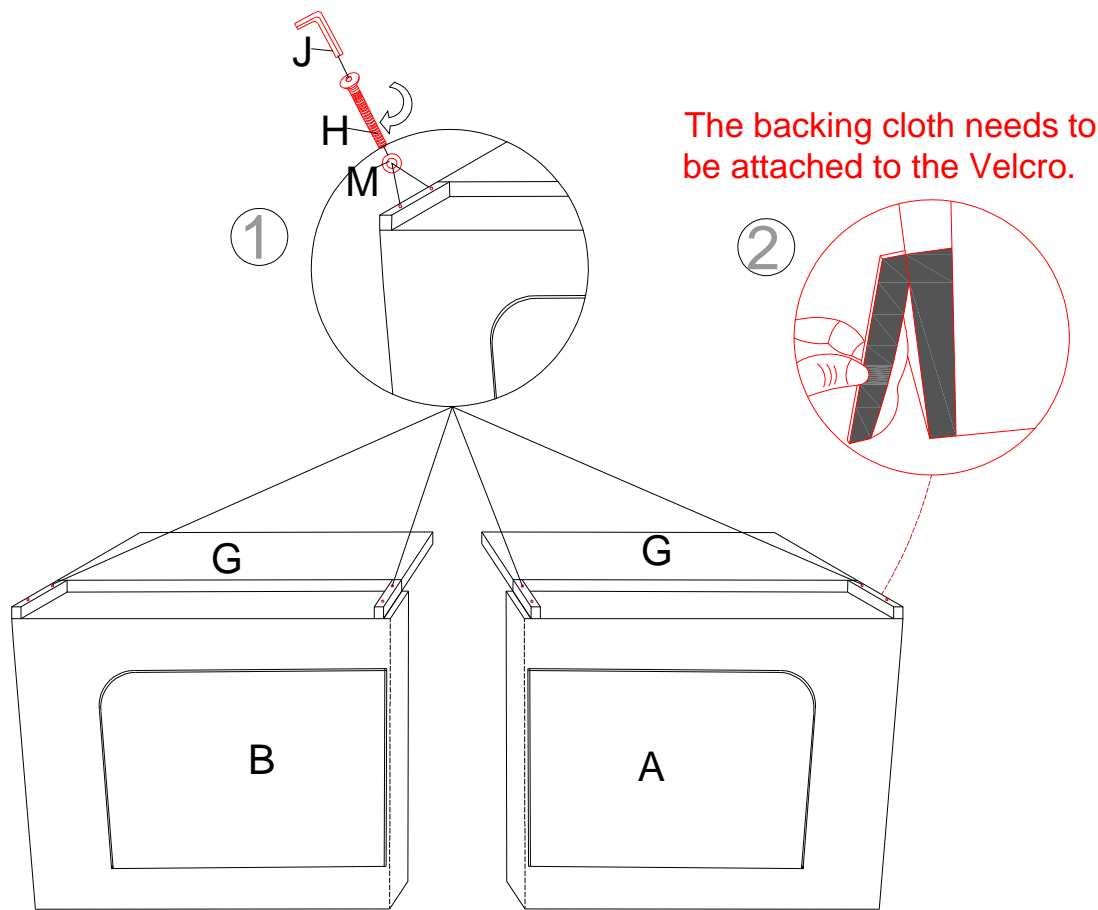

STEP 3

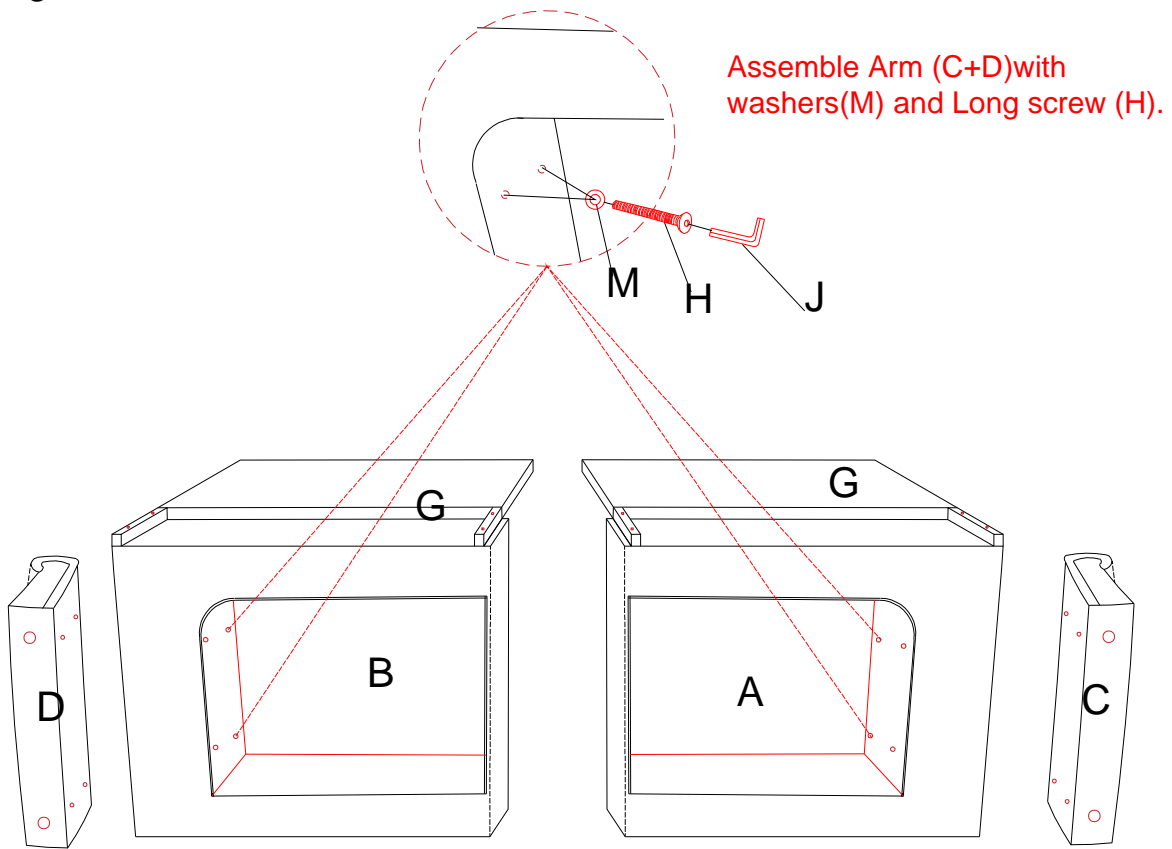

STEP 4

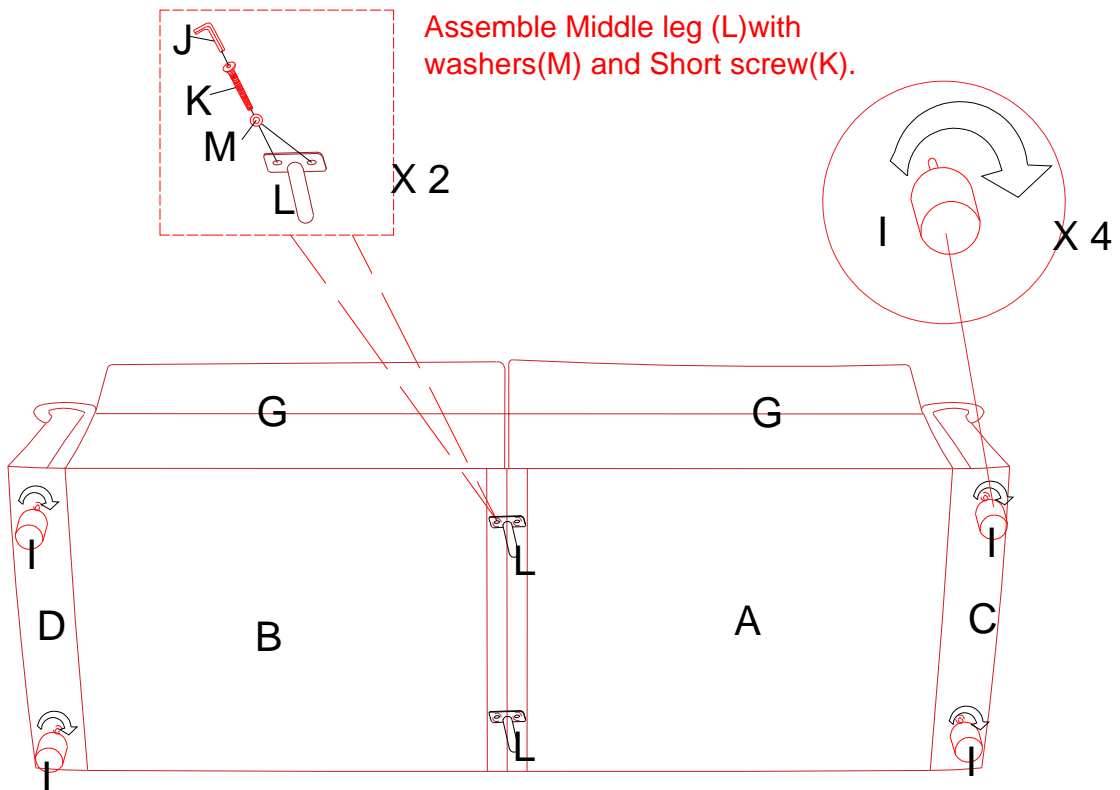

STEP 5

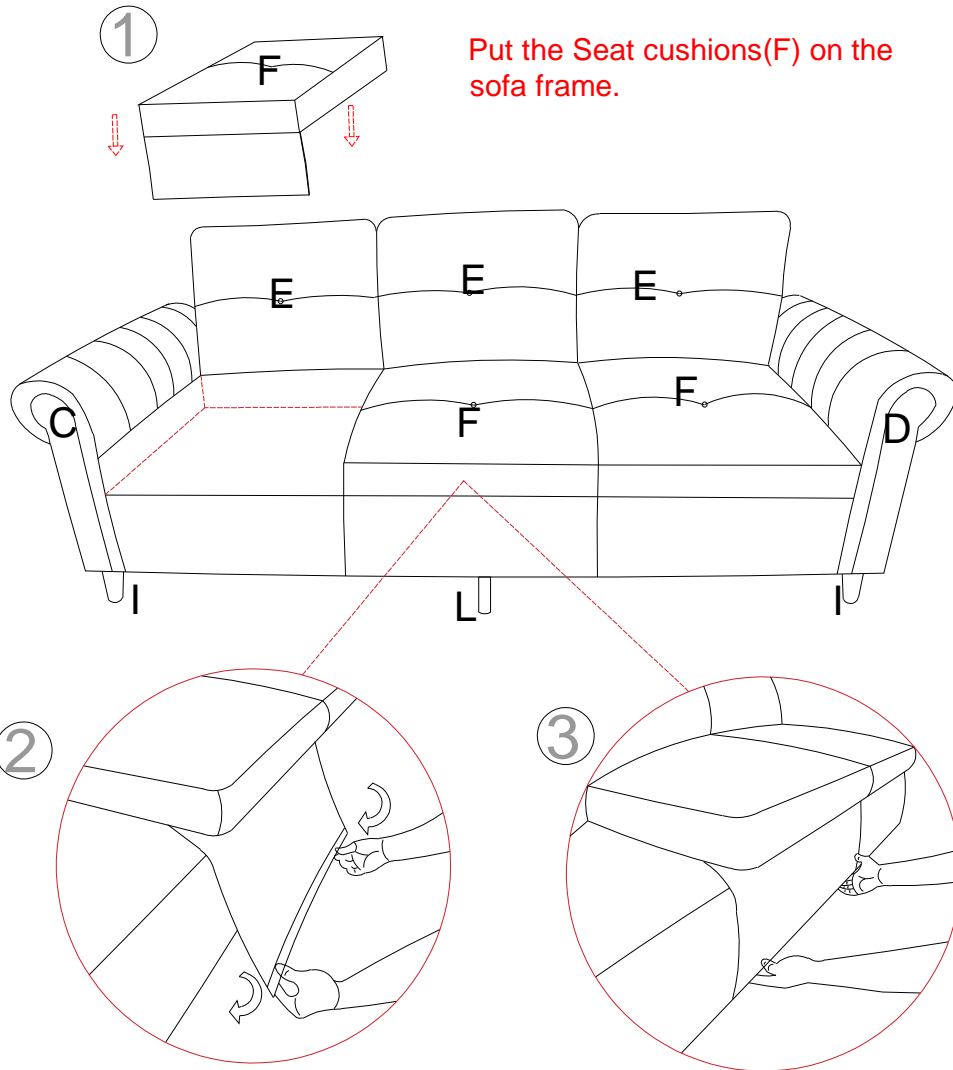

The cushion cloth needs to be attached to the Velcro.

STEP 6

