

PRODUCT ASSEMBLY INSTRUCTIONS FOR

PORTSIDE

72 " x 42 " Aluminum Dining Table Slat Top

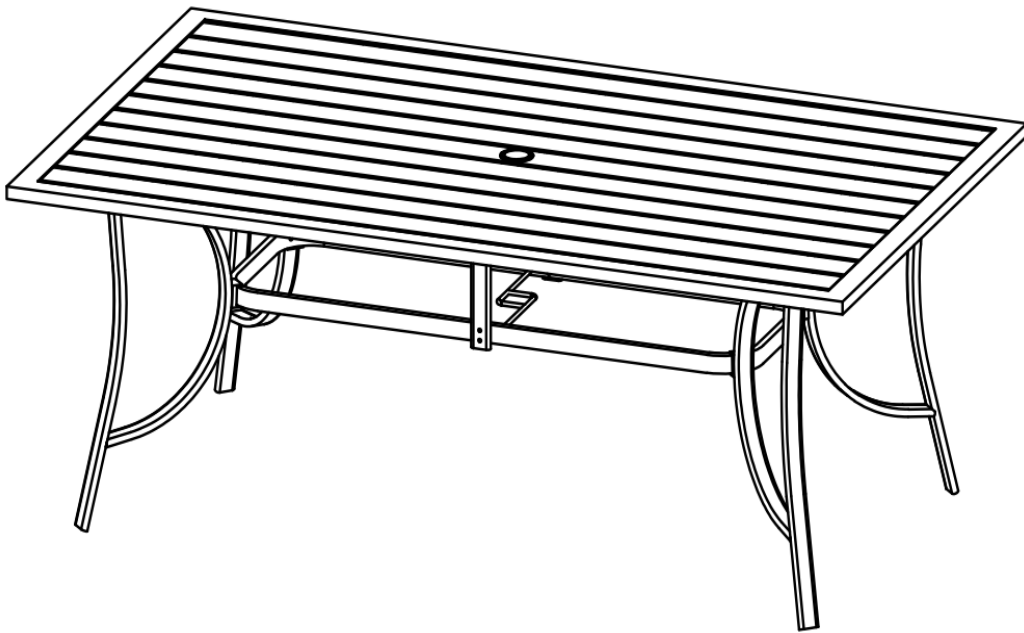

Before beginning assembly, separate all parts carefully. Please check all parts and all hardware against the diagram below before disposing of any packaging.

Do not use power tools to assemble, as they can cause reverse threading. Please assemble by hand. Power tools can be used once screws are mostly tightened, if needed.

A	B	C	D	E	F	G
1X	4X	2X	1X	10X	8X	18X
H	I	J				
18X	1X	1X				

1

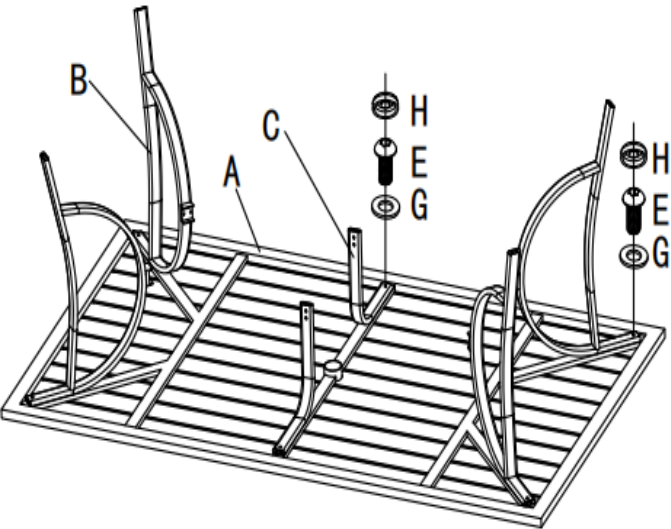

2

