

INSTRUCTION MANUAL ENCLOSED

ATTENTION

IF YOU HAVE ANY PROBLEMS OR QUESTIONS, PLEASE EMAIL OR CALL THE CUSTOMER SERVICE BEFORE YOU RETURN THIS PRODUCT TO THE STORE WHERE YOU PURCHASED FROM.

ATTENTION



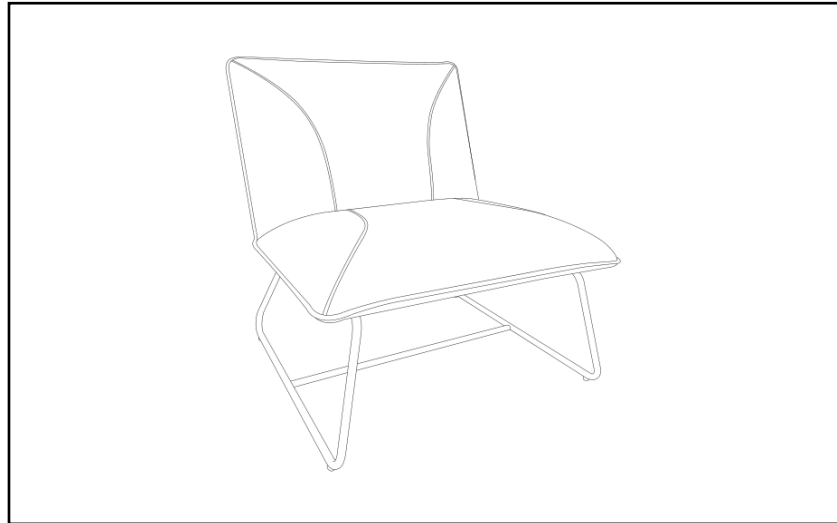

SI VOUS RENCONTREZ UN PROBLÈME OU AVEZ DES QUESTIONS, VEUILLEZ CONTACTER LE SERVICE À LA CLIENTÈLE AVANT DE RETOURNER LE PRODUIT AU MARCHAND DUQUEL VOUS L'AVEZ ACHETÉ

INDOOR CHAIR

INDOOR CHAIR ASSEMBLY INSTRUCTION

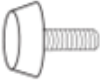

PARTS LIST			
Part		Description	Quantity
<i>PARTS</i>			
A		Seat	1
B		Base	1
<i>HARDWARE</i>			
C		Bolt M6 ×20mm	4
D		Allen Key	1
C	Spare parts	Bolt M6 ×20mm	1
E	Spare parts	Adjustable screw	1

A 	B 	C  M6*20mm	D 	E 
1pc	1pc	5pcs	1pc	1pc

PLEASE READ AND FOLLOW ALL SAFETY TIPS

GETTING STARTED

1. Before assembly, CAREFULLY use scissors or utility knife to cut and unwrap all parts. Make sure you do not discard the hardware.

***Do not tight up the bolts before finishing all steps.

1. Flip over the seat and locate the Base (B) to the Seat (A) by aligning the pre-drilled holes. Fasten all 4 pieces of Bolts (C) with Allen Key(D).

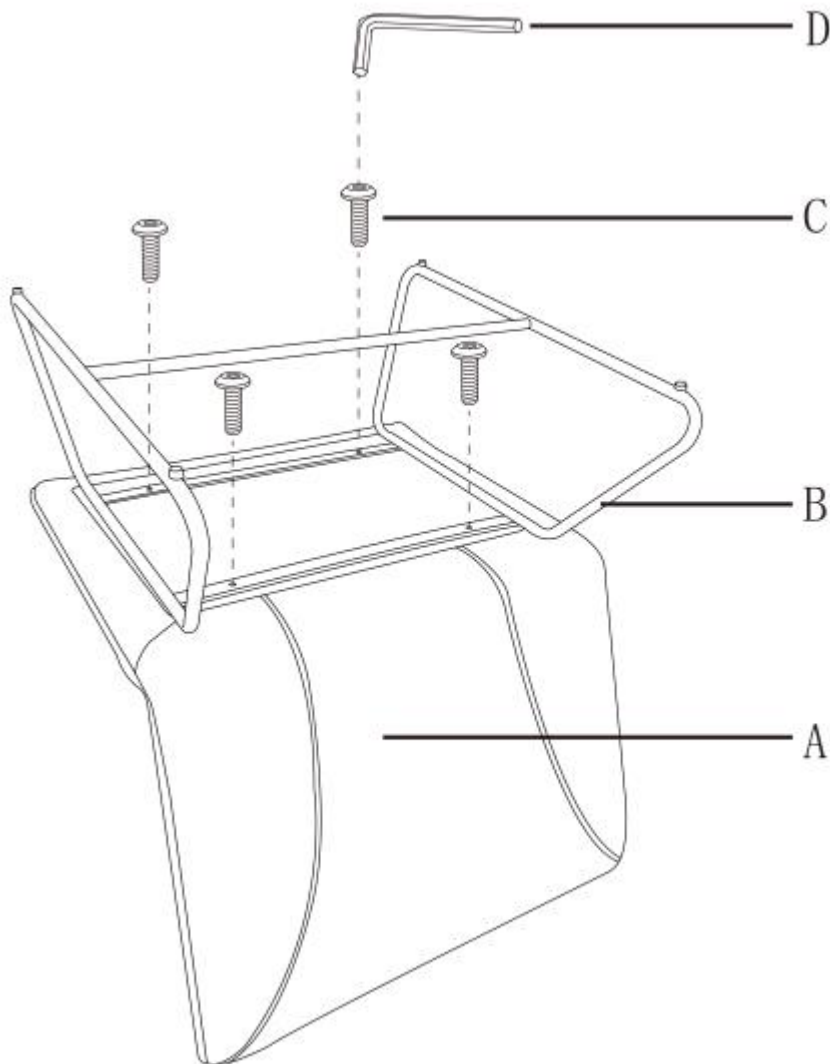

2. Turn back the whole assembled chair.

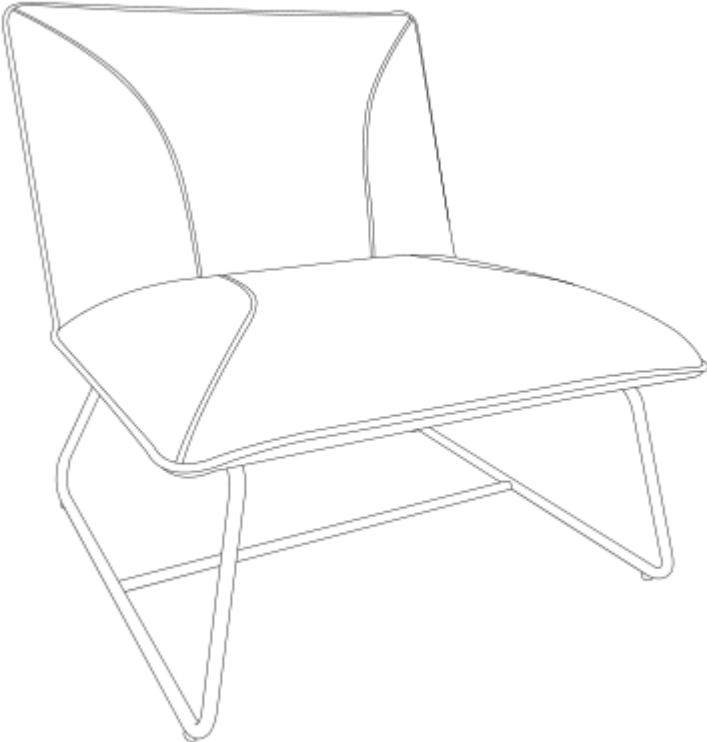

Till now you have finished the whole assembly.