









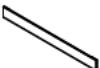

# Assembly Instructions for QUEEN BED





**Caution:** Please read instructions thoroughly before unpacking assembly parts. Sharp, exposed staple tips can cause injury, therefore, for your protection, please remove any exposed staples used in packing.

1. We recommend that you should assemble this product with the assistance of another person; this will make assembly easier, and will help to eliminate damage to the product or injury to persons during assembly.
2. Be sure to check all packing materials carefully for small parts that may have come loose inside the carton during shipment.
3. Please do not over tighten screws or bolts.
4. Please put all parts on a non-abrasive floor before assembly, and follow the assembly steps to assemble your newly purchased product correctly and efficiently.

No	Parts List		Q'ty
<b>A</b>		Headboard Panel	1 Piece
<b>B</b>		L&R Posts	2 Pieces
<b>C</b>		Footboard	1 Piece
<b>D</b>		Side Rail	2 Pieces
<b>E</b>		Bed Slat	4 Pieces
<b>F</b>		Slat Support Leg	4 Pieces
<b>G</b>		Headboard Bottom Stretcher	1 Piece

Hardware List For Headboard (F 2270-10)			
1		Allen Key L57 x4 mm	1 Piece
2		JCBC Bolt (Ø5/16" x 45mm)	6 Pieces
		Spring washer (Ø5/16"x13x1.2)	6 Pieces
		Flat washer (Ø5/16"x19x2)	6 Pieces
3		JCBC Bolt (Ø1/4" x 38mm)	2 Pieces
		Spring washer (Ø1/4"x13x1.2)	2 Pieces
		Flat washer (Ø1/4"x19x2)	2 Pieces

Hardware Bag For Footboard (F 2270-11)			
4		Wood Screw 4x25	8 Pieces

Hardware List For Rails (F 2270-12)			
1		Wrench key' 1/2"x90mm	1 Piece
2		FULL THREAD BOLT (Ø5/16"x80)	8 Pieces
3		U Washer (Ø5/16")	8 Pieces
4		NUT washer (Ø5/16")	8 Pieces

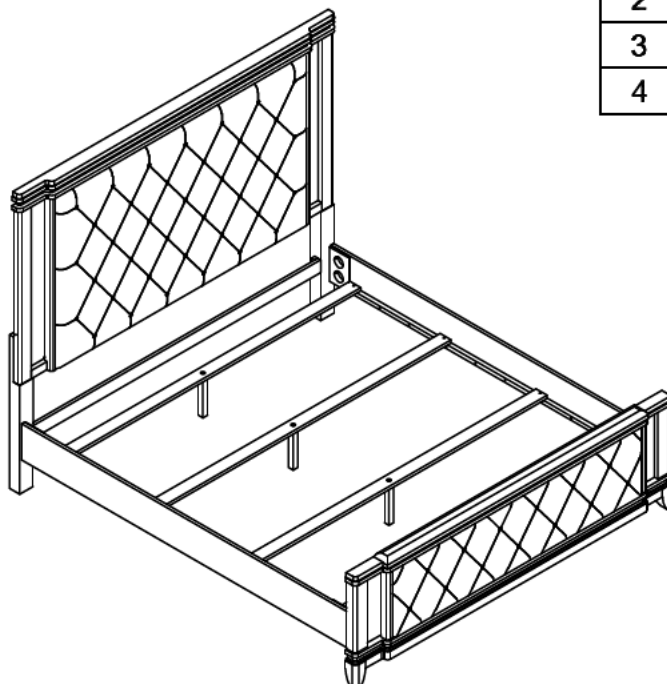



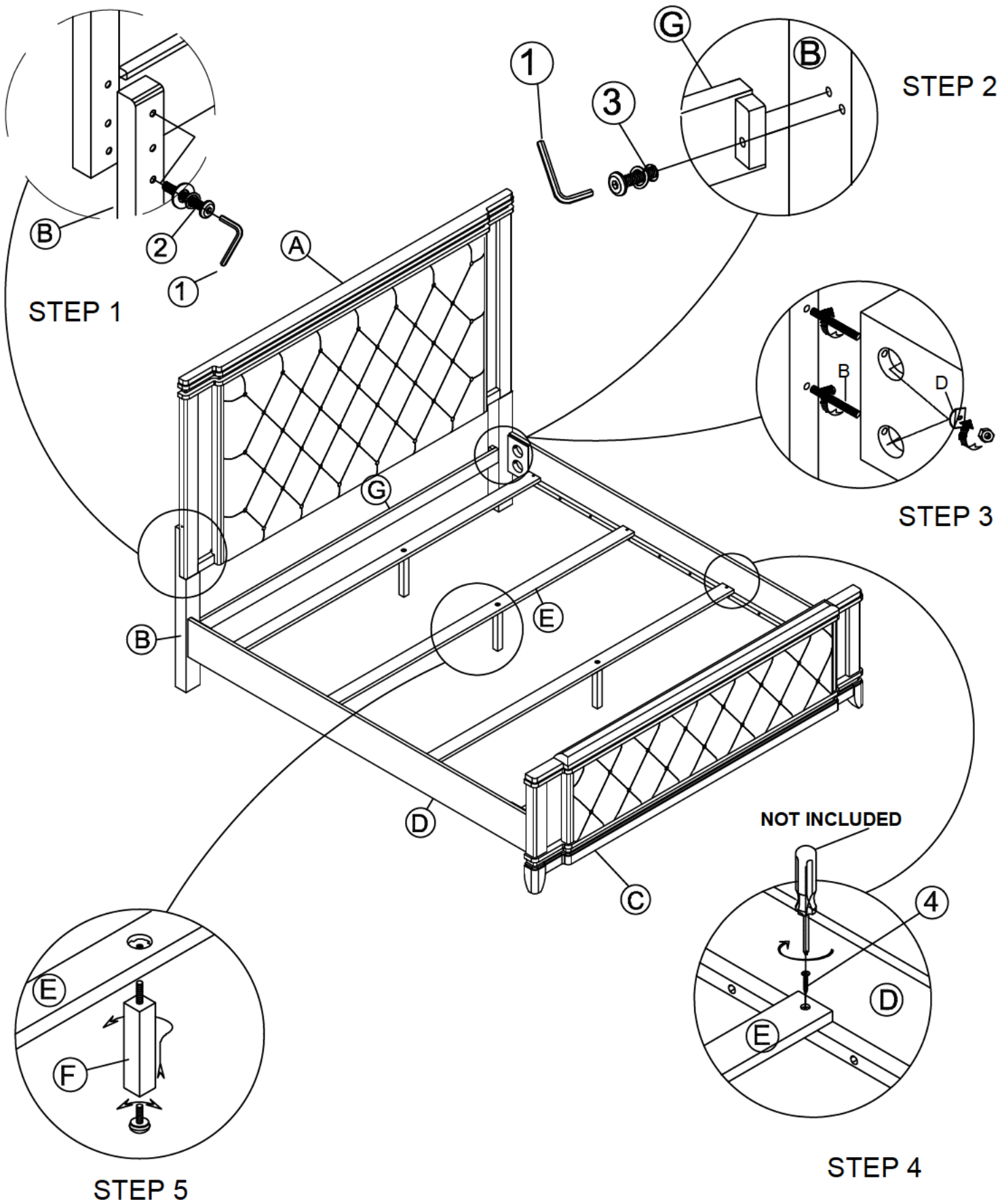



# Assembly Instructions for QUEEN BED





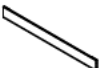

# Assembly Instructions for KING BED





**Caution:** Please read instructions thoroughly before unpacking assembly parts. Sharp, exposed staple tips can cause injury, therefore, for your protection, please remove any exposed staples used in packing.

1. We recommend that you should assemble this product with the assistance of another person; this will make assembly easier, and will help to eliminate damage to the product or injury to persons during assembly.
2. Be sure to check all packing materials carefully for small parts that may have come loose inside the carton during shipment.
3. Please do not over tighten screws or bolts.
4. Please put all parts on a non-abrasive floor before assembly, and follow the assembly steps to assemble your newly purchased product correctly and efficiently.

No	Parts List		Q'ty
<b>A</b>		Headboard Panel	1 Piece
<b>B</b>		L&R Posts	2 Pieces
<b>C</b>		Footboard	1 Piece
<b>D</b>		Side Rail	2 Pieces
<b>E</b>		Bed Slat	4 Pieces
<b>F</b>		Slat Support Leg	8 Pieces
<b>G</b>		Headboard Bottom Stretcher	1 Piece

Hardware List For Headboard (F 2270-13)			
1		Allen Key L57 x4 mm	1 Piece
2		JCBC Bolt (Ø5/16" x 45mm)	6 Pieces
		Spring washer (Ø5/16"x13x1.2)	6 Pieces
		Flat washer (Ø5/16"x19x2)	6 Pieces
3		JCBC Bolt (Ø1/4" x 38mm)	2 Pieces
		Spring washer (Ø1/4"x13x1.2)	2 Pieces
		Flat washer (Ø1/4"x19x2)	2 Pieces

Hardware Bag For Footboard (F 2270-14)			
4		Wood Screw 4x25	8 Pieces

Hardware List For Rails (F 2270-15)			
1		Wrench key' 1/2"x90mm	1 Piece
2		FULL THREAD BOLT (Ø5/16"x80)	8 Pieces
3		U Washer (Ø5/16")	8 Pieces
4		NUT washer (Ø5/16")	8 Pieces

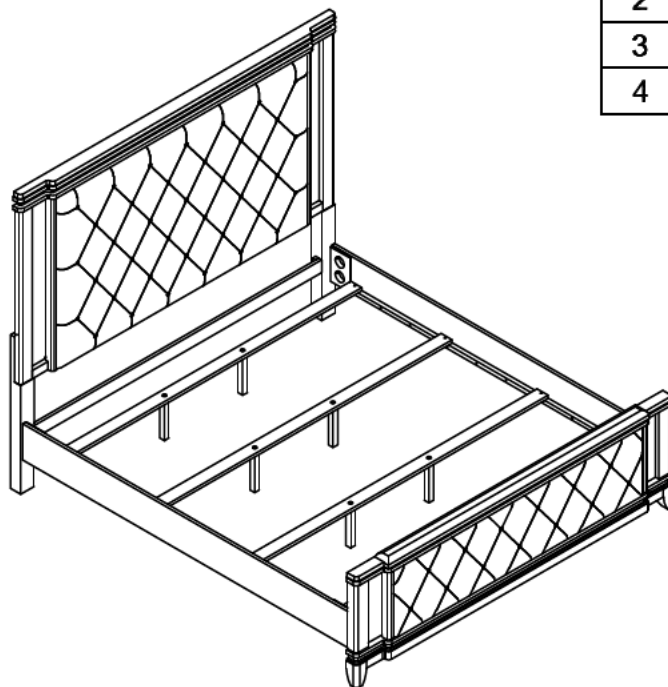

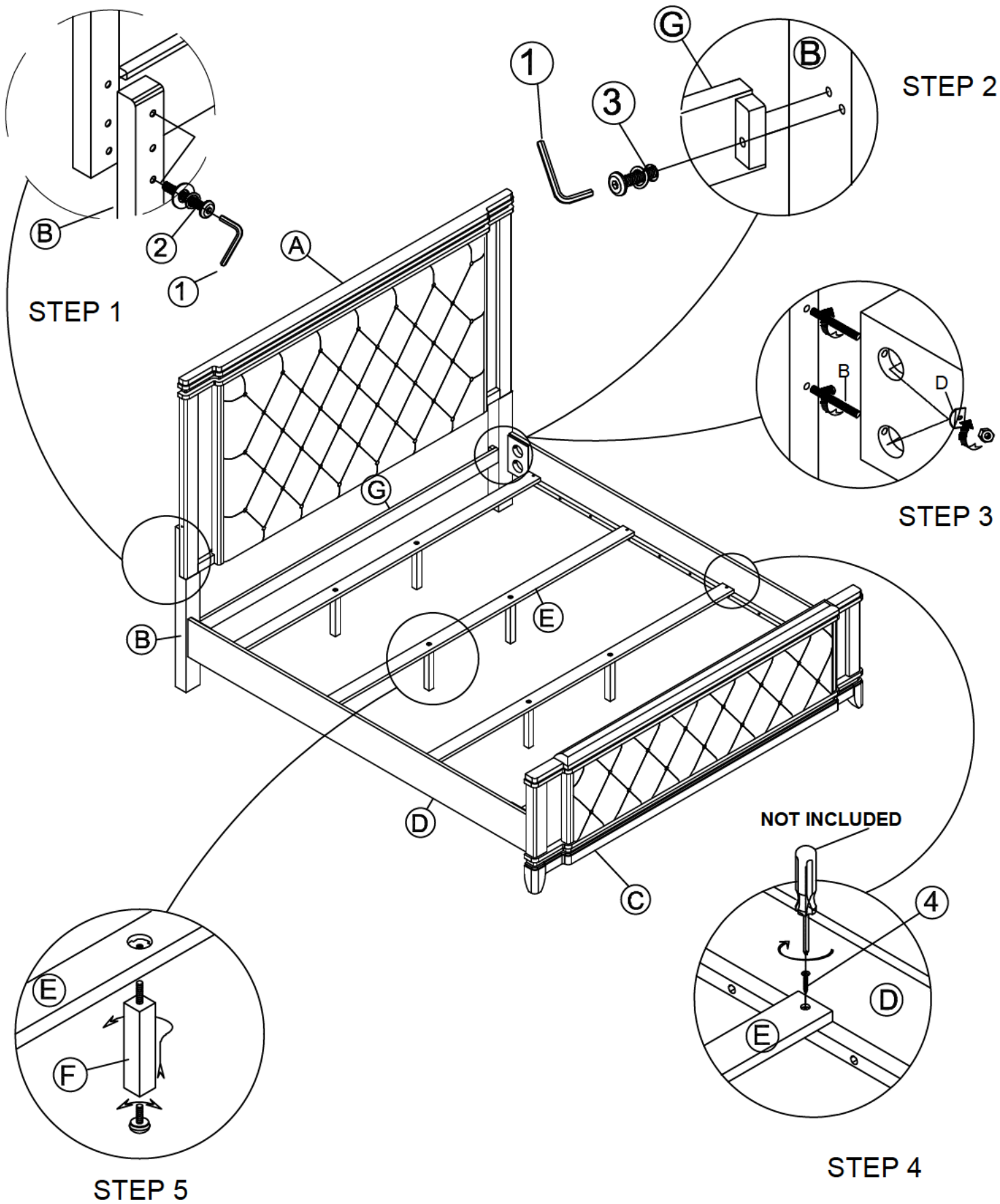

# Assembly Instructions for KING BED







# Assembly Instructions For Nightstand

**Caution:** Please read instructions thoroughly before unpacking assembly parts. Sharp exposed staple tips can cause injury, therefore, for your protection, please remove any exposed staples used in packing.

- 1 We recommend that you should assemble this product with the assistance of another person; this will make assembly easier, and will help to eliminate damage to the product or injury or person during assembly
  - 2 Be sure to check all packing materials carefully for small parts that may have come loose inside the carton during shipment.
  - 3 Please do not over-tighten bolts
  - 4 Please put all parts on a non-abrasive floor before assembly, and follow the assembly steps to assemble your newly purchased product correctly and efficiently
- . Do not allow children to climb on furniture.
  - . Do not place television sets on top of chest, door chest, and/or dressers.
  - . Please place heaviest objects on the lowest drawers.
  - . Please have no more than one drawer open at a time.

No		Parts List	Q'ty
A		Chest	1 Piece
B		Leg	4 Pieces

Hardware List			
No.	Drawing	Qty.	Description
H1		8	Bolt Ø 1/4" x 50mm
H2		8	Spring washer Ø 1/4"
H3		8	Flat washer Ø 1/4"x19mm
H4		1	Allen Key L57 x4 mm

## STEP 1

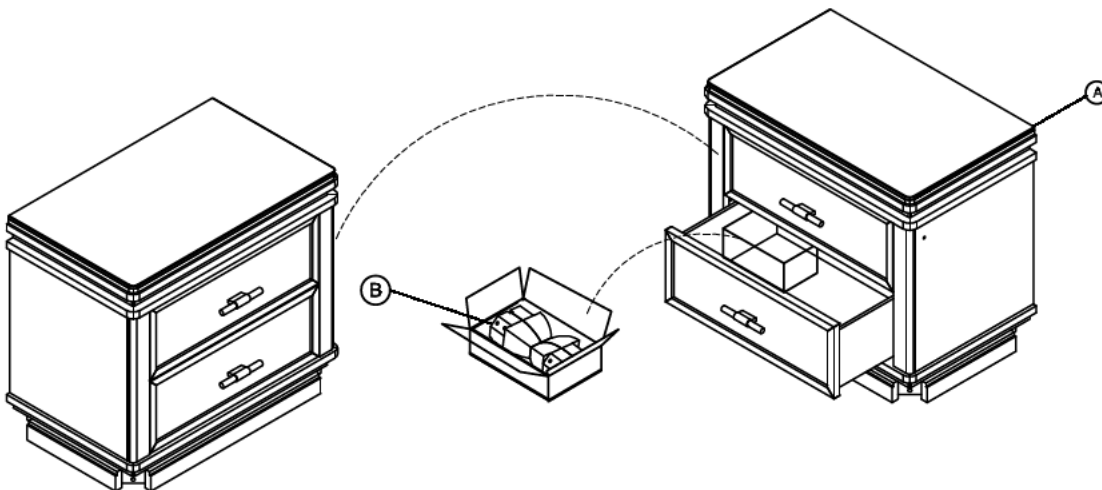

**Remark:** There is a tip restraint kit provided on the back of this product. Please read the directions thoroughly and install immediately when placed in home

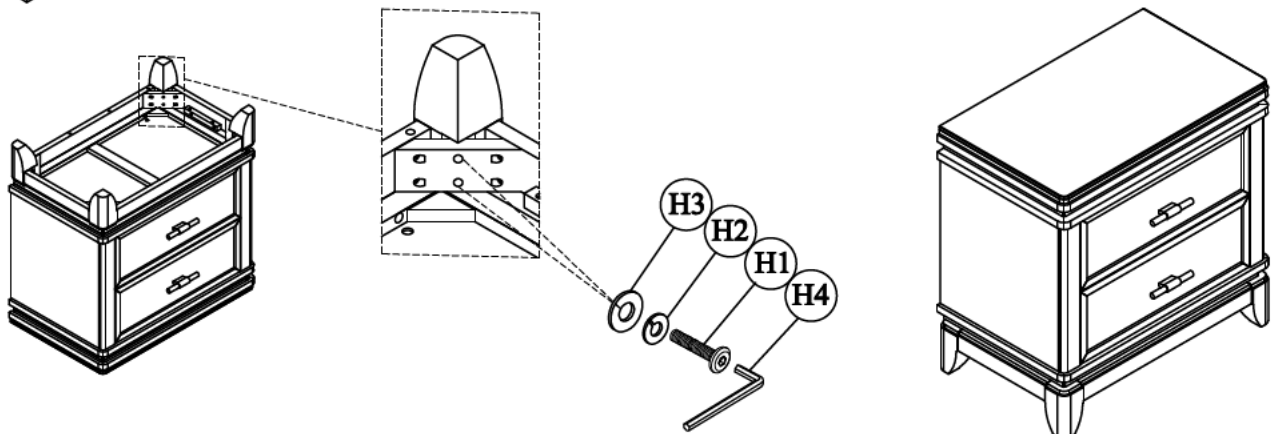

## STEP 2







# Assembly Instructions For Chest

**Caution:** Please read instructions thoroughly before unpacking assembly parts. Sharp exposed staple tips can cause injury, therefore, for your protection, please remove any exposed staples used in packing.

- 1 We recommend that you should assemble this product with the assistance of another person; this will make assembly easier, and will help to eliminate damage to the product or injury or person during assembly
  - 2 Be sure to check all packing materials carefully for small parts that may have come loose inside the carton during shipment.
  - 3 Please do not over-tighten bolts
  - 4 Please put all parts on a non-abrasive floor before assembly, and follow the assembly steps to assemble your newly purchased product correctly and efficiently
- . Do not allow children to climb on furniture.
  - . Do not place television sets on top of chest, door chest, and/or dressers.
  - . Please place heaviest objects on the lowest drawers.
  - . Please have no more than one drawer open at a time.

No		Parts List	Q'ty
A		Chest	1 Piece
B		Leg	4 Pieces

Hardwarelist			
No.	Drawing	Qty.	Description
H1		8	Bolt Ø 1/4" x 50mm
H2		8	Spring washer Ø 1/4"
H3		8	Flat washer Ø 1/4"x19mm
H4		1	Allen Key L57 x4 mm

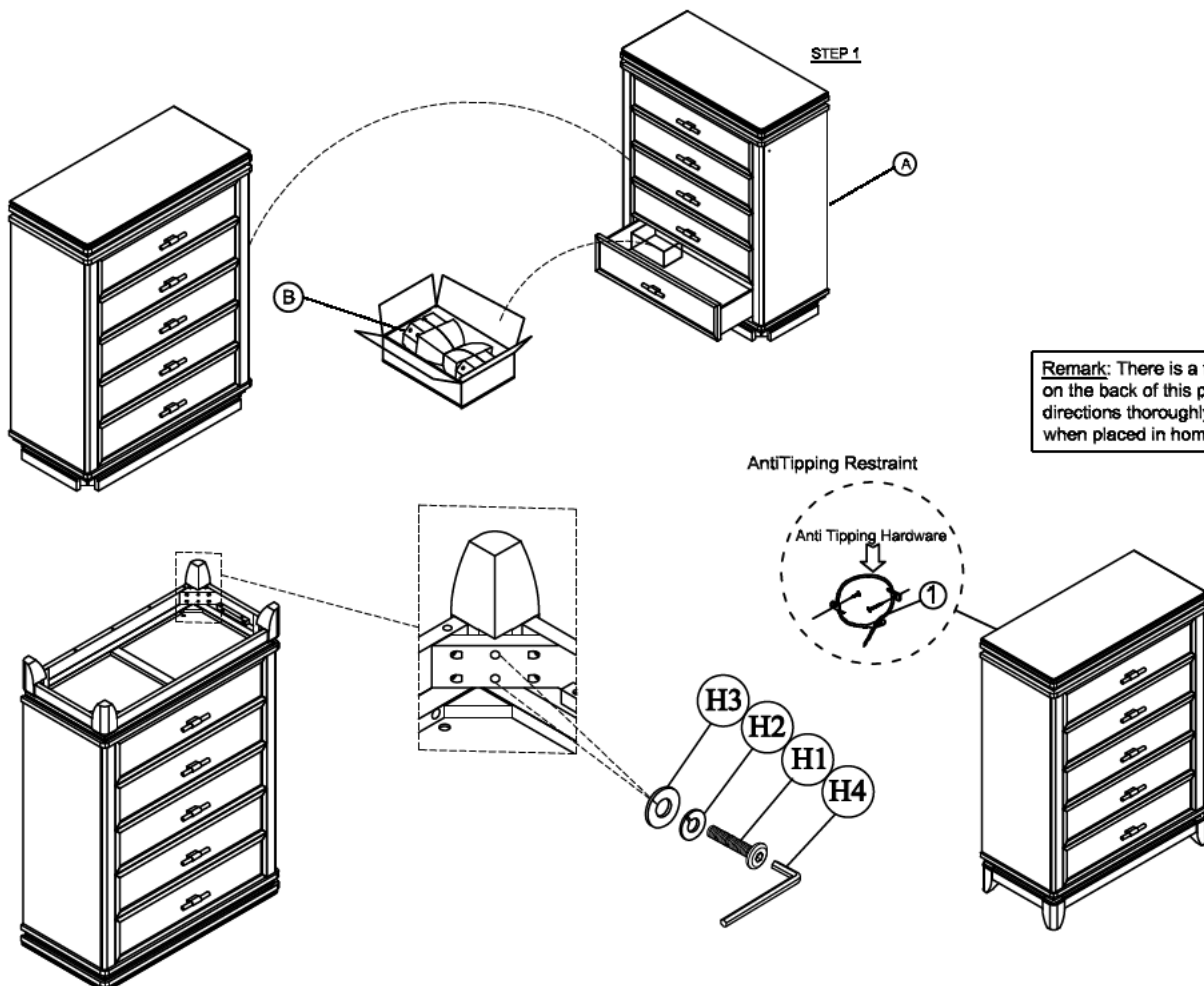



**Remark:** There is a tip restraint kit provided on the back of this product. Please read the directions thoroughly and install immediately when placed in home



STEP 2

# Assembly Instructions For Dresser

**Caution:** Please read instructions thoroughly before unpacking assembly parts. Sharp exposed staple tips can cause injury, therefore, for your protection, please remove any exposed staples used in packing.

- 1 We recommend that you should assemble this product with the assistance of another person; this will make assembly easier, and will help to eliminate damage to the product or injury or person during assembly
  - 2 Be sure to check all packing materials carefully for small parts that may have come loose inside the carton during shipment.
  - 3 Please do not over screw or bolts
  - 4 Please put all parts on a non-abrasive floor before assembly, and follow the assembly steps to assemble your newly purchased product correctly and efficiently
- . Do not allow children to climb on furniture.
  - . Do not place television sets on top of chest, door chest, and/or dressers.
  - . Please place heaviest objects on the lowest drawers.
  - . Please have no more than one drawer open at a time.

No		Parts List	Q'ty
A		Chest	1 Piece
B		Leg	4 Pieces
		Center leg	1 Piece

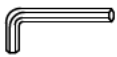
Hardwarelist			
No.	Drawing	Qty.	Description
H1		8	Bolt Ø 1/4" x 50mm
H2		8	Spring washer Ø 1/4"
H3		8	Flat washer Ø 1/4"x19mm
H4		1	Allen Key L57 x4 mm

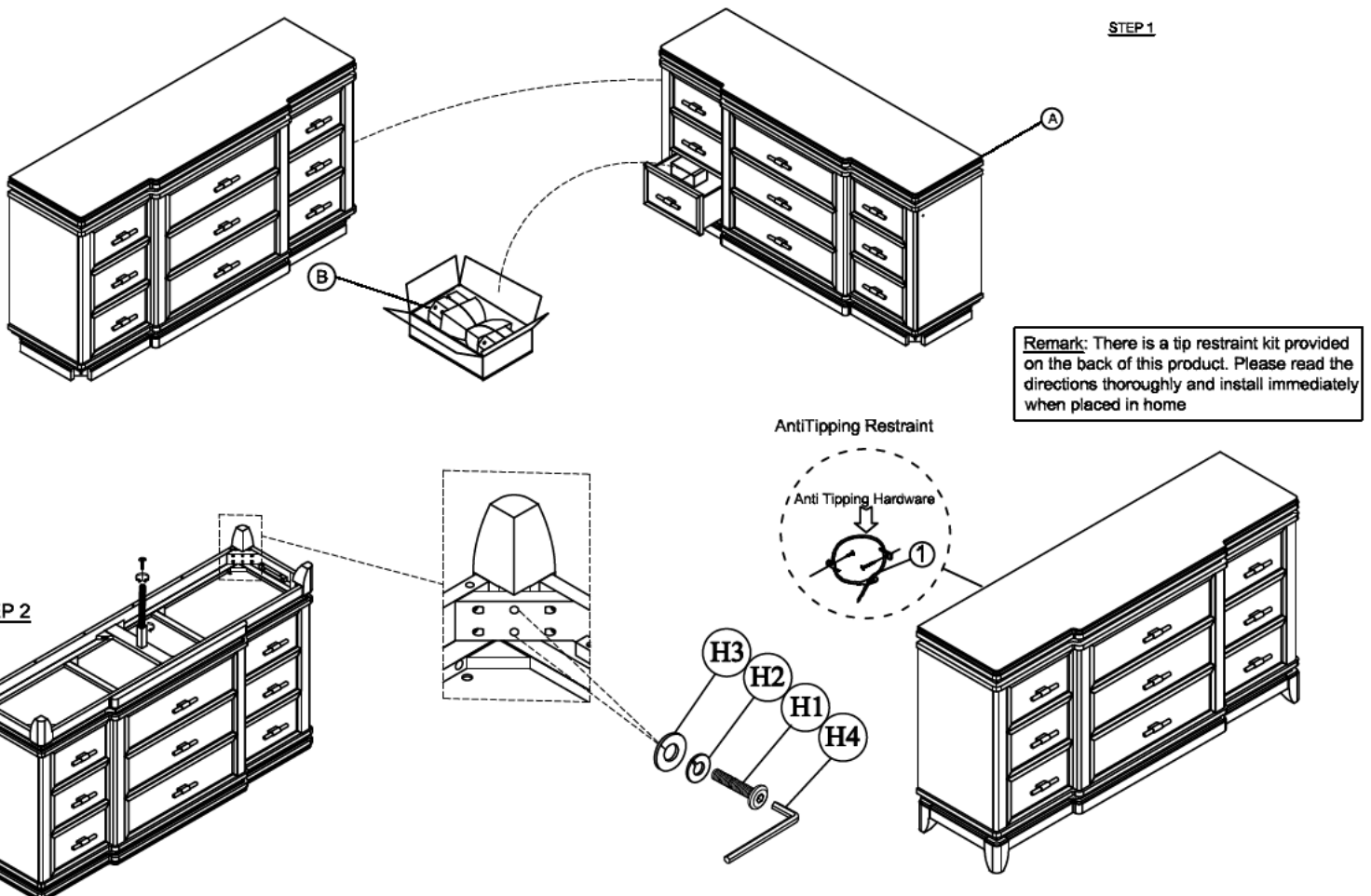







# ASSEMBLY INSTRUCTIONS

## MIRROR

Caution: Please read instructions thoroughly before unpacking assembly pars. Sharp exposed staple tips can cause injury, therefor, for your protection, please remove any exposed staled used in packing.

- 1 We recomend that you should assemble this product with the assistance of another person; this will make assembly easier, and will help to eliminate damage to the product or injury or persons during assembly
  - 2 Be sure to check all packing materials carefully for small parts that may have come loose inside the carton during shipment.
  - 3 Please do not over tighten screw of bolts
  - 4 Please put all parts on a non-abrasive floor before assembly, and follow the assembly steps to assembly your newly purchased product correctly an efficiently
- . Do not allow children to cimb on furniture.
  - . Do not television sets on top of chest, door chest, and/or dressers.
  - . Please place heaviest objects the lowest drawers.
  - . Please have no more than drawer open at a time.

No	Parts List	Q'ty
A	 Mirror Frame	1 Pc
B	 Mirror support	2 Pcs
C	 Dresser	1 Pc

Hardware List Mirror (F 2270-50)			
1		Bolt (Ø1/4" x 38mm)	8 Pcs
2		Sping washer (Ø1/4"x13x1.2)	8 Pcs
3		Flat washer (Ø1/4"x19x2)	8 Pcs
4		Allen Key L57 x4 mm	1 Pc

**Remark: there is a tip restraint kit provided on the back of this product. please read the dircleons thoroughly an Install Immediately when placed In home**

