

Sofa Assembly Instruction

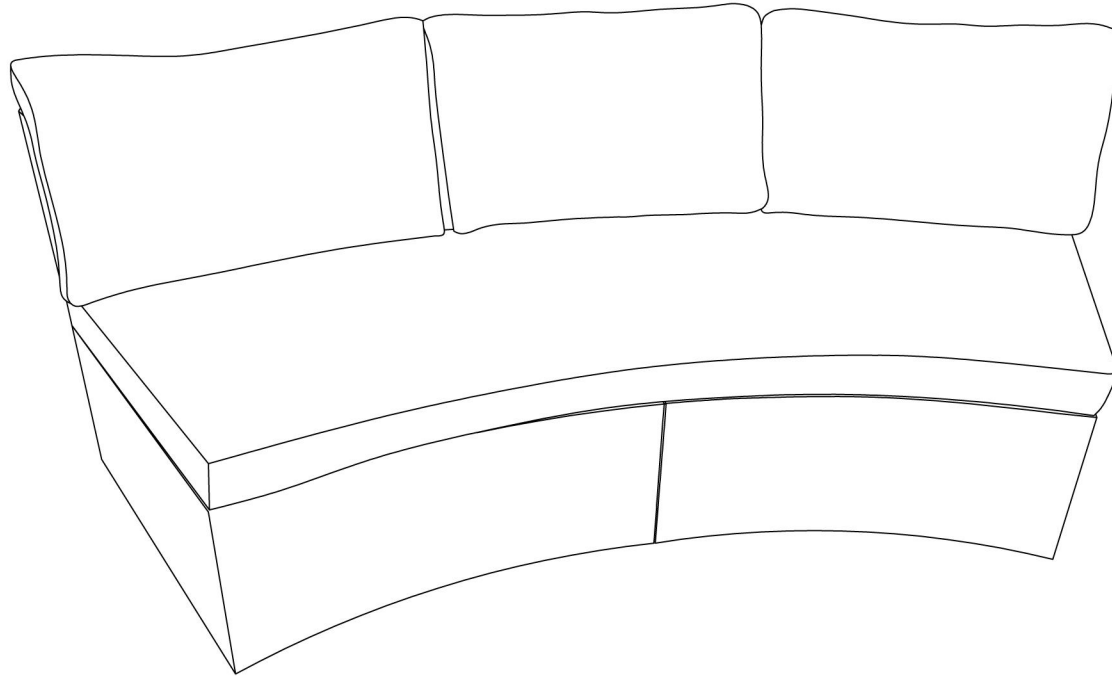

Dear customers,

Thank you for purchasing our product. Please read this instruction manual carefully after receiving this product. It will help you assemble this product quickly, safely and correctly. You can keep this manual for future reference.

SOFA

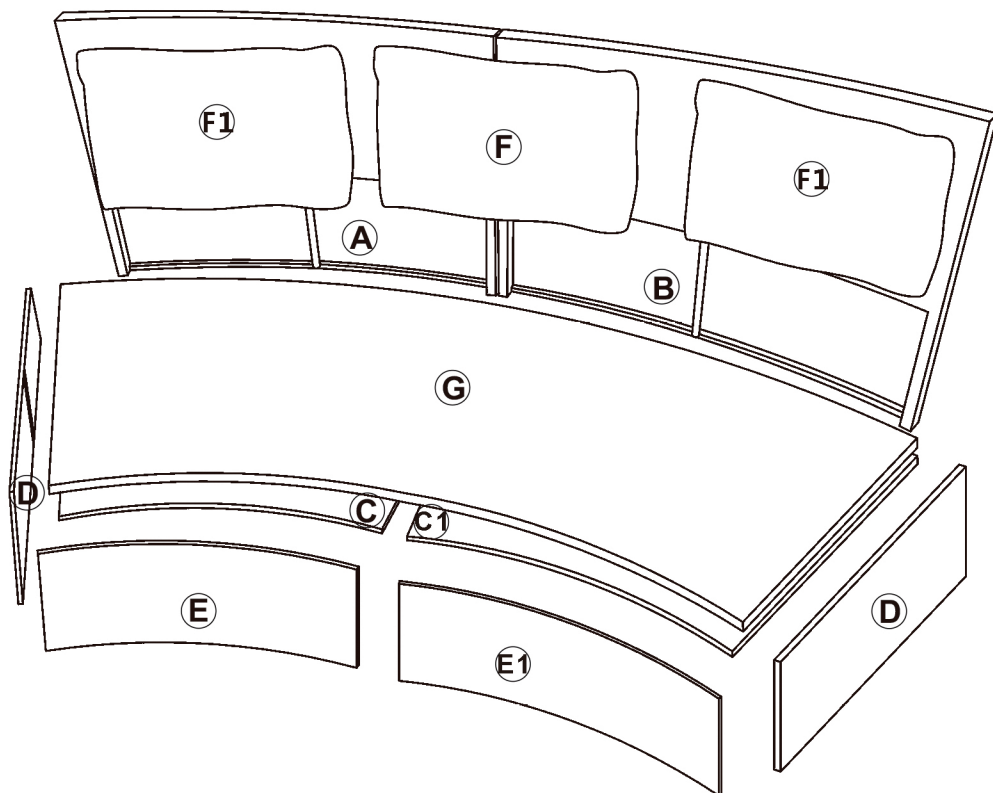

Hardware parts

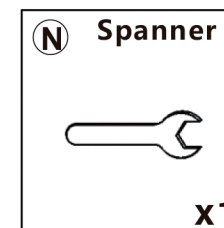
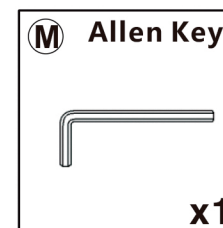
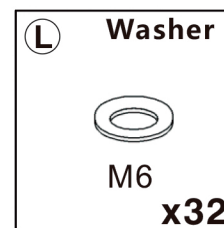
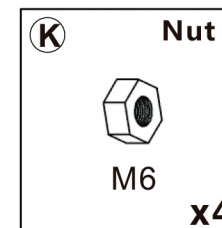
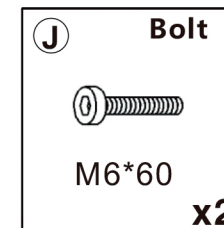
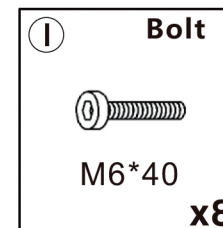
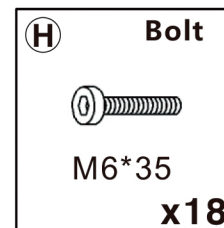

Main structure accessories

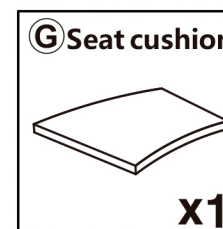
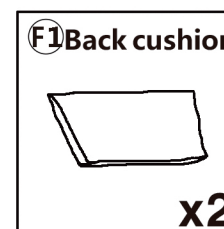
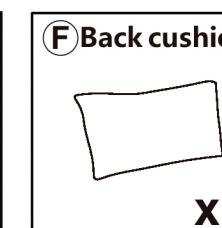
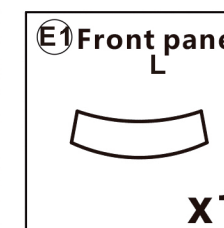
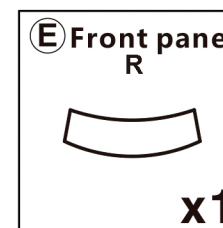
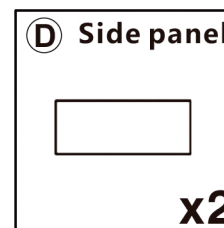
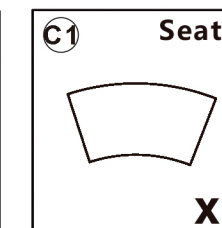
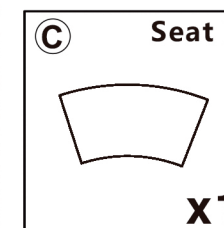
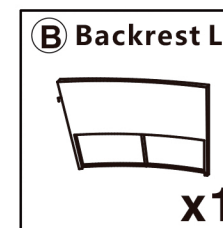
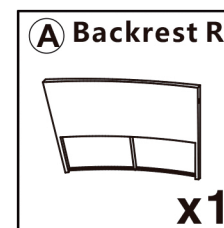



Safety and Care Advice

Important – Please read these instructions fully before starting assembly

Thanks for your purchase. Before the assembly, please follow the instruction to check if all the spare parts and screws are intact.

- Considering the size and weight of the sofa, we recommend two adults to assemble the sofa, on a carpeted or padded area, in the room that it is intended for. Approximate assembly time: 30 minutes.
- Keep all components and packaging out of reach of children or animals to avoid risk of choking or suffocation.
- Please do not throw away any of the packaging or the instruction until you have checked all the components and hardware and the furniture is fully assembled. Please ensure that the packaging is disposed of in a safe and environmentally friendly way.
- Please do not take off the cover, and do not wash.

Your cushions come vacuum packed and sealed for shipping. To restore the cushion's original shape, follow the steps below.

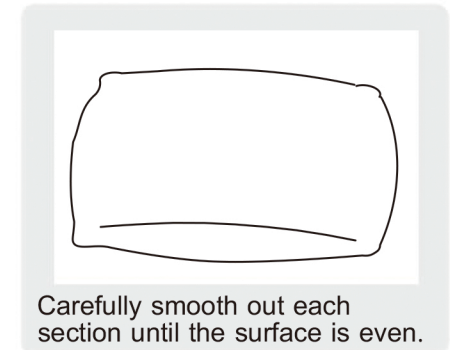
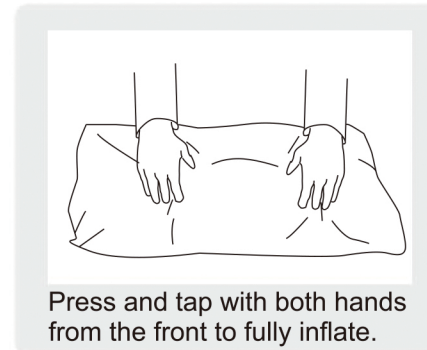
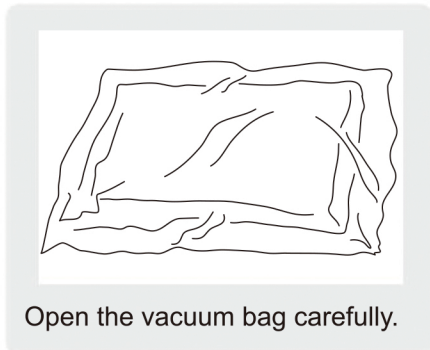

After packing up, place them in somewhere dry and ventilated. After about 72-96hours. It can be restored to the best use condition.

STEP 1

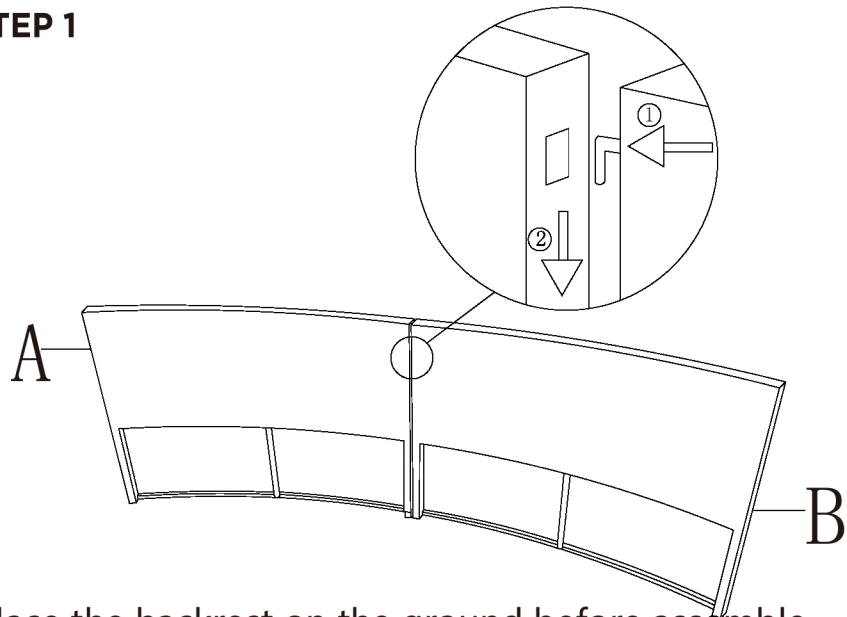

Place the backrest on the ground before assemble.
Please DO NOT tighten the screws at this step yet. Wait to tighten all the screws until the product is fully installed.

STEP 2

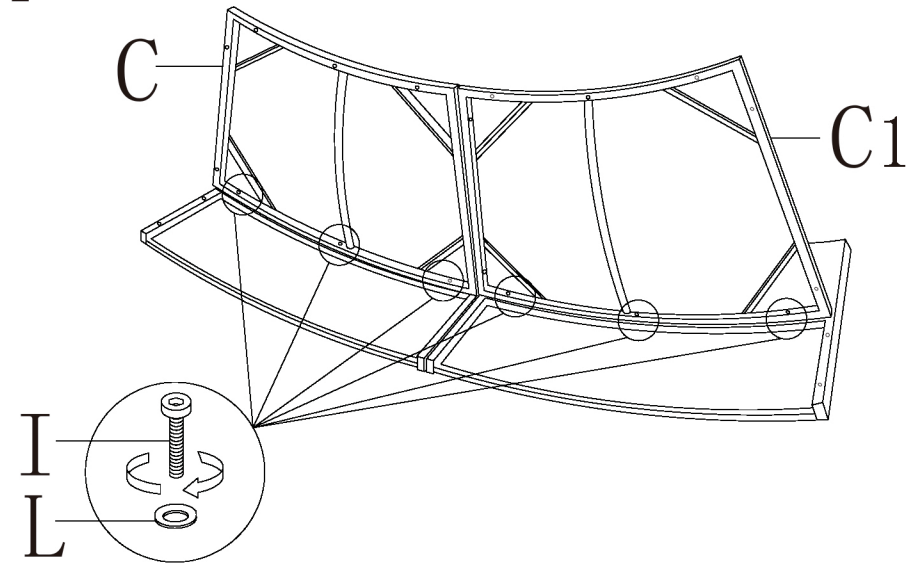

Please DO NOT tighten the screws at this step yet. Wait to tighten all the screws until the product is fully installed.

STEP 3

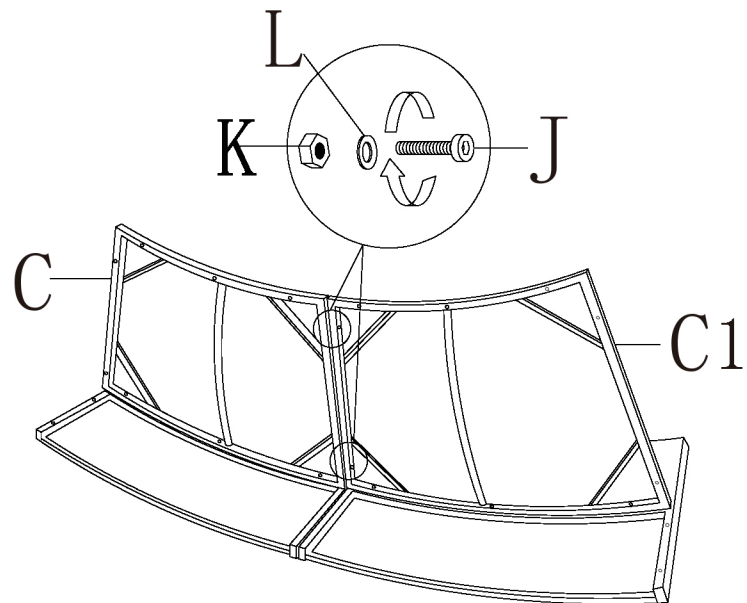

Please DO NOT tighten the screws at this step yet. Wait to tighten all the screws until the product is fully installed.

STEP 4

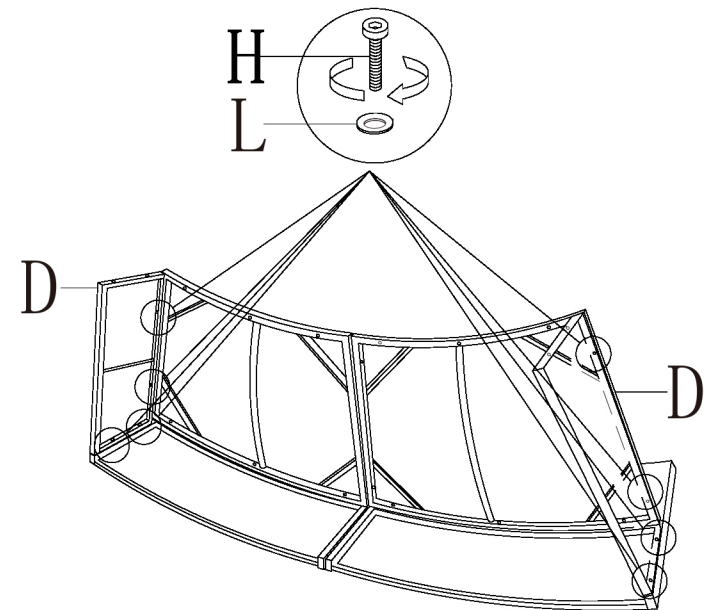

Please DO NOT tighten the screws at this step yet. Wait to tighten all the screws until the product is fully installed.

STEP 5

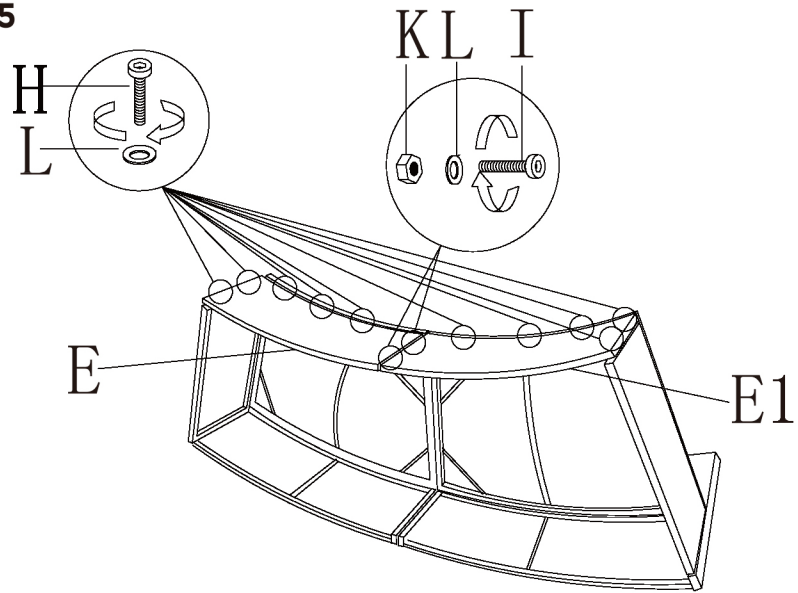

Please DO NOT tighten the screws at this step yet. Wait to tighten all the screws until the product is fully installed.

STEP 6

