

ASSEMBLY INSTRUCTIONS

DECK BOX

SKU: T-PSB24-0646

Patiowell,
Store
Your
Patio Well

www.patiowell.com



 Patiowell

Deck Box
Installation Tutorial

[https://www.patiowell.com/
pages/video-T-PSB24-0646](https://www.patiowell.com/pages/video-T-PSB24-0646)

 saleservice@patiowell.com





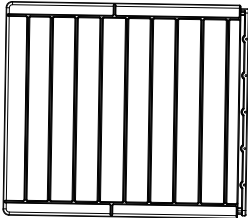
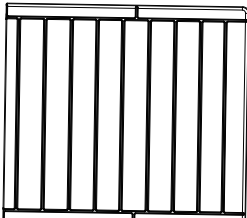
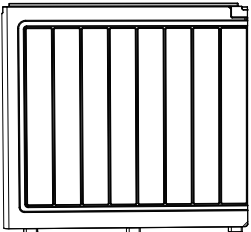
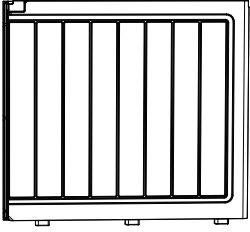
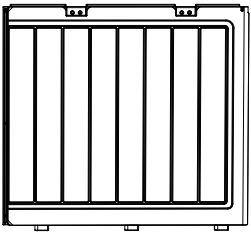
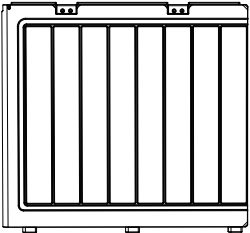
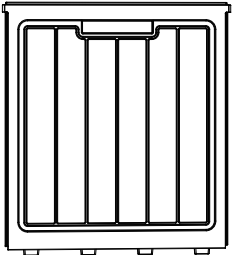
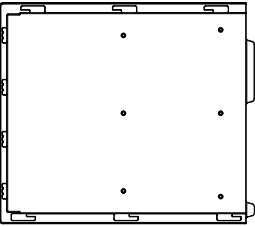
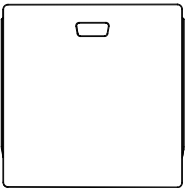
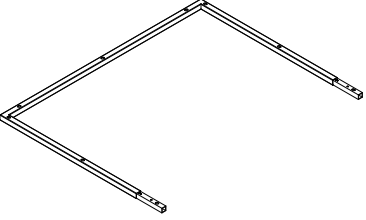



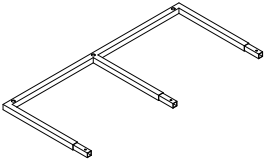
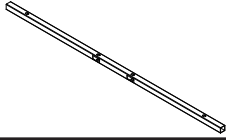
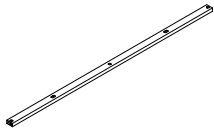
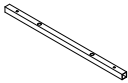

Parts

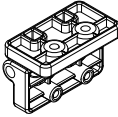
Check and make sure you get the components on the list, contact us for any missing.

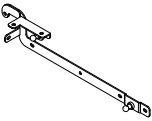
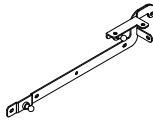
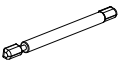
| | | | | | |
|----|---|----|----|---|----|
| E1 |  | X1 | E2 |  | X1 |
| B2 |  | X1 | B1 |  | X1 |
| C1 |  | X1 | C2 |  | X1 |
| D |  | X2 | A |  | X2 |
| F |  | X1 | E3 |  | X2 |

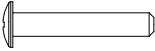
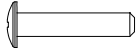
Parts

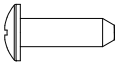
Check and make sure you get the components on the list, contact us for any missing.

| | | | | | |
|----|--|-----|----|--|-----|
| A1 |  | X2 | E4 |  | X2 |
| | | | E5 |  | X2 |
| A2 |  | X3 | B3 |  | X2 |
| H |  | X4 | C3 |  | X4 |
| D1 |  | X1 | D2 |  | X1 |
| D3 |  | X2 | G |  | X1 |
| S1 |  M5*30 | X22 | S2 |  M5*25 | X6 |
| S3 |  M5*16 | X20 | S4 |  M6*20 | X12 |
| S5 |  M6*20 | X19 | S6 |  M4*12 | X4 |
| S7 |  M4.2*13 | X6 | | | |

Assembly steps

Step 1

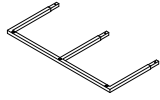

A1 (X2)



A2 (X3)



S7 (X6)

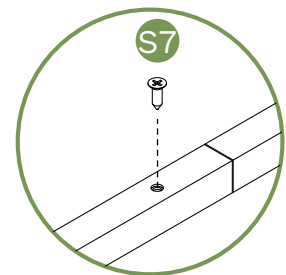
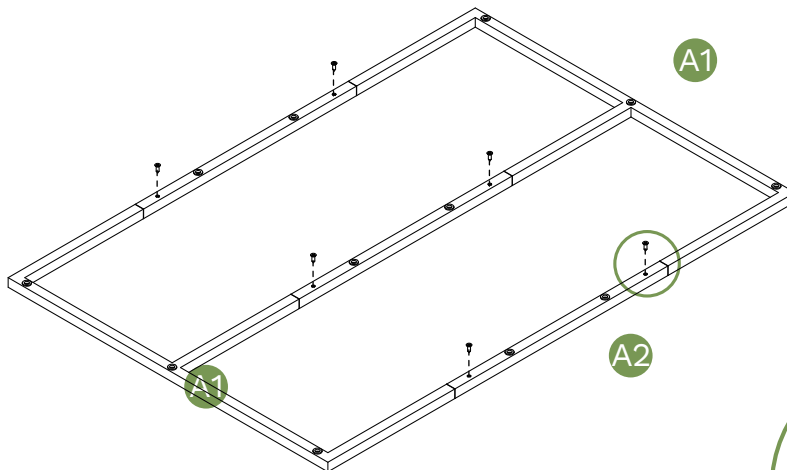
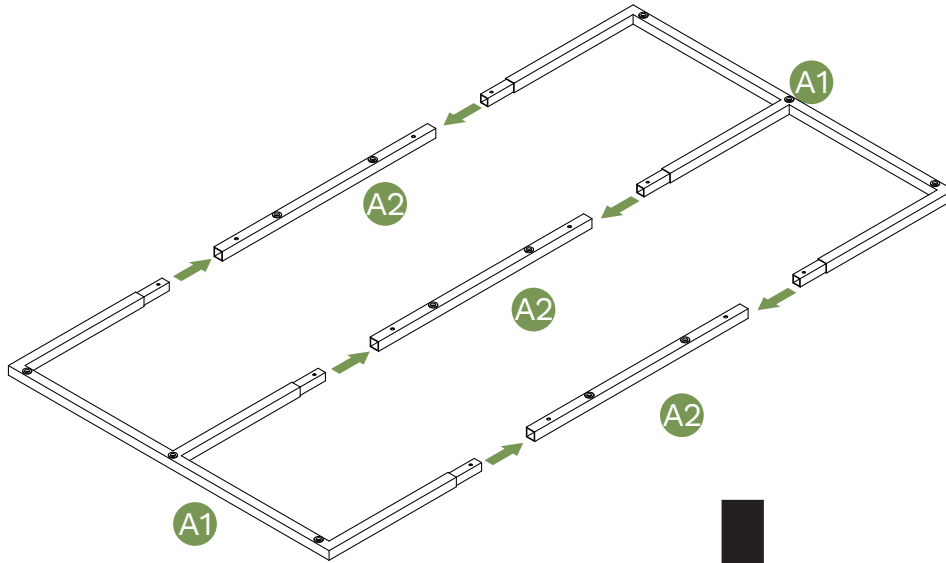

Assembly steps

Step 2

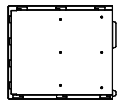

A (X2)

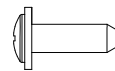

S4 (X12)

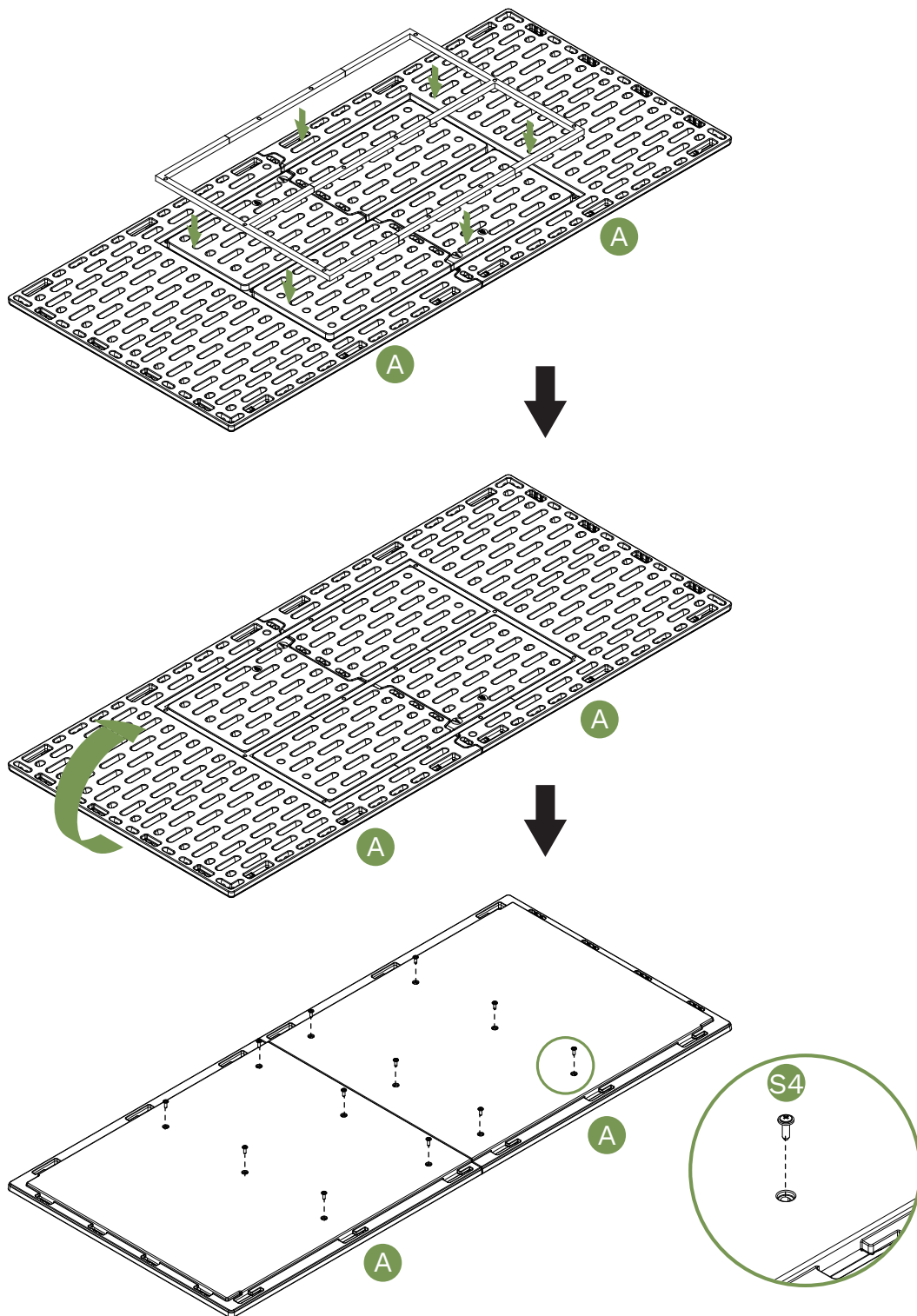

Assembly steps

Step 3



C1 (X1)

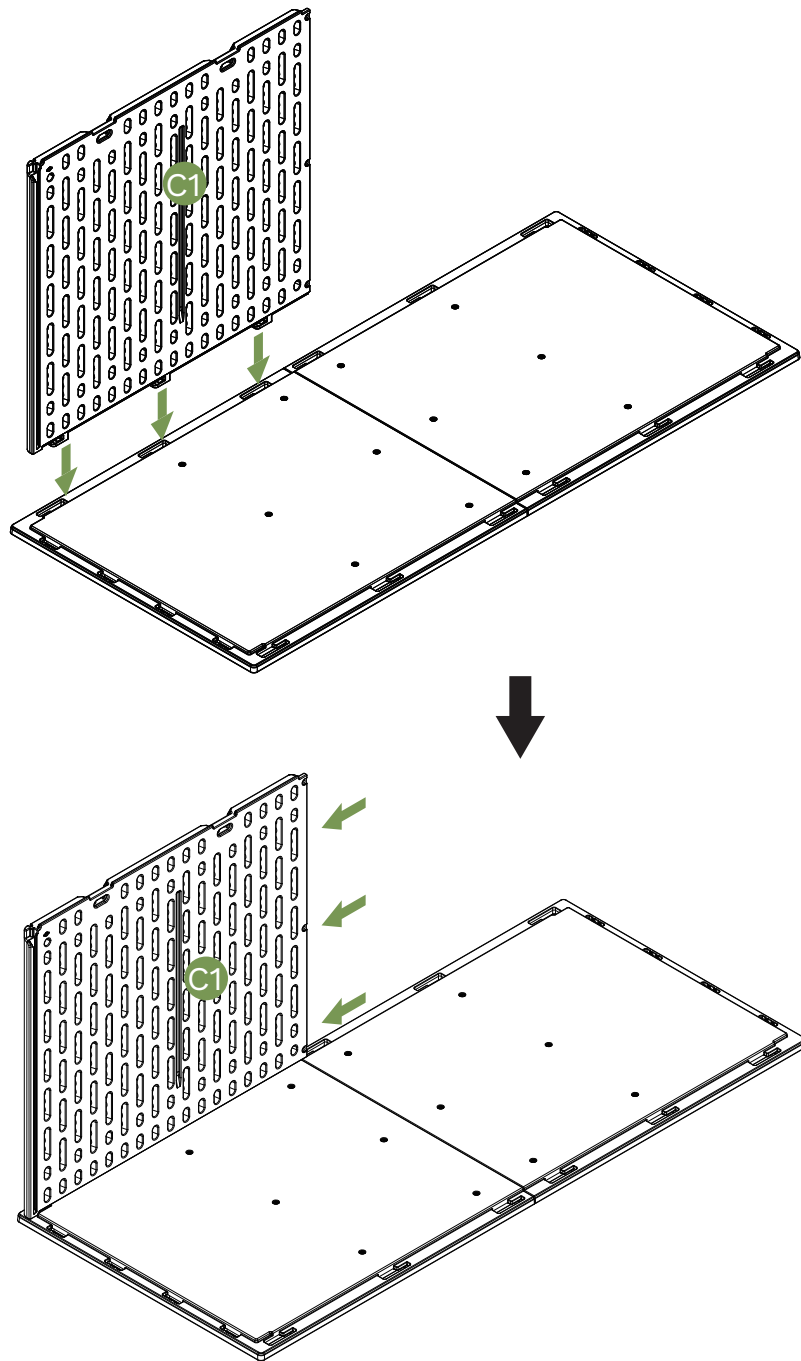

Assembly steps

Step 4

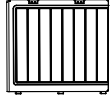

C2 (X1)

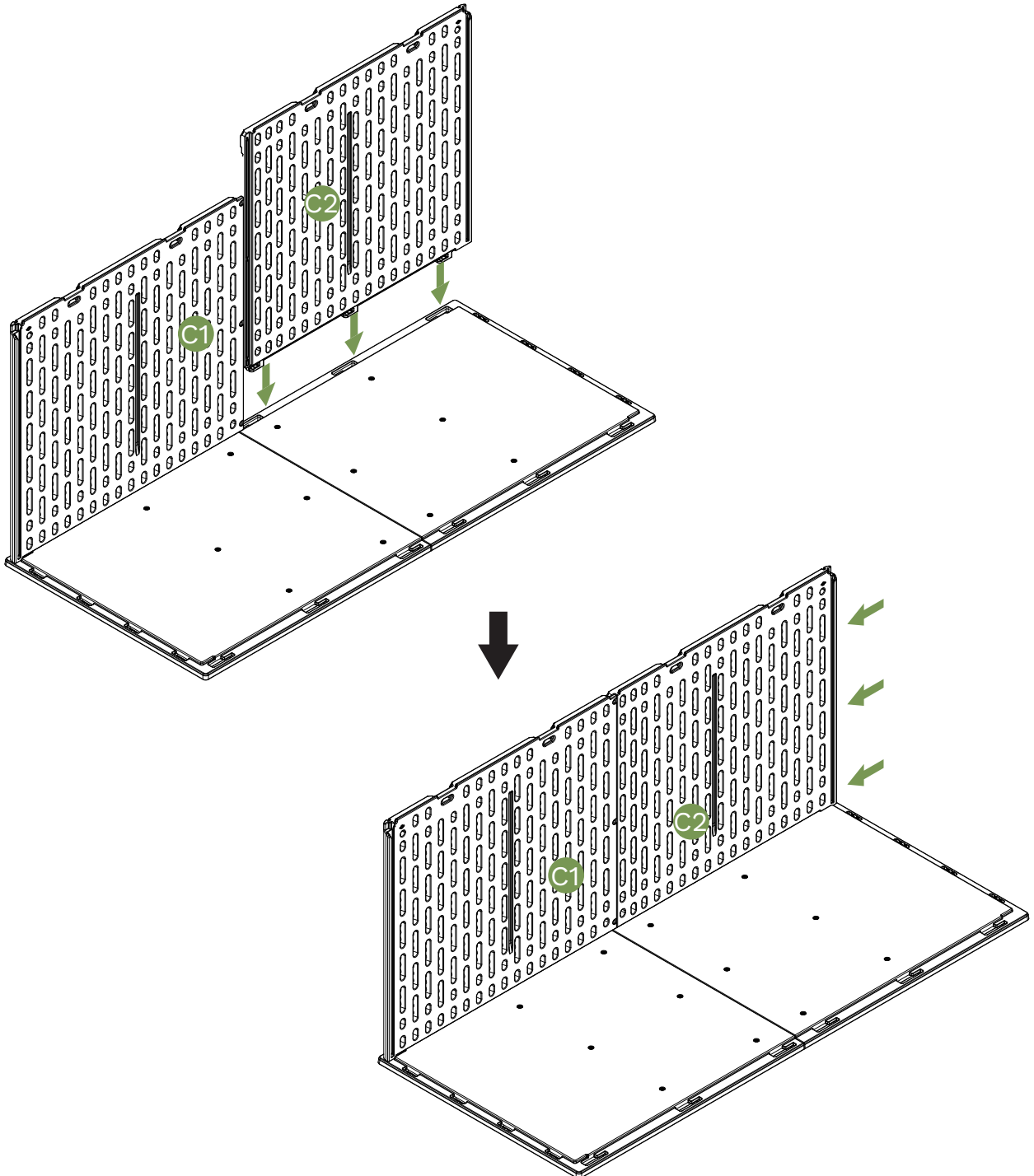

Assembly steps

Step 5

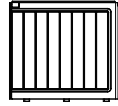

B1 (X1)

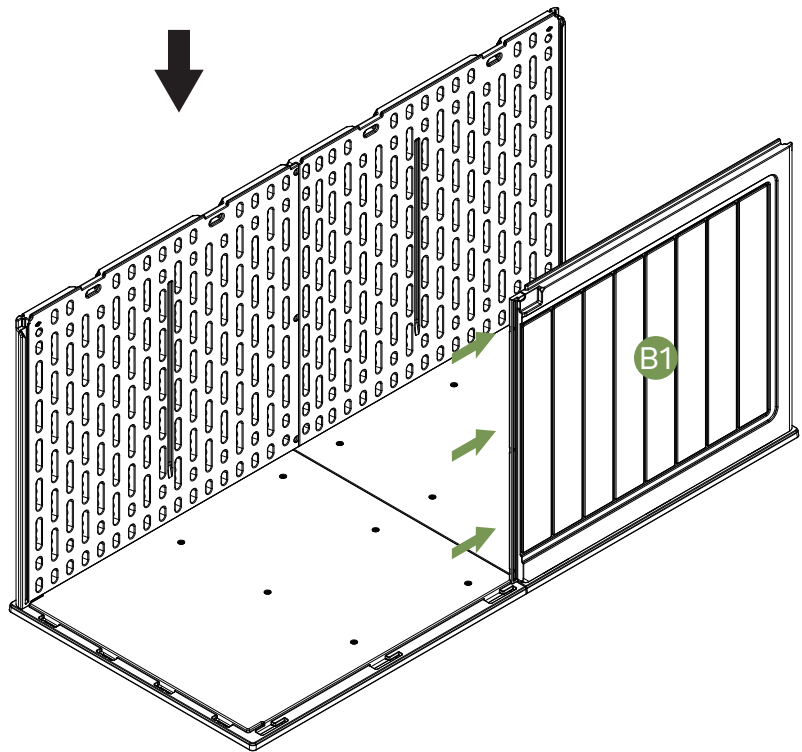
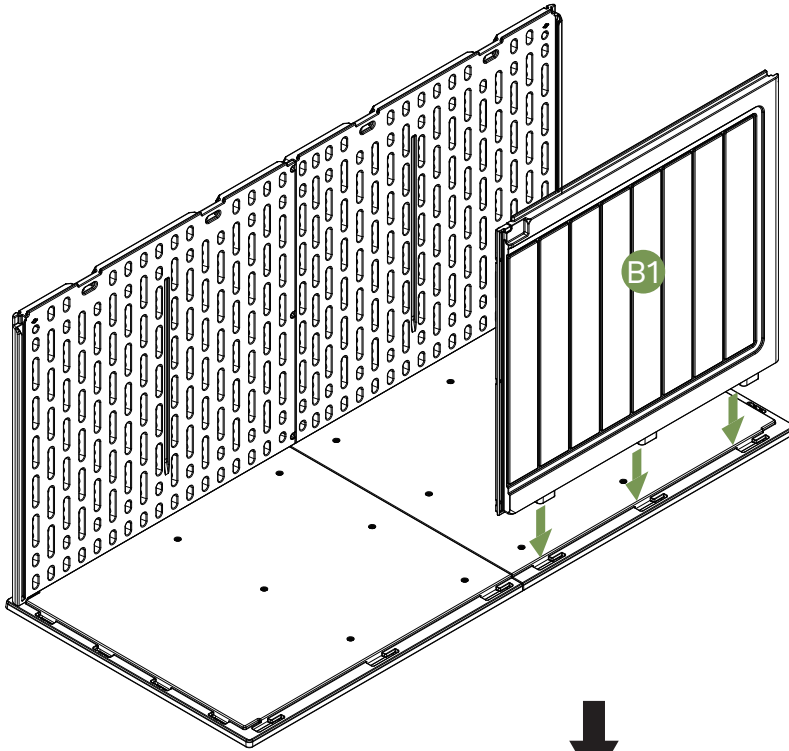

Assembly steps

Step 6

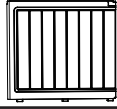

B2 (X1)

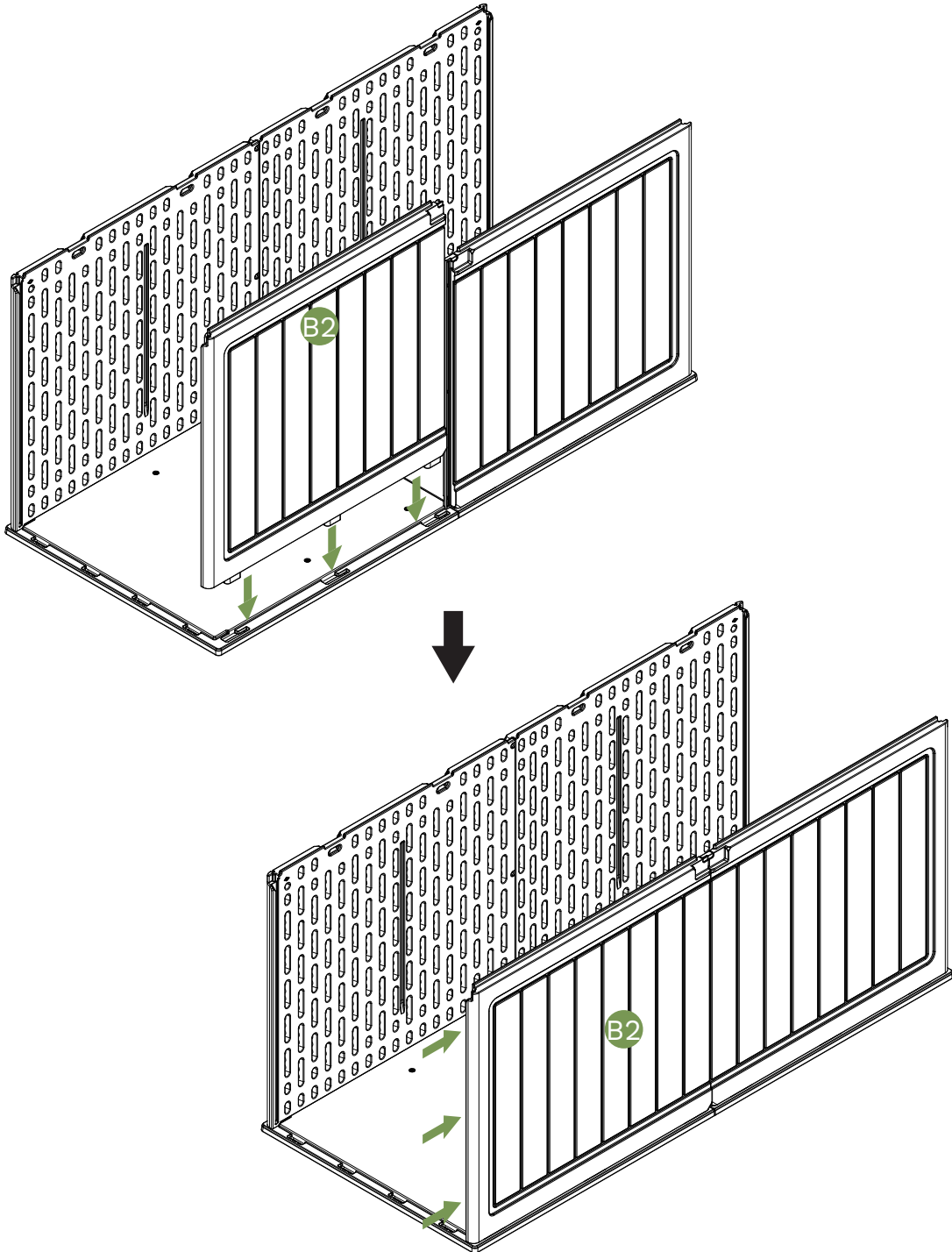

Assembly steps

Step 7

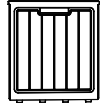

D (X2)

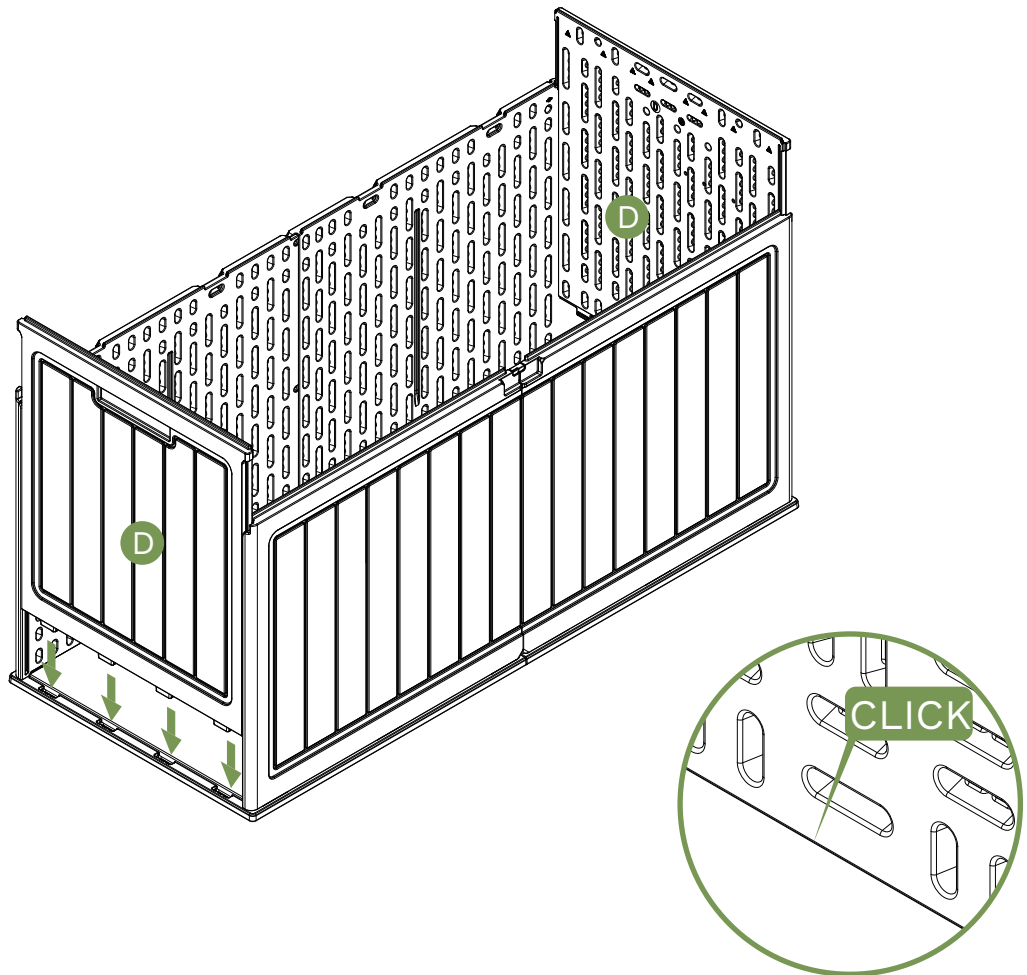

Assembly steps

Step 8

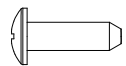

S5 (X6)

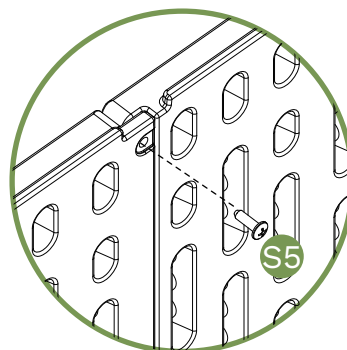
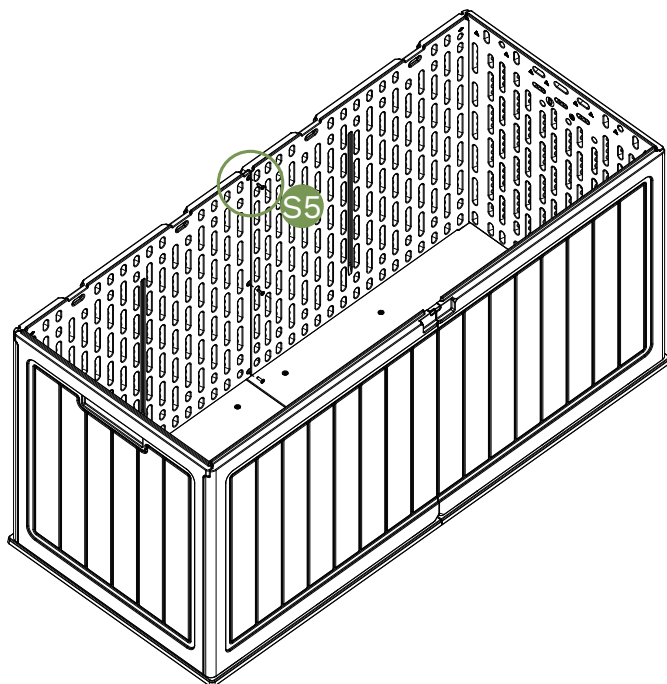
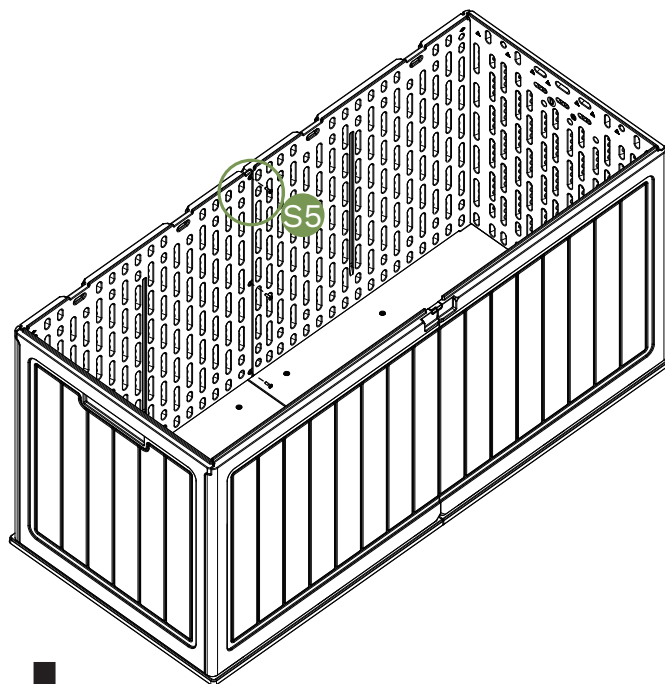
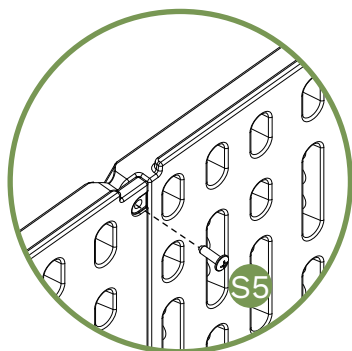

Assembly steps

Step 9



B3 (X1)



G (X1)



S6 (X4)

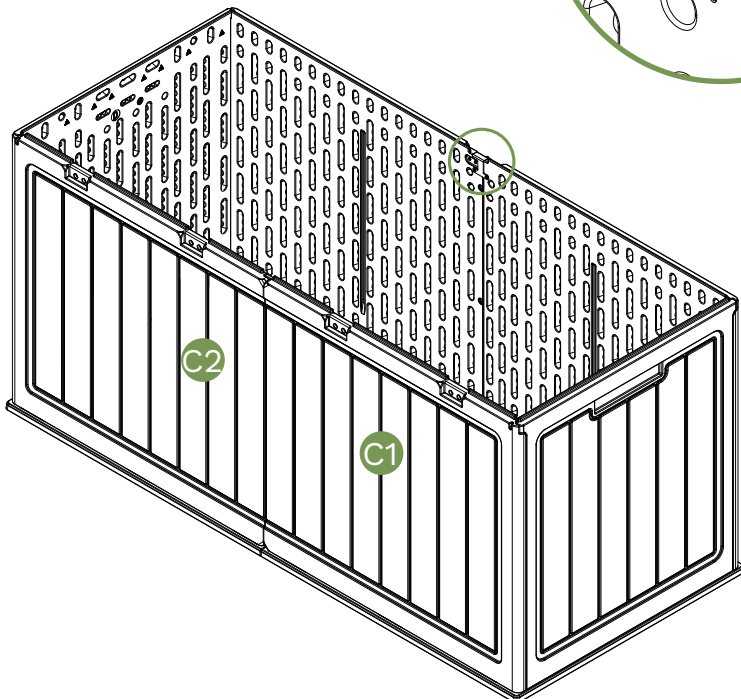
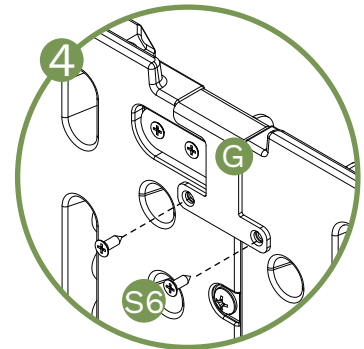
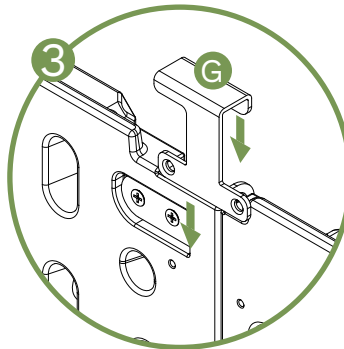
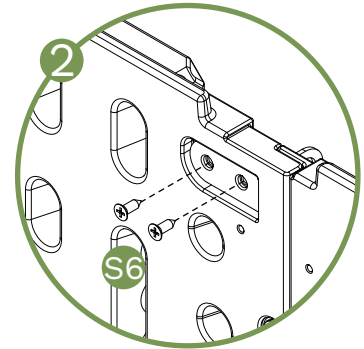
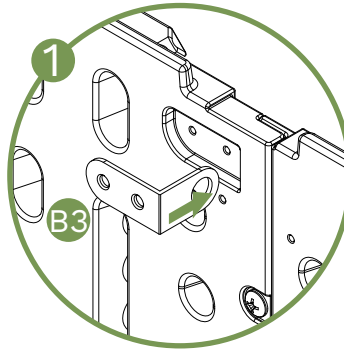

Assembly steps

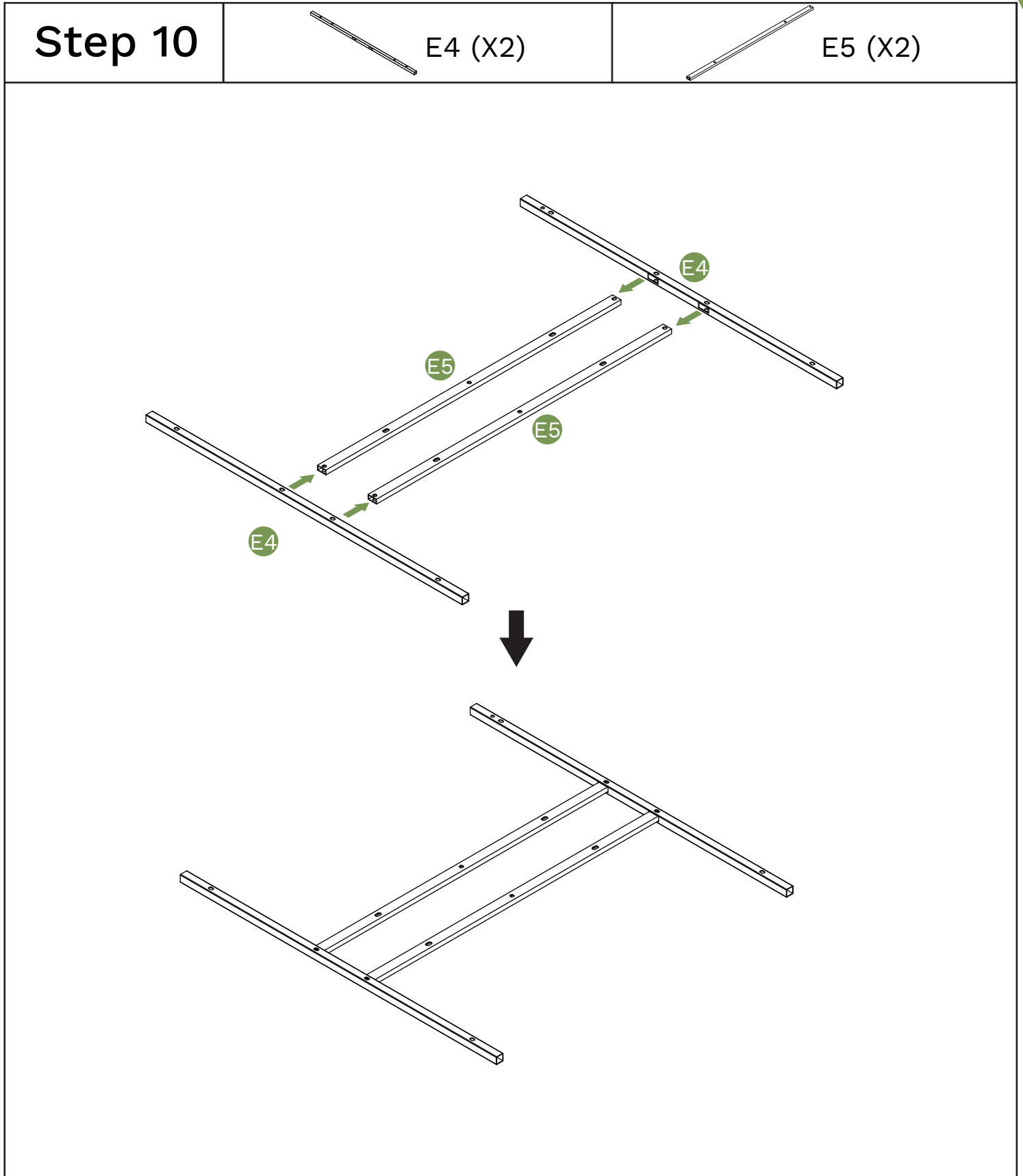

Assembly steps

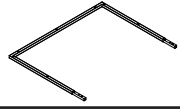

Step 11

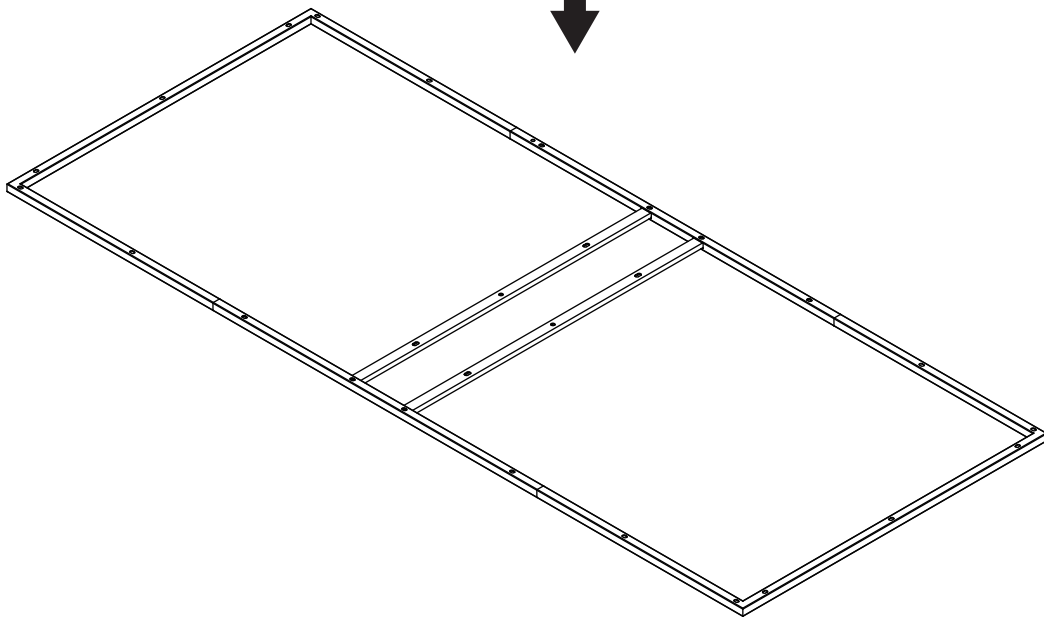
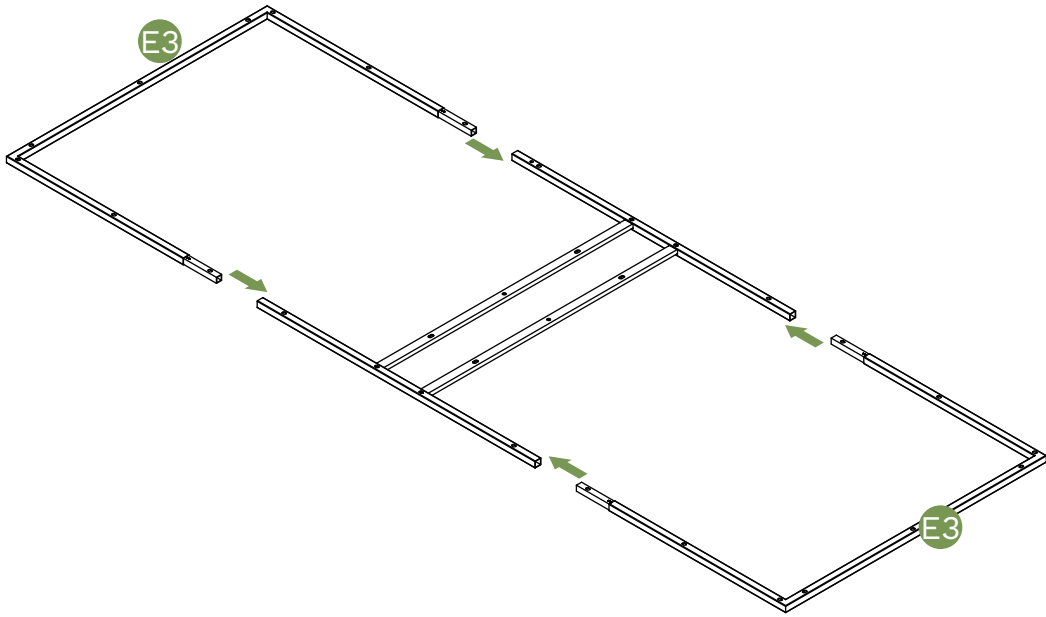

E3 (X2)



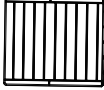
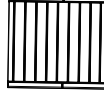
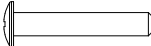
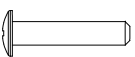

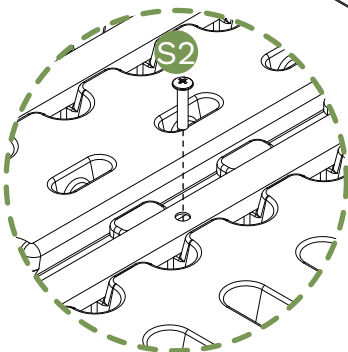
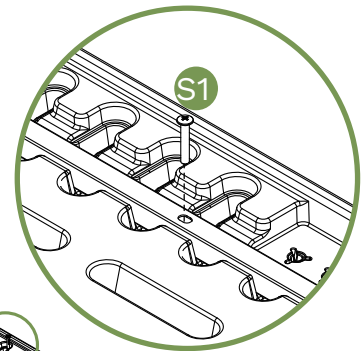
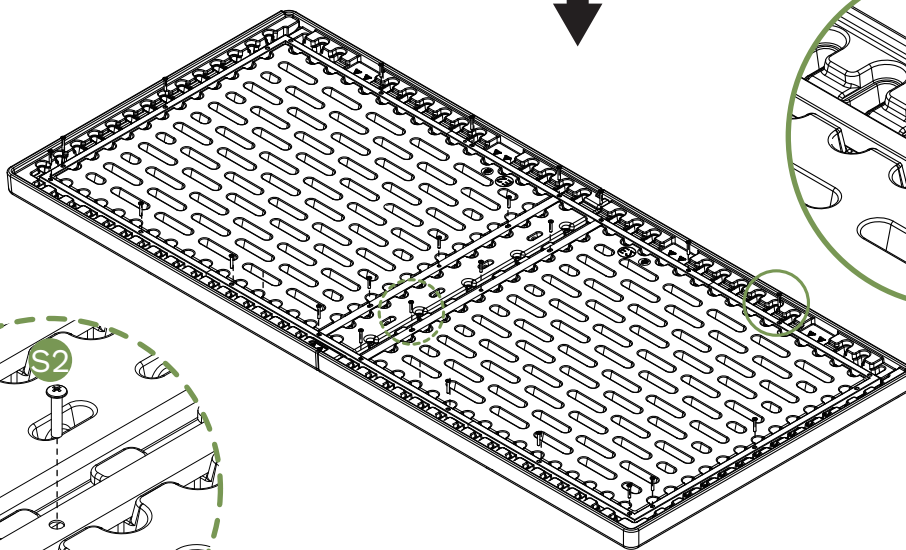
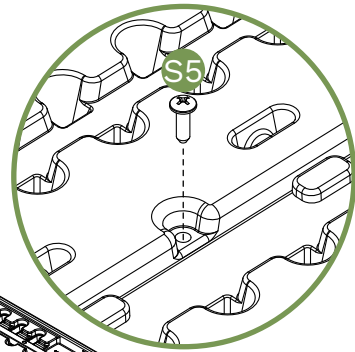
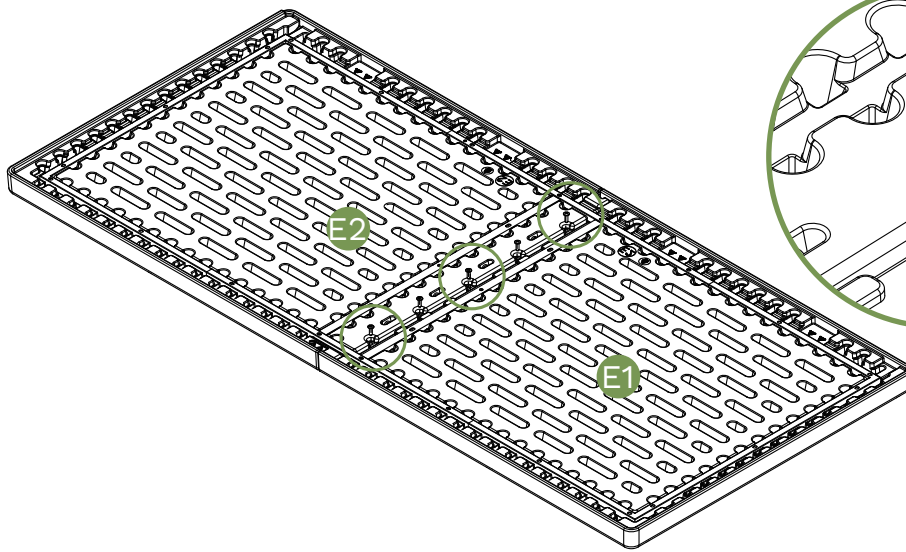

Assembly steps

| | | | |
|----------------|---|---|--|
| Step 12 |  E1 (X1) |  E2 (X1) |  S1 (X18) |
| |  S2 (X4) |  S5 (X3) | |

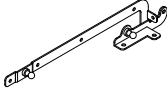
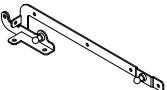
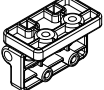

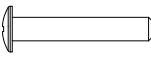
Assembly steps

| | | | |
|----------------|---|---|--|
| Step 13 |  D1 (X1) |  D2 (X1) |  H (X4) |
| |  B3 (X1) |  S1 (X4) |  S3 (X10) |

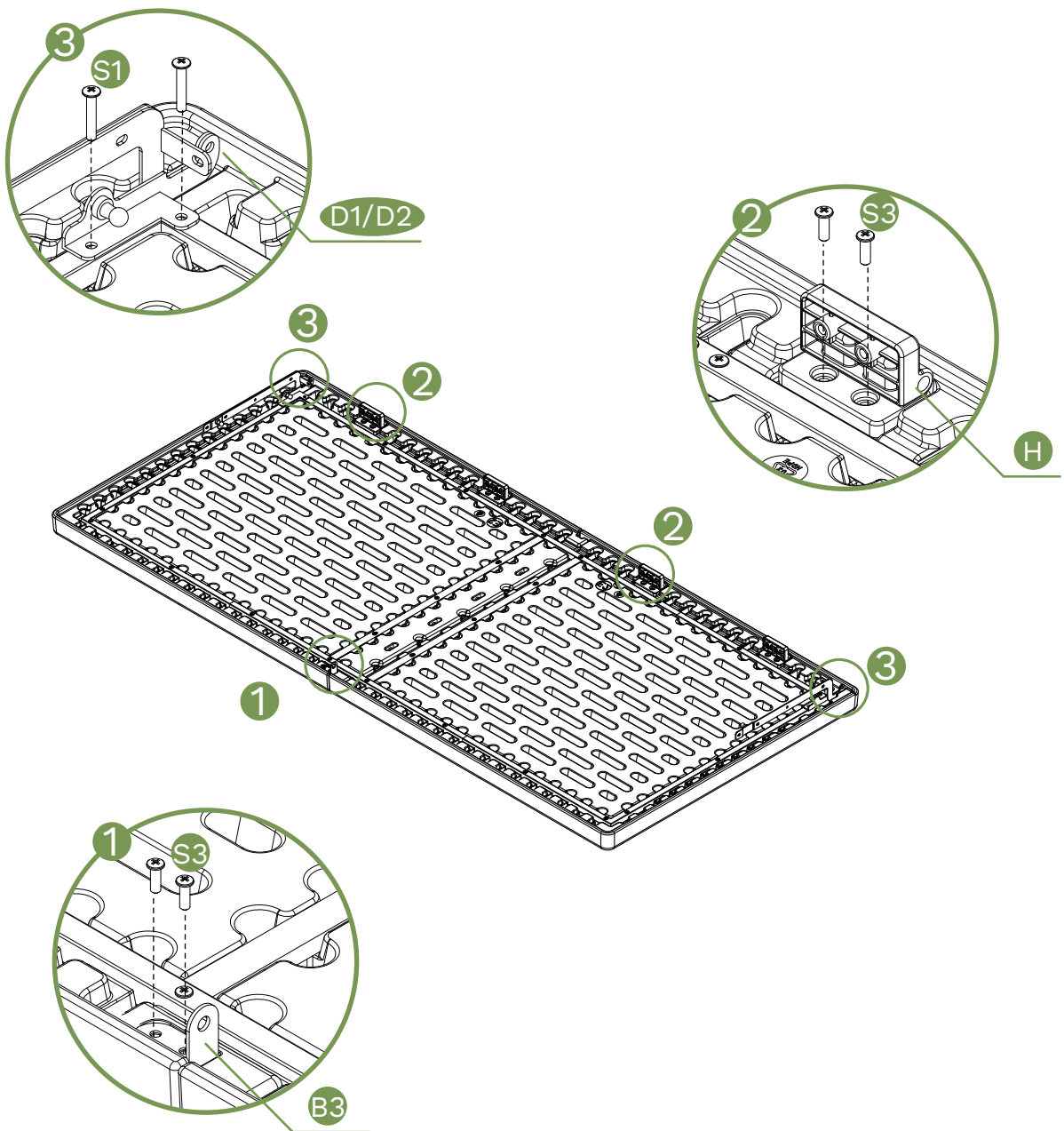

Assembly steps

Step 14



C3 (X4)



S3 (X10)

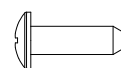

S5 (X8)

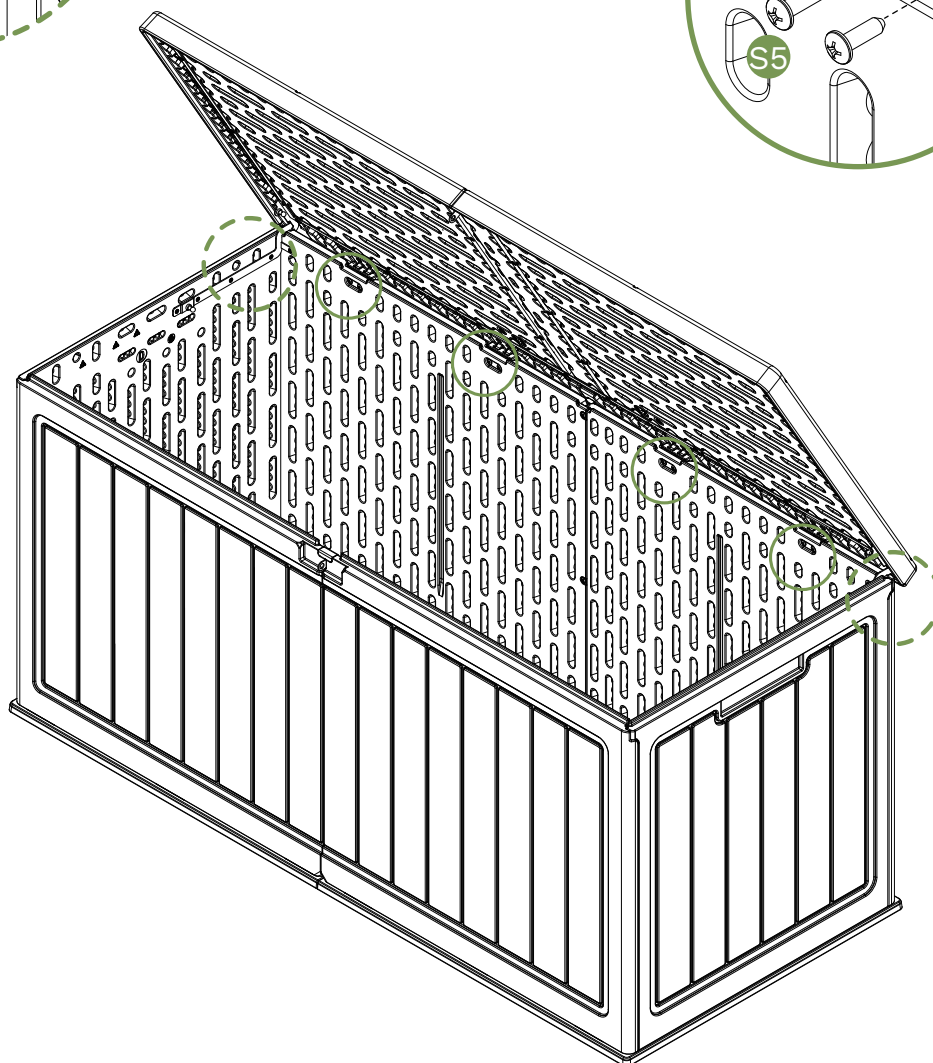
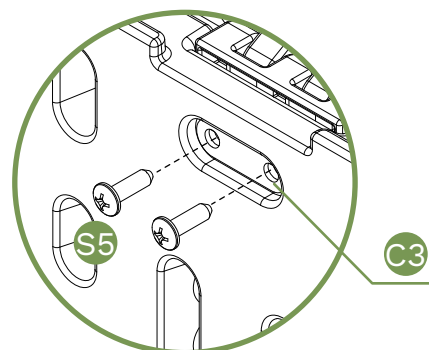
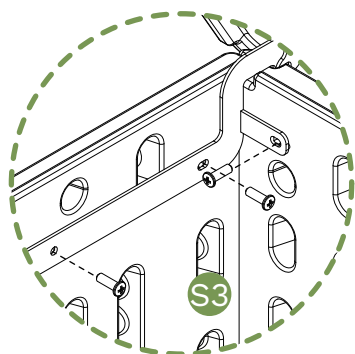

Assembly steps

Step 15

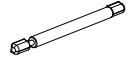

D3 (X2)

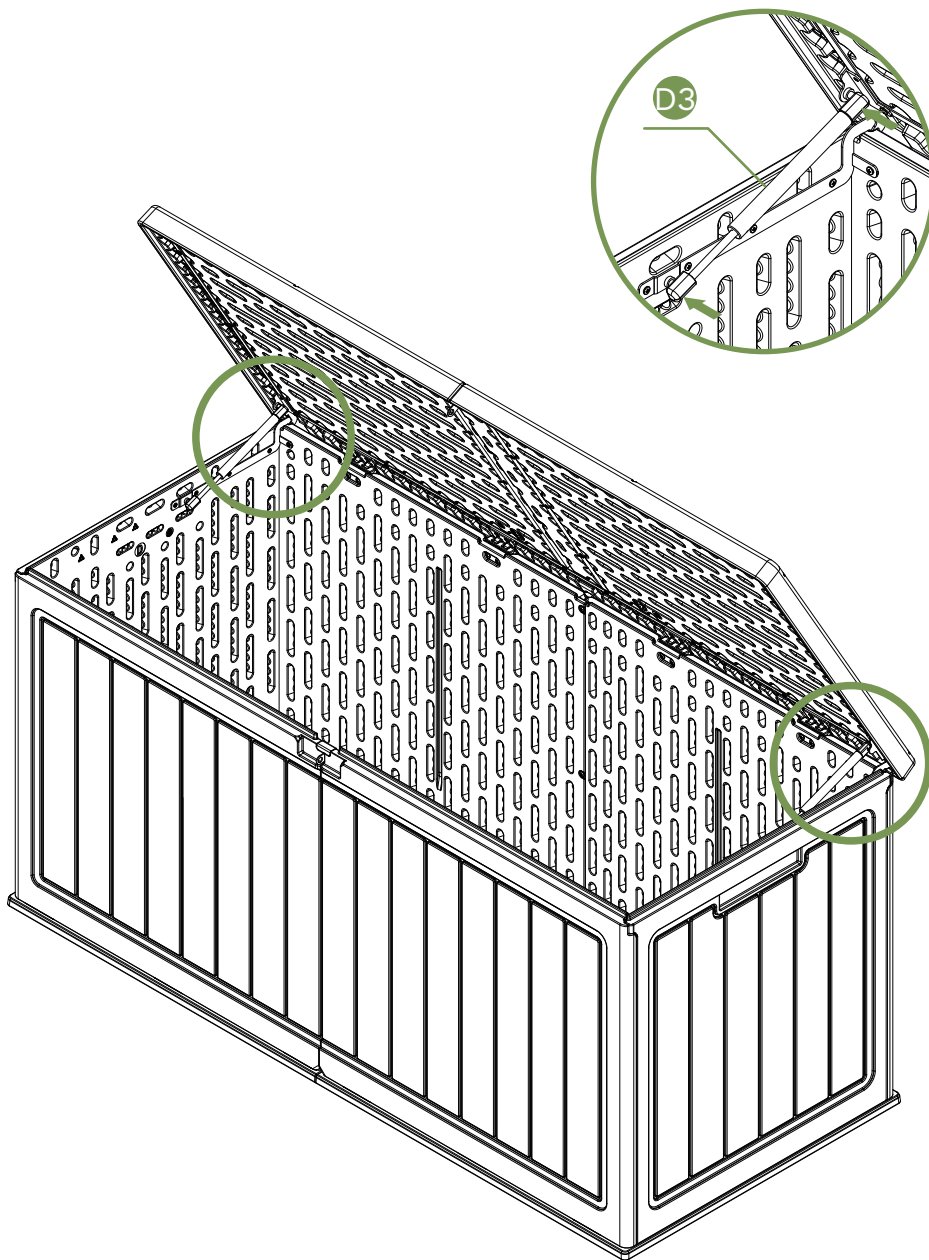

Assembly steps

Step 16

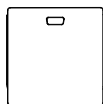

F (X1)

