

# ASSEMBLY INSTRUCTION

**W**e believe you will absolutely love your new furniture. Please immediately examine this product carefully. Any request for missing part or damage replacement must be received within 90 days of your receipt of the product.

## **90-Day Limited Warranty Statement for Manufacturing Defects**







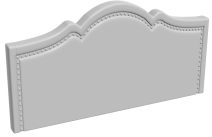
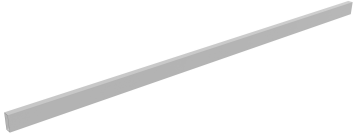

Please read this Limited Warranty carefully. To maintain your Warranty, you will need to comply with the conditions stated here. This warranty is for manufacturing defects only and does not cover damages as a result of misuse.

1. Our products sold comply with the description contained in this Warranty. All parts and products are warranted 90-Day from the original date of delivery except: parts and products used for commercial, contract, rental trade, institutional, or any other non-residential purposes; parts and products that have not been maintained in accordance with the care recommendations provided; parts and products damaged resulting from the consumer's improper assembly; or parts and products that are damaged or defective due to normal wear and tear.
2. To exercise rights under this warranty, proper documentation, i.e., photography, purchase order number, manufacturer's bar code label, and or any other pertinent information upon request is required. We reserve the right to repair or replace the product within the warranty period based upon the documentation received as support of a claim for consideration. We will not replace or repair any product if improper maintenance, improper handling, or improper use caused the damage. Any product sold from or modified by a Non-Authorized Dealer, Seller or Consumer will void the Warranty.
3. Cost of packaging and shipping to and from us is not covered by the warranty unless expressly arranged by us. This warranty does not extend to furniture that has been exchanged or replaced by us as settlement of an original claim of defective merchandise. This warranty does not extend to furniture that has been moved from delivery location on original purchase order.

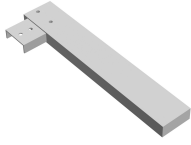
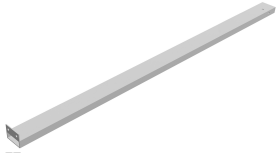

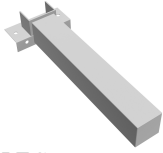



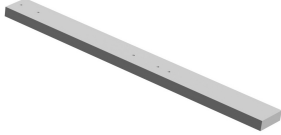

We appreciate your business!

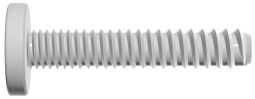
# ASSEMBLY INSTRUCTION

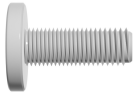
## PARTLIST

<p>1</p>  <p>HEADBOARD CUSHION x1</p>	<p>2</p>  <p>FOOTBOARD METAL TUBE x1</p>	<p>3</p>  <p>FOOTBOARD LEG (R) x1</p>	<p>4</p>  <p>FOOTBOARD LEG (L) x1</p>
<p>5</p>  <p>SIDE RAIL x2</p>	<p>6</p>  <p>SIDE RAIL x2</p>	<p>7</p>  <p>SIDE RAIL LEG x2</p>	<p>8</p>  <p>SLAT x12</p>
<p>9</p>  <p>SOCKET x24</p>	<p>10</p>  <p>SUPPORT RAIL x2</p>	<p>11</p>  <p>HEADBOARD LEG x2</p>	

## HARDWARE

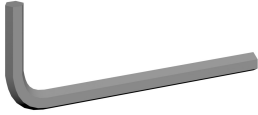
<p>A</p>  <p>JCBB SCREW M8 x 50MM x4</p>	<p>B</p>  <p>JCBC SCREW M6 x 15MM x20</p>	<p>C</p>  <p>JCBC SCREW M6 x 35MM x4</p>	<p>D</p>  <p>SPRING WASHER M6 x 12MM x4</p>	<p>E</p>  <p>FLAT WASHER M6 x 19MM x4</p>
<p>F</p>  <p>SPRING WASHER M8 x 13MM x4</p>	<p>G</p>  <p>FLAT WASHER M8 x 22MM x4</p>	<p>H</p>  <p>L - KEY M4 x 100MM x1</p>	<p>I</p>  <p>L - KEY M5 x 65MM x1</p>	

# ASSEMBLY INSTRUCTION

## STEP 1

Open zipper to get all other parts.

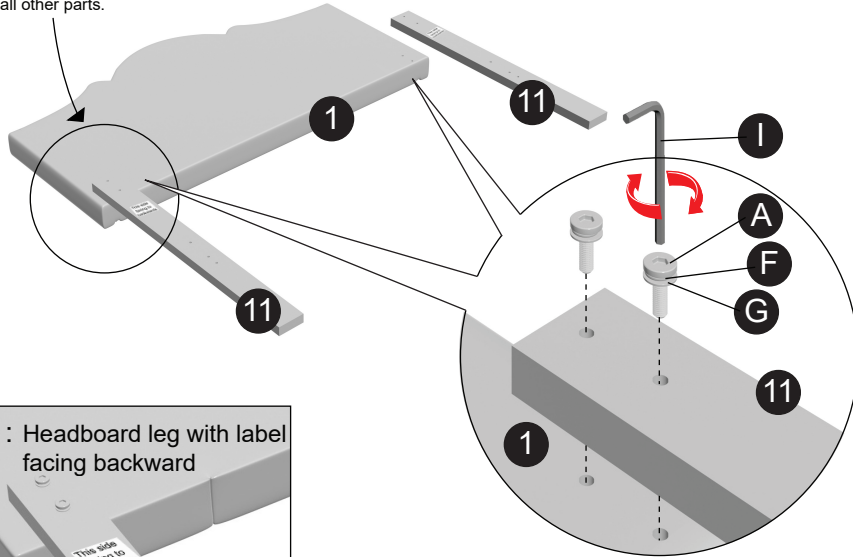

REMARK : Headboard leg with label facing backward

This side facing to backwards

## STEP 2

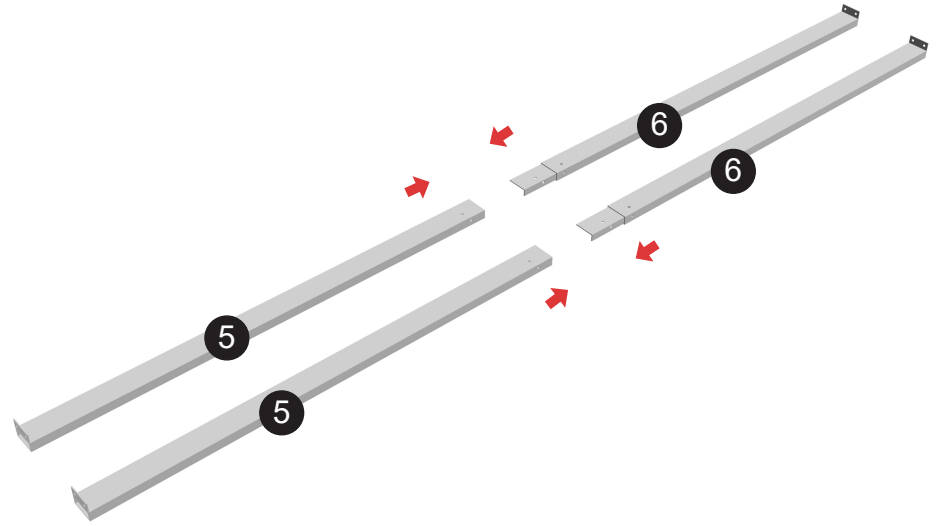

## STEP 3

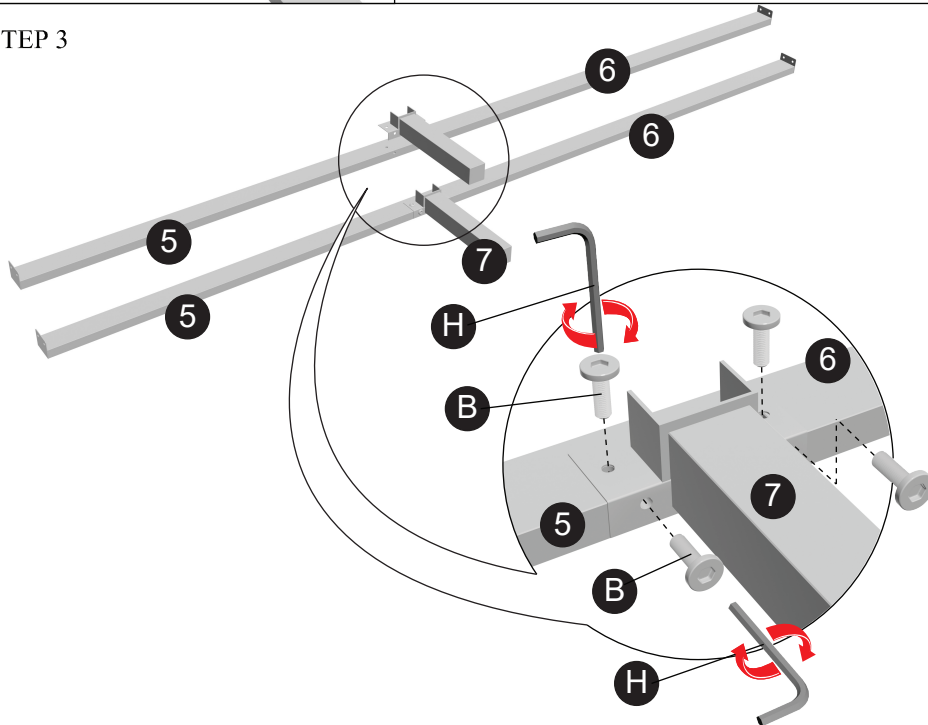

## STEP 4

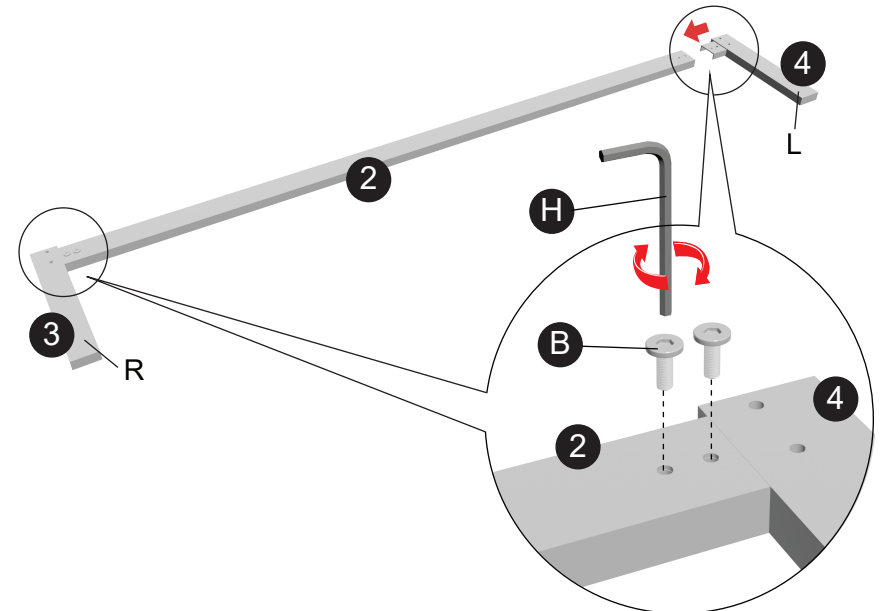



# ASSEMBLY INSTRUCTION

STEP 9

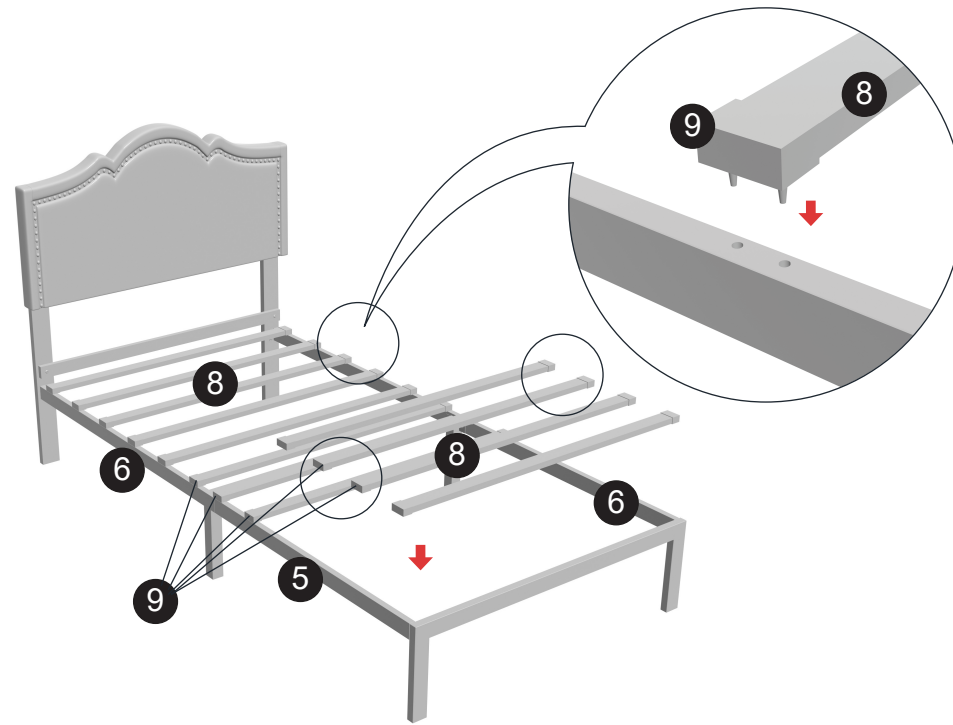

STEP 11



ASSEMBLY  
COMPLETED