



**INSTRUCTIONS D'ASSEMBLAGE  
ASSEMBLY INSTRUCTIONS**

---

---

**ETAGERE -  
72"H / METAL BLANC ET VERRE TREMPE**





**BOOKCASE -  
72"H / WHITE METAL WITH TEMPERED GLASS**







**POUR DE L'ASSISTANCE OU POUR COMMANDER  
DES PIÈCES CONTACTEZ NOTRE DÉPARTEMENT  
DE SERVICE À LA CLIENTÈLE.**

**FOR ASSISTANCE OR TO ORDER PARTS  
CONTACT OUR CUSTOMER SERVICE DEPARTMENT**

## LISTE DES PIÈCES PARTS LIST



PIÈCE / PART #	IMAGE	DESCRIPTION	QTY / QTÉ
<b>1</b>		<b>METAL LEG PATTE EN METAL</b>	<b>2</b>
<b>2</b>		<b>METAL LEG PATTE EN METAL</b>	<b>2</b>
<b>3</b>		<b>METAL LEG PATTE EN METAL</b>	<b>2</b>
<b>4</b>		<b>METAL LEG PATTE EN METAL</b>	<b>2</b>
<b>5</b>		<b>TOP FRAME CADRE DE SURFACE</b>	<b>1</b>

## LISTE DES PIÈCES PARTS LIST



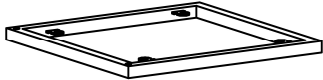

PIÈCE / PART #	IMAGE	DESCRIPTION	QTY / QTÉ
<b>6</b>		METAL FRAME CADRE EN MÉTAL	1
<b>7</b>		METAL FRAME CADRE EN MÉTAL	1
<b>8</b>		METAL FRAME CADRE EN MÉTAL	2
<b>9</b>		METAL FRAME CADRE EN MÉTAL	1
<b>10</b>		METAL FRAME CADRE EN MÉTAL	1

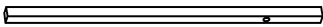
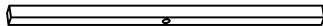
## LISTE DES PIÈCES

### PARTS LIST

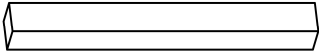
PIÈCE / PART #	IMAGE	DESCRIPTION	QTY / QTÉ
<b>11</b>		METAL FRAME CADRE EN MÉTAL	1
<b>12</b>		METAL FRAME CADRE EN MÉTAL	1
<b>13</b>		BOTTOM FRAME CADRE DU BAS	1
<b>14</b>		SUPPORT BAR BARRE DE SOUTIEN	2
<b>15</b>		SUPPORT BAR BARRE DE SOUTIEN	4

## LISTE DES PIÈCES PARTS LIST

PIÈCE / PART #	IMAGE	DESCRIPTION	QTY / QTÉ
<b>16</b>		<b>SUPPORT BAR BARRE DE SOUTIEN</b>	<b>2</b>
<b>17</b>		<b>GLASS TOP SURFACE EN VERRE</b>	<b>1</b>
<b>18</b>		<b>GLASS SHELF ÉTAGÈRE EN VERRE</b>	<b>1</b>
<b>19</b>		<b>GLASS SHELF ÉTAGÈRE EN VERRE</b>	<b>3</b>
<b>20</b>		<b>GLASS SHELF ÉTAGÈRE EN VERRE</b>	<b>3</b>

**LISTE DES PIÈCES**  
**PARTS LIST**

PIÈCE / PART #	IMAGE	DESCRIPTION	QTY / QTÉ
21		GLASS SHELF ÉTAGÈRE EN VERRE	2

## LISTE DES PIÈCES DE MONTAGE HARDWARE LIST

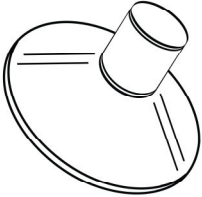
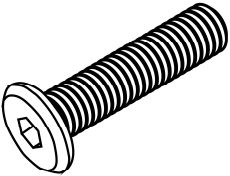
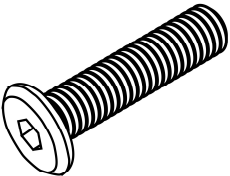
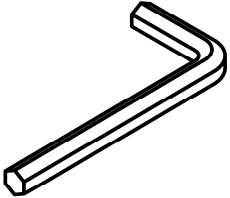
PIÈCE / PART #	IMAGE	DESCRIPTION	QTY / QTÉ
<b>A</b>		<b>SUCTION CUP - Ø 3/4"</b>  <b>VENTOUSE - Ø 3/4"</b>	<b>40</b>
<b>B</b>		<b>ASSEMBLING BOLT - Ø 1/4" X 1/2"</b>  <b>BOULON D'ASSEMBLAGE - Ø 1/4" X 1/2"</b>	<b>4</b>
<b>C</b>		<b>ASSEMBLING BOLT - Ø 1/4" X 1 3/8"</b>  <b>BOULON D'ASSEMBLAGE - Ø 1/4" X 1 3/8"</b>	<b>46</b>
<b>D</b>		<b>HEX KEY</b>  <b>CLÉ HEXAGONALE</b>	<b>1</b>

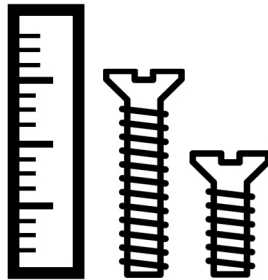

**OUTIL DE VÉRIFICATION DE DIMENSIONS DES PIÈCES  
HARDWARE DIMENSIONS VERIFICATION TOOL**



ÉTAPE / STEP 1

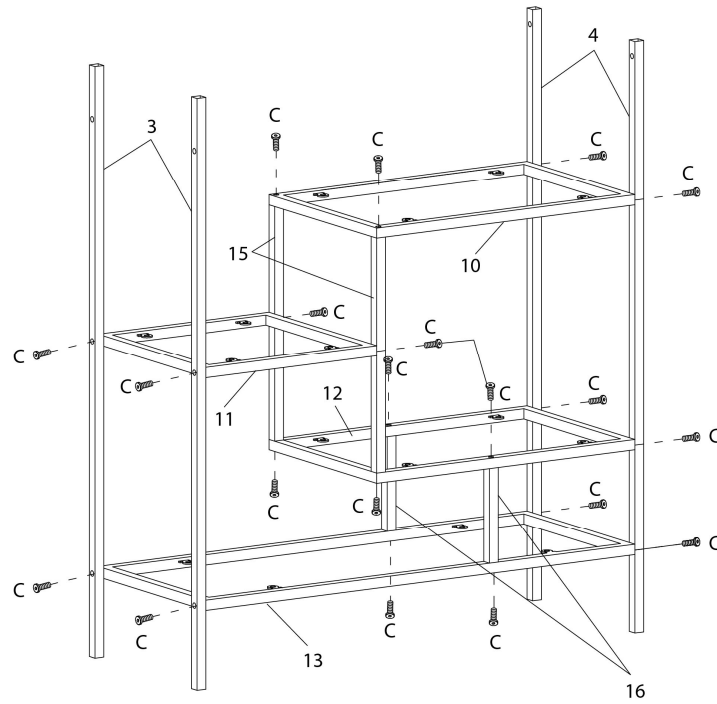

ÉTAPE / STEP 2

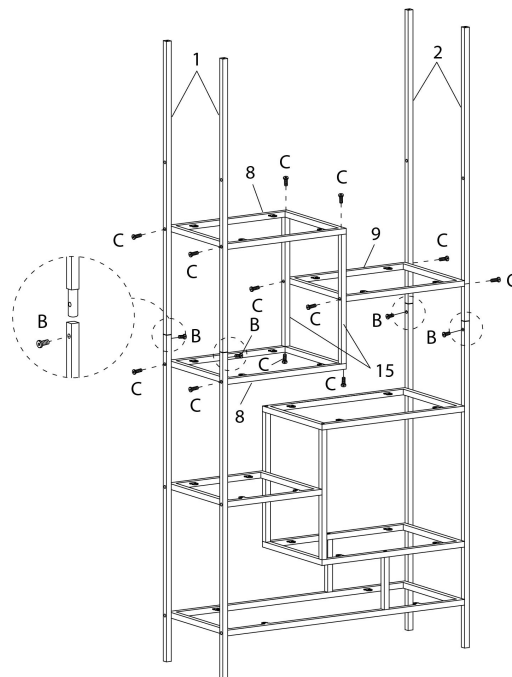

ÉTAPE / STEP 3

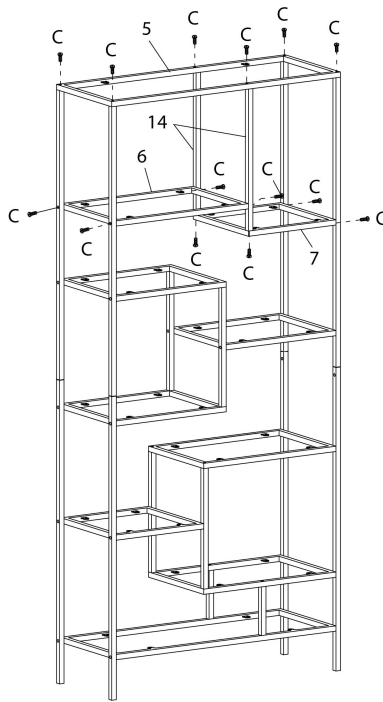

ÉTAPE / STEP 4

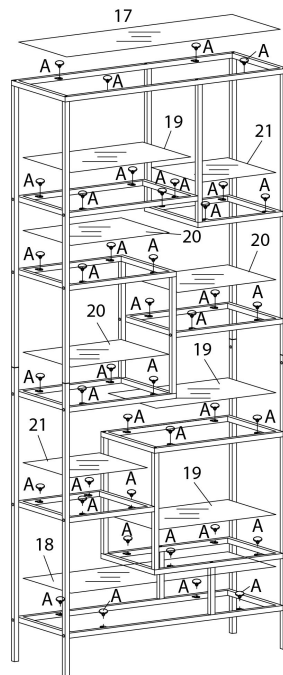

**ÉTAPE / STEP 5**

