









	A x 1		LA x 1
	B x 1		RA x 1
	C x 1		G x 12 (6.3x60)
	D x 1		H x 4 (6.3x80)
	E x 2		I x 1
	F x 1		

STEP 1:



STEP 2:

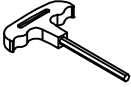
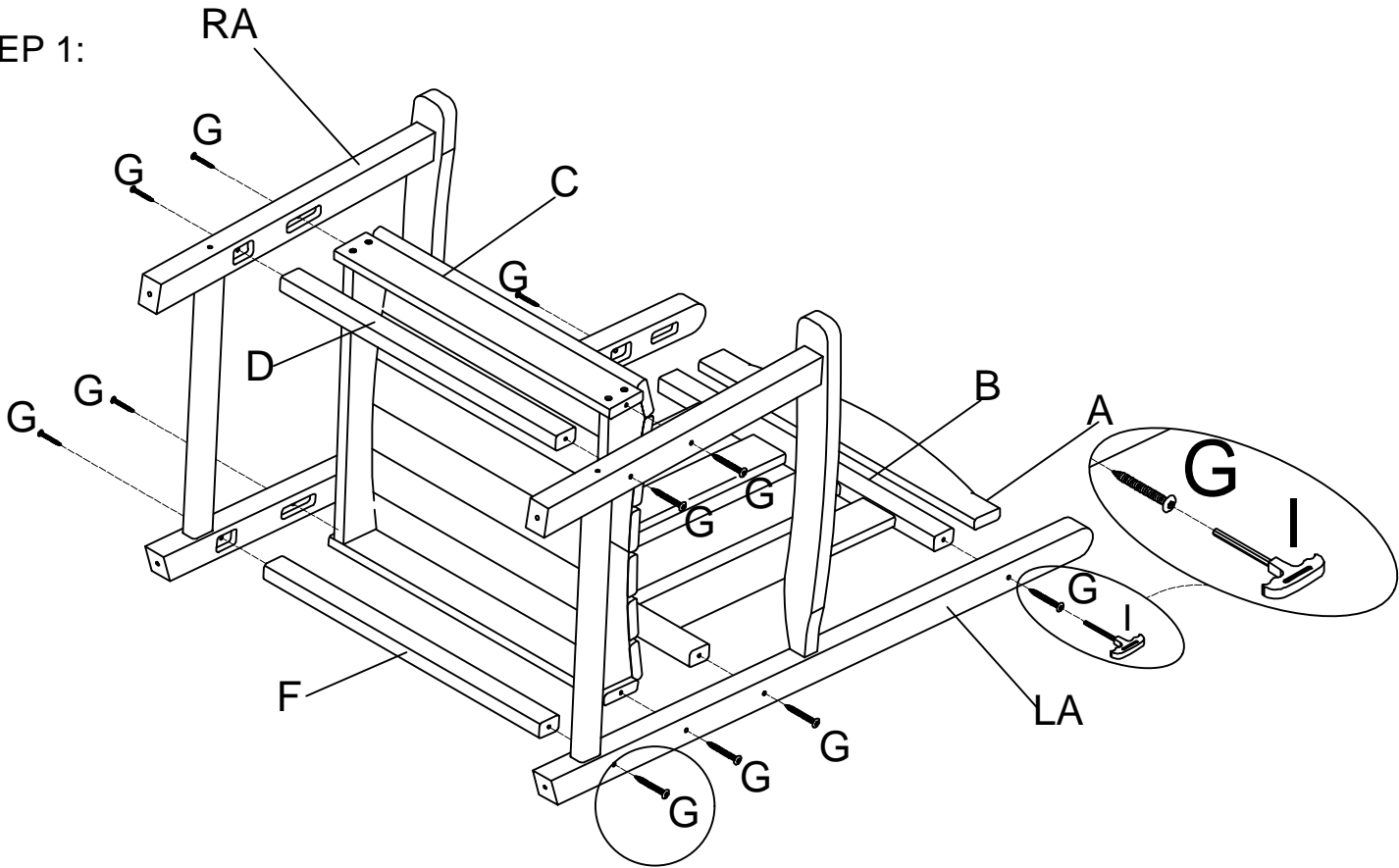