









<p>A</p>  <p>10 PCS</p>	<p>B</p>  <p>8 PCS</p>	<p>C</p>  <p>20 PCS</p>
<p>D</p>  <p>1 PC</p>	<p>E</p>  <p>2 PCS</p>	<p>F</p>  <p>20 PCS</p>
<p>G</p>  <p>8 PCS</p>	<p>H</p>  <p>2 PCS</p>	<p>I</p>  <p>2 PCS</p>

The First Step

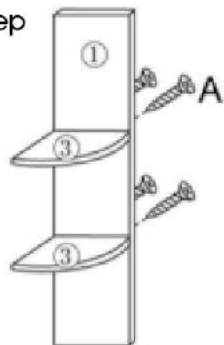

X2

The Second Step

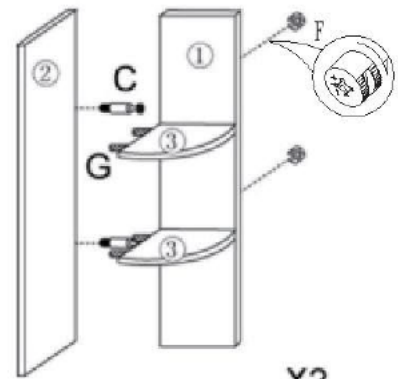

X2

The Third Step

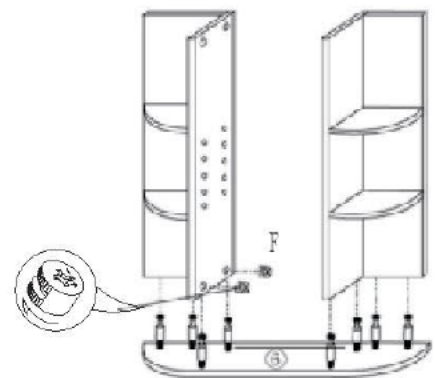

The Fourth Step

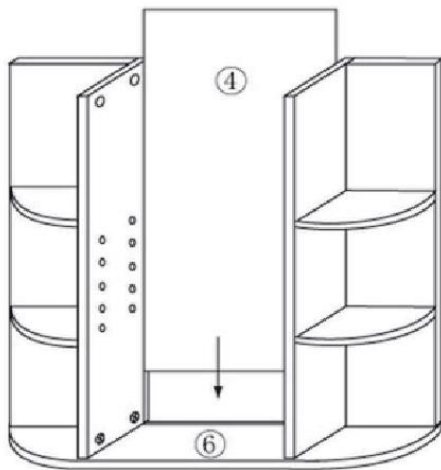

The Fifth Step

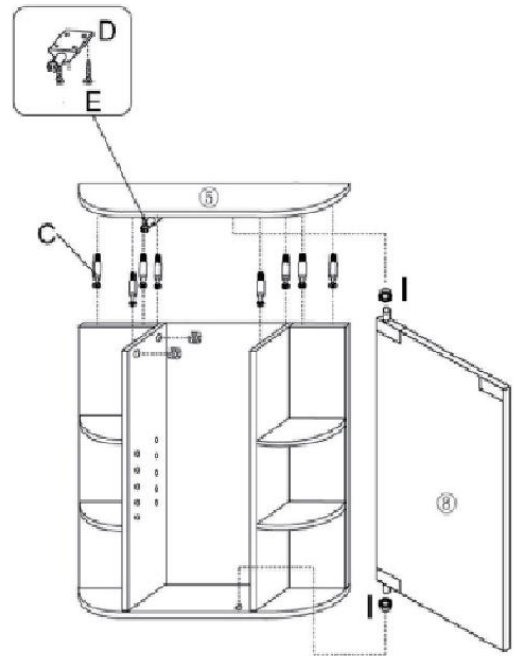

The Sixth Step

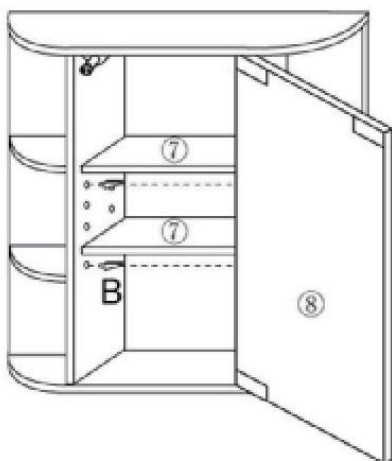

The Seventh Step

