

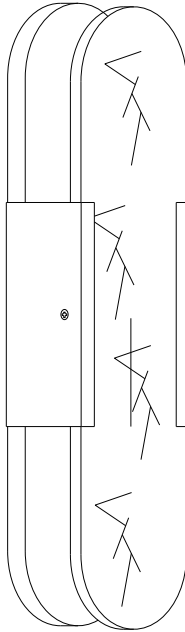







INSTALLATION MANUAL

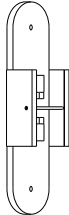

This manual only shows the installation steps for one size, and the installation methods for other sizes of products are similar.

Part list

A* 4 	B* 1 	C* 4 	D* 3 
E* 1 	F* 4 	G* 2 	H* 2 
I* 1 	J* 2	K* 0	L* 0
M* 0	N* 0	O* 0	P* 0
Q* 0	R* 0	S* 0	T* 0

STEP I Unpacking

Open the box, and take out all the accessories, you will get the following items.

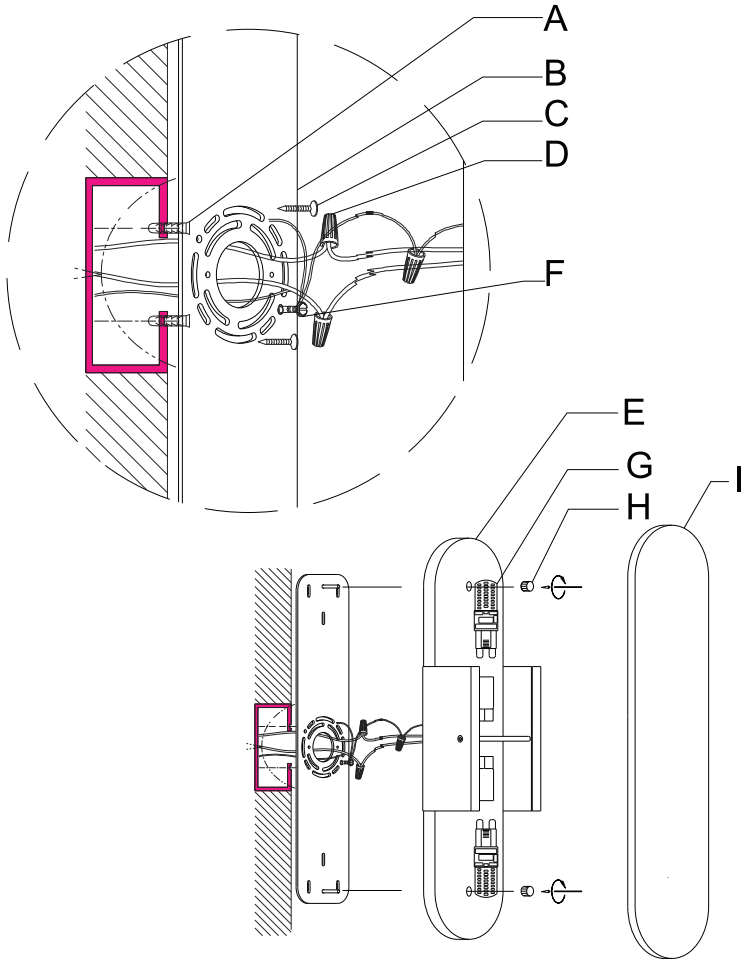

FAQ

Q: When I open the box, I find that the glass fittings are broken, what should I do?

A: As the Spanish marble lampshade fittings are natural Spanish marble, which is inherently fragile, we have taken this into account. We have made reinforced packaging inside each box, which is enough for your installation. If any of the Spanish marble fittings are broken, please contact us promptly and we will send you new Spanish marble fittings.

STEP II Branch Adjustment

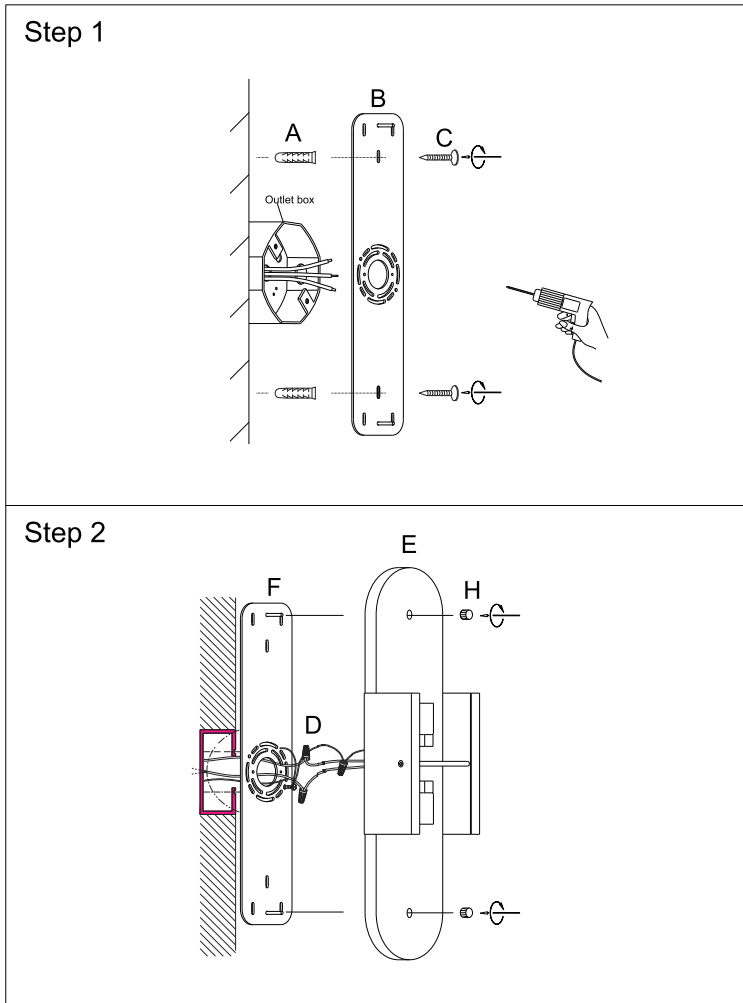

FAQ

Q: How do I differentiate between N/L wiring and a ground wire?

A: We have already distinguished between the N/L markings on the wires and the brass wire on the mounting bracket is the ground wire.

STEP III Wiring and Mounting

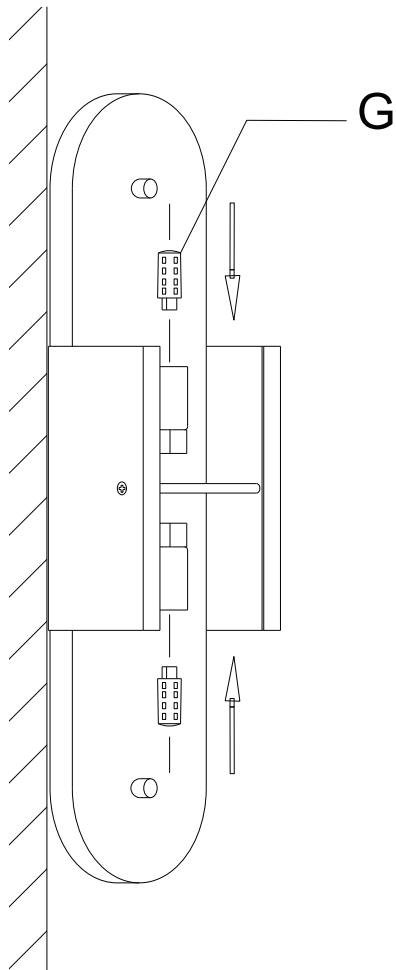

FAQ

Q: What if the bulb is not vertical when installed?

A: We can loosen the bulb to fine-tune the angle.

Ensure that the light source, when locked, is vertical! so that the locking angle touching the inner wall of the lampshade!

STEP IV Hanging Pendants

Step 4

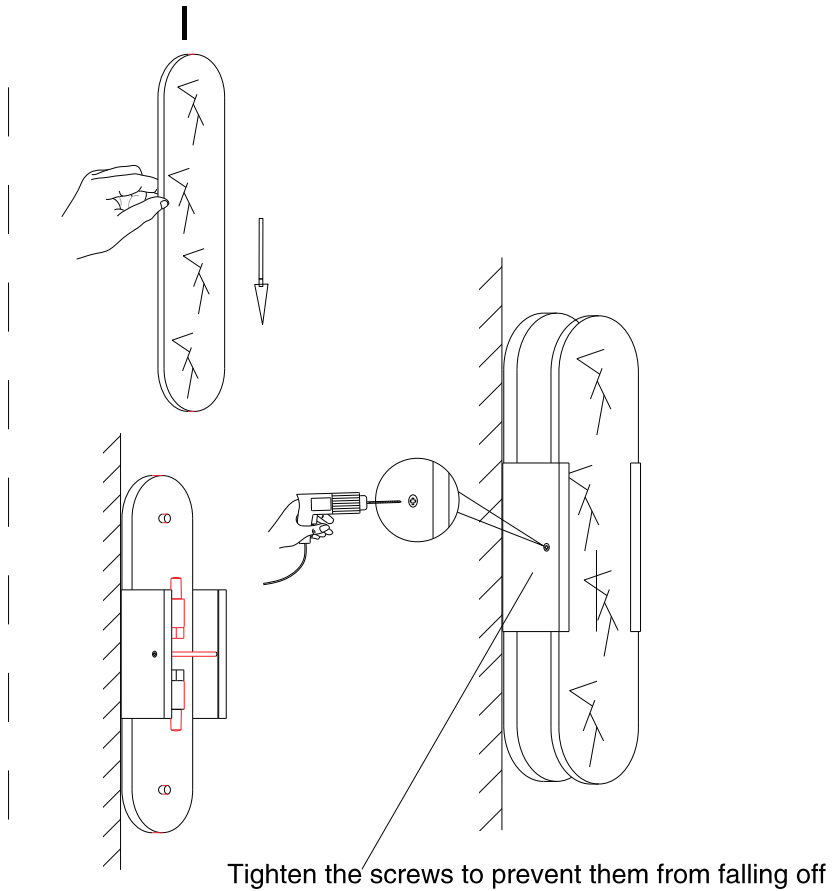

FAQ

Q: What do I need to look for when I install a Spanish lucite?

A: As Spanish marble is fragile, we simply place the Spanish marble gently on the matching lamp body, the screws need to be tightened to prevent them from falling off.

Please note:

Please check the parts list, if the parts are missing during your actual installation, please contact us, we will help you in time!

No matter what problems or questions you encounter during the installation or use of the chandelier, please feel free to contact us, we will reply you within 24 hours and quickly solve or answer for you!

When you leave message to us online, please leave your order ID and case details, The more detailed and accurate your description, the faster and more accurate

we will provide you with solutions or answers!



SAFETY INSTRUCTIONS

These instructions are provided for your safety. It is very important that they are read completely before beginning the installation of your fixture.

1. WE RECOMMEND INSTALLATION BY A LICENSED ELECTRICIAN.
2. This fixture require G9 bulbs(not included in product), bulb rated wattage Max 10W,low wattage LED bulbs are recommended. To avoid risk of fire, do not exceed the recommended wattage.
3. If any special control devices are used with this fixture, follow the instructions carefully to assure full compliance with N.E.C. requirements. If there are any questions, contact a qualified electrical contractor.
4. Please make sure shut off the main electrical supply before installation, changing bulbs or cleaning light fixture.



WARNINGS

THIS IS NOT A TOY AND THE PRODUCT HAS NO PLAY VALUE.
Keep at least 3 ft away from cribs, bassinets, and toddler beds.
Keep out of reach of children under 3.



PREPARATION

- 1.Please prepare the G9 bulb that will be given to you in advance
2. Please keep the installation site clean and tidy to avoid missing small accessories.