

# CARE AND USE GUIDE

---

**Product Dimensions: 32.0" X 32.0" X 20.0"**

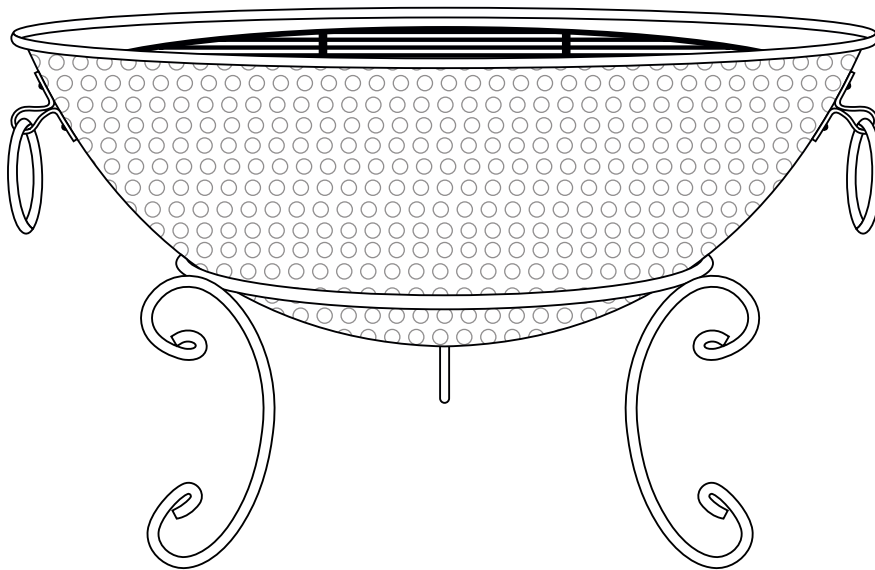

# Table of Contents

Table of Contents .....2  
 Safety Information .....2  
   Precautions .....2  
 Pre-Assembly.....3  
   Planning assembly .....3  
   Package contents .....3













Assembly ..... 4  
 Operation ..... 5  
 Care and Cleaning ..... 5

## Safety Information

### PRECAUTIONS

Use caution and common sense when using your outdoor fireplace. Failure to adhere to the safety warnings and guidelines in this manual could result in bodily injury or property damage. Save this manual for future reference.

-  **WARNING:** Fuels used in wood or charcoal burning appliances combustion of such fuels, contain chemicals known to the state of California to cause cancer and birth defects or other reproductive harm.
-  **DANGER:** To prevent personal injury, burns, property damage, or even death, carefully monitor all activity and alert all persons in the vicinity of burning outdoor fireplaces of the dangers and safety precautions associated with open flame fireplaces. Do not use outdoor fireplaces where alcoholic beverages are being consumed.
-  **DANGER:** Keep children, pets, loose clothing, and hair safely away from the outdoor fireplace. Failure to adhere to this could lead to severe personal injury or possible death. Do not allow children to use or play near this outdoor fireplace.
-  **DANGER:** Do not use indoors due to the hazard of carbon monoxide fumes and fire. Lack of ventilation may cause death.
-  **WARNING:** For outdoor use only.
-  **WARNING:** Outdoor fireplaces are only to be used in a well ventilated area a minimum of 20 ft. from building walls, overhangs, trees, and so forth to prevent fires or melting of materials from buildings.
-  **WARNING:** Do not place the outdoor fireplace where flames could ignite combustible materials such as roof overhangs, wooden structures, fuel, clothing, fabric, or dry vegetation.
-  **WARNING:** To avoid fire hazards, never leave a burning outdoor fireplace unattended. If you must leave the area of the fire pit, ensure that all fire embers are extinguished.

-  **WARNING:** Place the outdoor fireplace out of the way of pedestrian traffic, trees, and tree branches.
-  **WARNING:** Use with extreme care and at your own risk.
-  **WARNING:** The metal surface can get very hot and caution must be used when handling the fireplace after use. Never move the outdoor fireplace when in use or immediately after use when it may be hot.
-  **WARNING:** Do not touch the flame or outdoor fireplace when in use.
-  **WARNING:** Do not use during windy conditions.
-  **WARNING:** Please check with your local fire municipality or authority on any restrictions of use.
-  **WARNING:** Do not overload the bowl beyond 6 to 8 pounds.
-  **WARNING:** Place the outdoor fireplace on firm, level ground or surfaces free of debris. Do not use on wooden or composite decks.
-  **WARNING:** It is advised that a fire extinguisher be readily available. Refer to your local authority to determine the proper size of the fire extinguisher.
-  **WARNING:** Do not use the outdoor fireplace for other than its intended purpose.
-  **WARNING:** Do not attempt to service or modify the fireplace other than normal maintenance procedures as explained in the Care and Cleaning section of this manual.
-  **WARNING:** Metal surfaces will become extremely hot during use. Always use caution when handling a spark screen and a screen lifting tool, if equipped. Failure to wear flame retardant, protective gloves while handling steel parts may lead to serious burns and injury.
-  **WARNING:** Never use gasoline, kerosene, alcohol, or other flammable fuel in or around the outdoor fireplace. Do not use the outdoor fireplace near gasoline or other flammable liquids, gases, or where flammable vapors may be present.

# Pre-Assembly

## PLANNING ASSEMBLY

Read all safety warnings and instructions carefully and thoroughly before assembling and operating your outdoor fireplace. Familiarize yourself with the inventory of parts and the accompanying illustrations to ensure safe and proper assembly. The manufacturer is not responsible for any injury that may occur during the assembly of this product.

Place the parts on a soft surface to assemble and prevent scratching the finish.

## PACKAGE CONTENTS

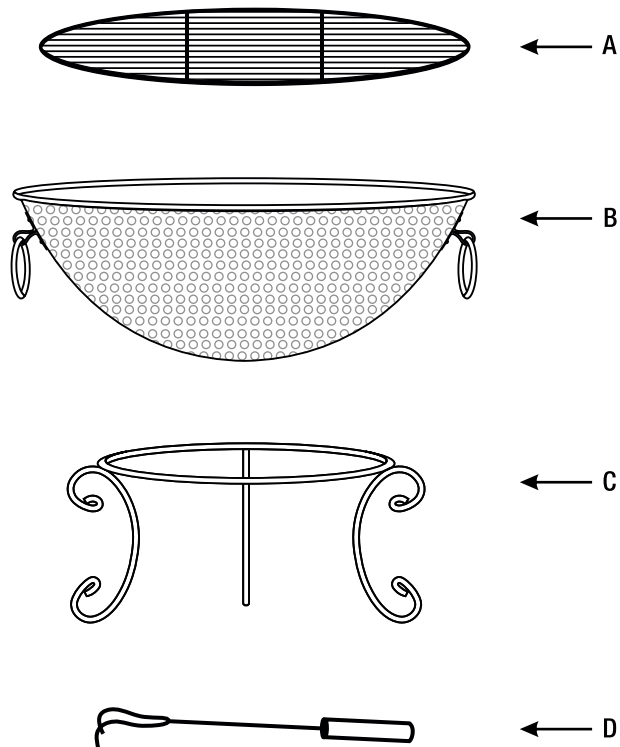

Part	Description	Quantity
A	Grate	1
B	Pan	1
C	Stand	1
D	Poker	1

## Assembly

### 1 Assembling the pan

- Place the stand (C) upright position on a soft, flat surface and place the pan (B) into the stand (C).

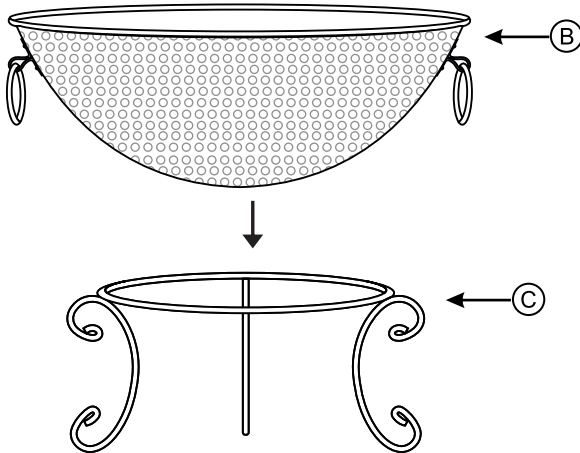

### 2 Assembling the pan

- Place the log grate (A) into the pan (B).

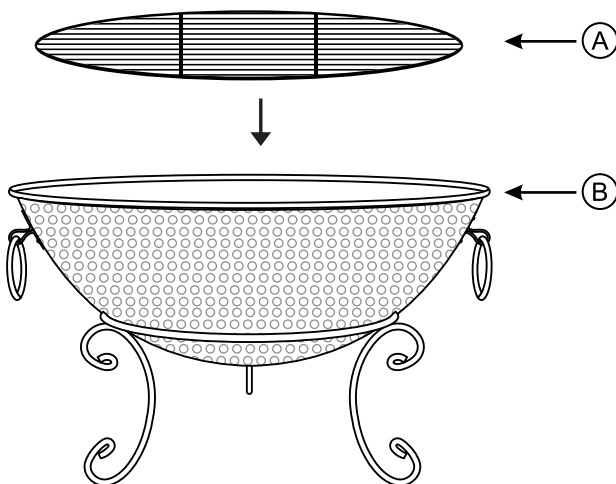

## Operation

### 1 Starting a fire



**WARNING:** Do not use charcoal or an artificial log.



**WARNING:** Do not use large logs. Do not overload the fire bowl beyond 6 to 8 pounds.



**WARNING:** Do not use gasoline or kerosene to start a fire.



**CAUTION:** Keep the fire at a reasonable level, as large fires can damage or shorten the life of the unit.

- Place three to four sheets of crumpled newspaper on top of the fire log grate (A).
- Pile finely-split, dry firewood on top of the loosely crumpled newspaper.
- Carefully light the loosely crumpled newspaper underneath the firewood.

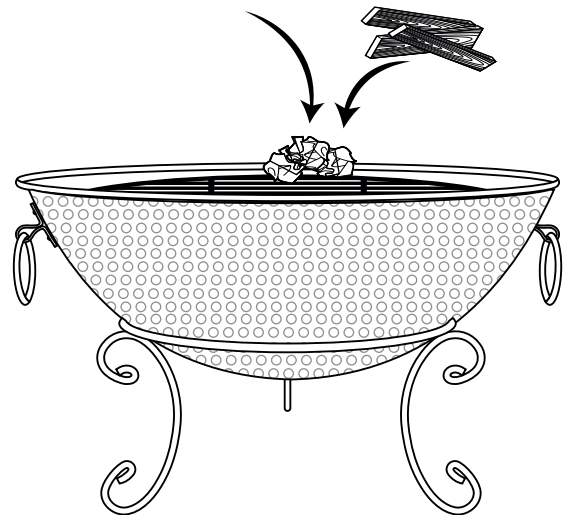

## Care and Cleaning

---

- Once the fireplace is completely cooled down, remove the mesh cover using the handle. Pour the ashes from the pan and rinse with clean water and allow to dry completely.
- Clean after each use.
- Do not use a scrub brush.
- If the paint chips, use only high-temperature paints and a brush to fix.
- If rust is showing, sand lightly and repaint the area with high-temperature paints.
- Dry with a soft cloth.
- Turn the unit upside down when not in use to prevent water from collecting.
- Cover the unit when not in use to prolong the life.
- Keep your firepit out of rain.