

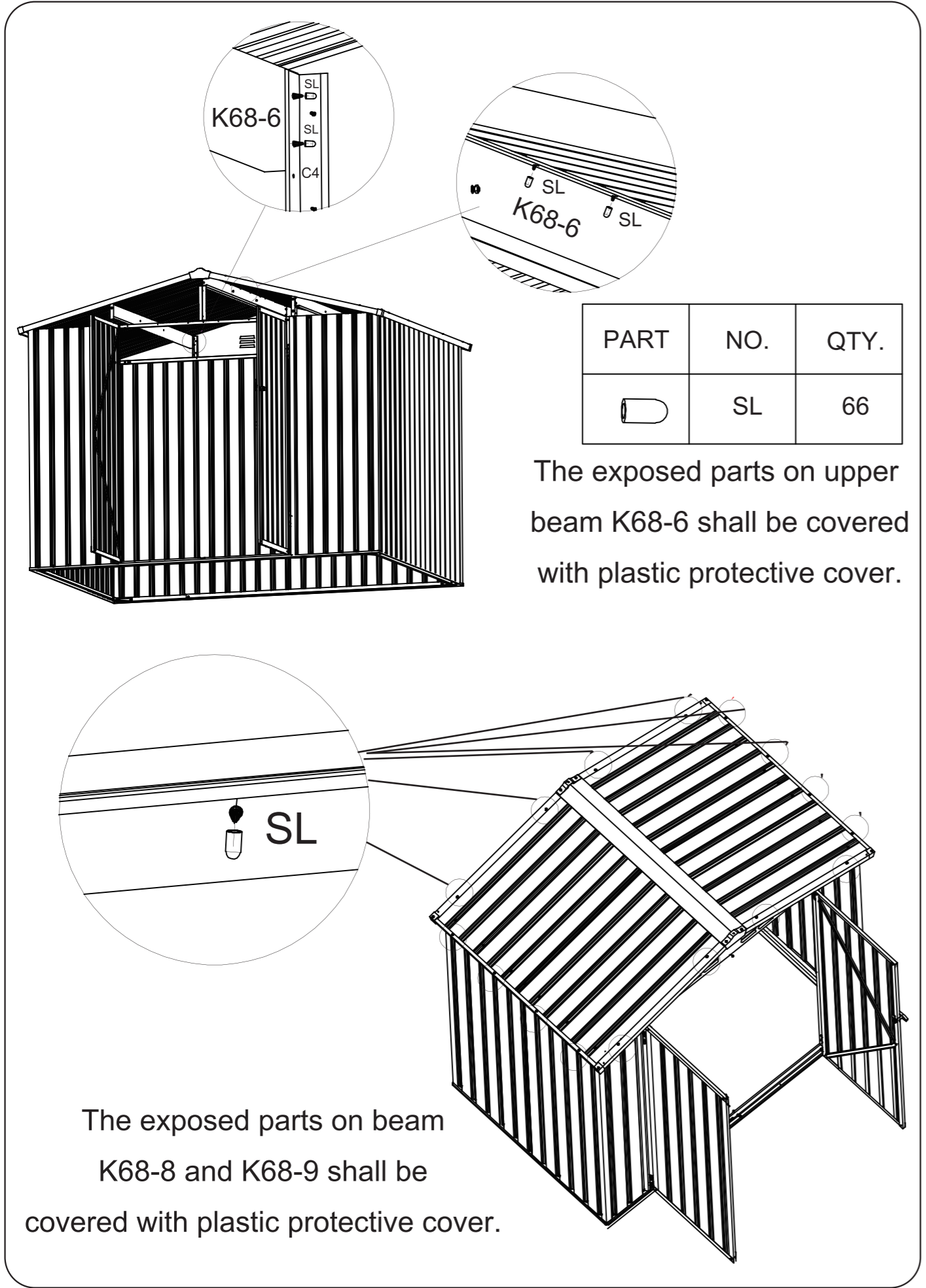

6*8 Storage Shed Installation_SS16208GR_12



PART	NO.	QTY.
	SL	66

The exposed parts on upper beam K68-6 shall be covered with plastic protective cover.

The exposed parts on beam K68-8 and K68-9 shall be covered with plastic protective cover.

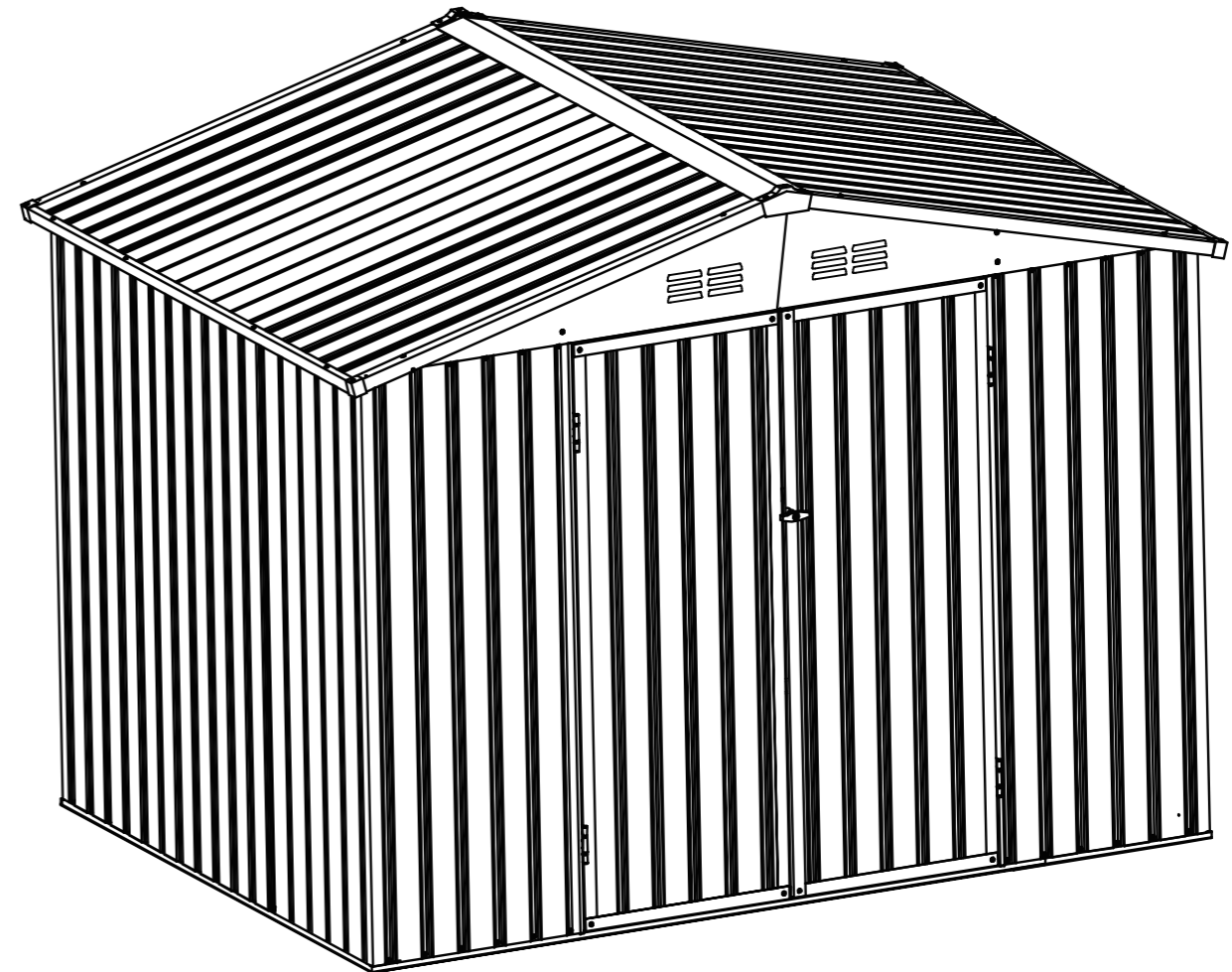

 The product comes in two packages. Please install after receiving all packages.

Please prepare below tools before installation.(Not Included)

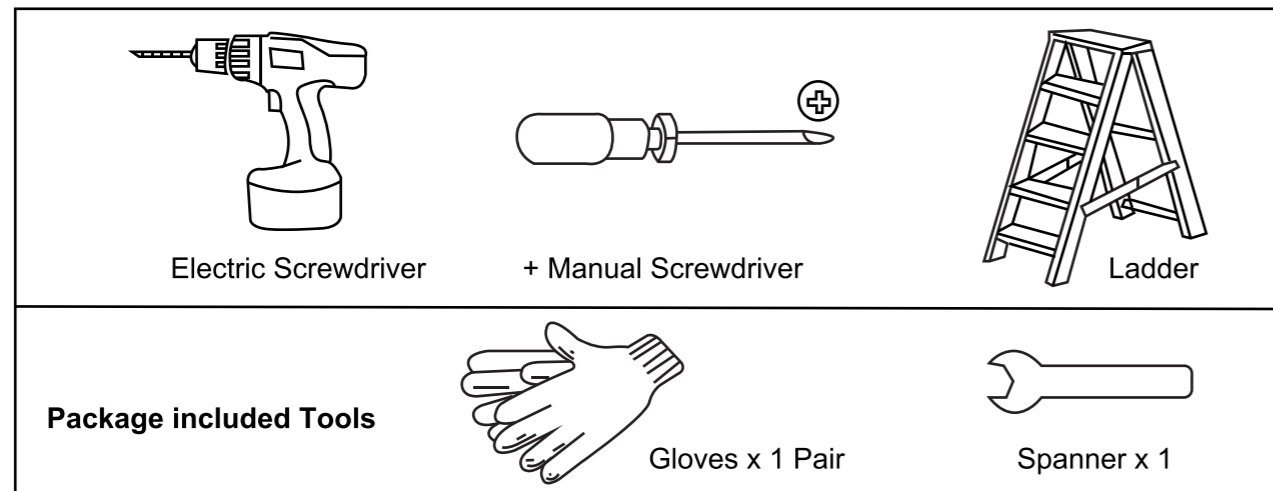

ATTENTION:

Please read this instruction carefully before installation and follow it strictly during installation. Ensure that there are no problems later due to installation errors.

Installation Notes

Please check the quantity of all parts before installation (Please refer to the Parts Lists) and the appearance of the products. Please make sure the product is correct before installation. If there is any problem, please contact us directly.

Make sure the colored panels are facing outwards and all the holes match. The panels are textured, please install the panels in the order specified in the instructions. All lines and holes must be accurately matched to make the storage shed more stable. Please ensure that all screws are tightened to prevent the product from falling apart.

There is a protective film on the surface to protect the product, please tear it off after installation to get the final presentation. If you do not damage the film during installation, it can also remain on the product to protect the product.

Please place the product on a flat ground to prevent leaning and collapse. If the ground is uneven, the door may can't be closed.





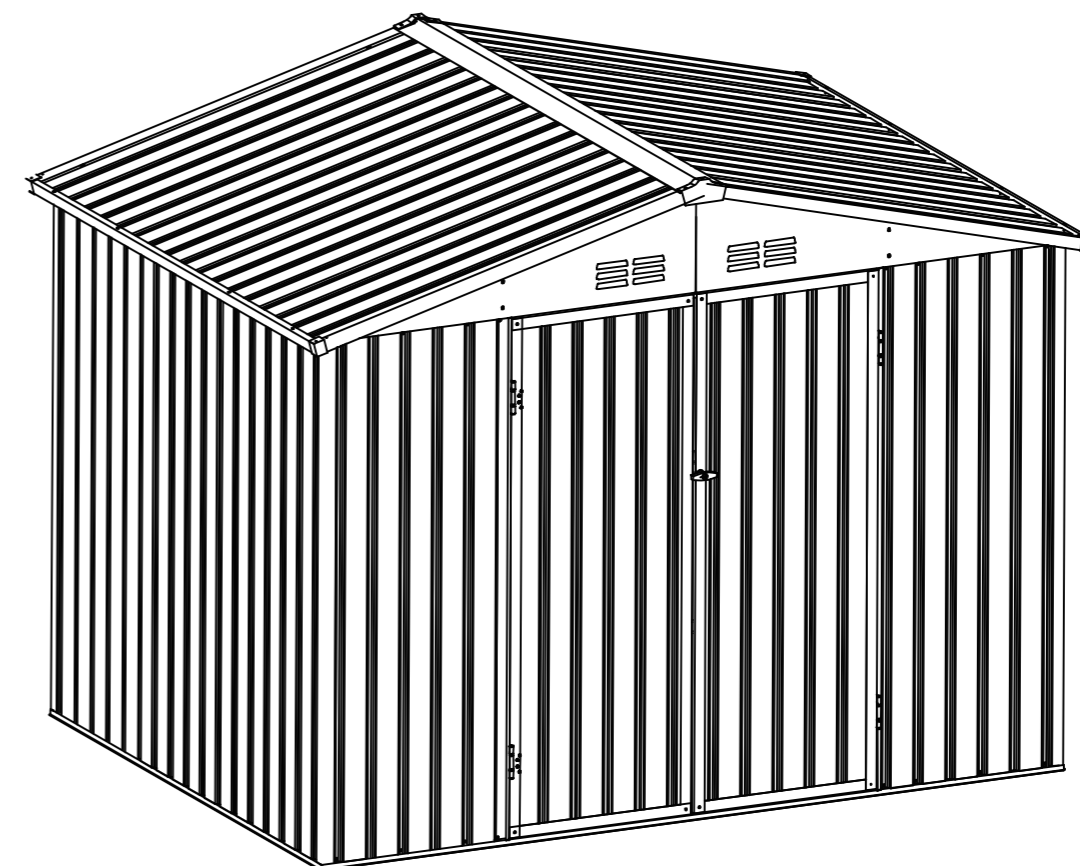
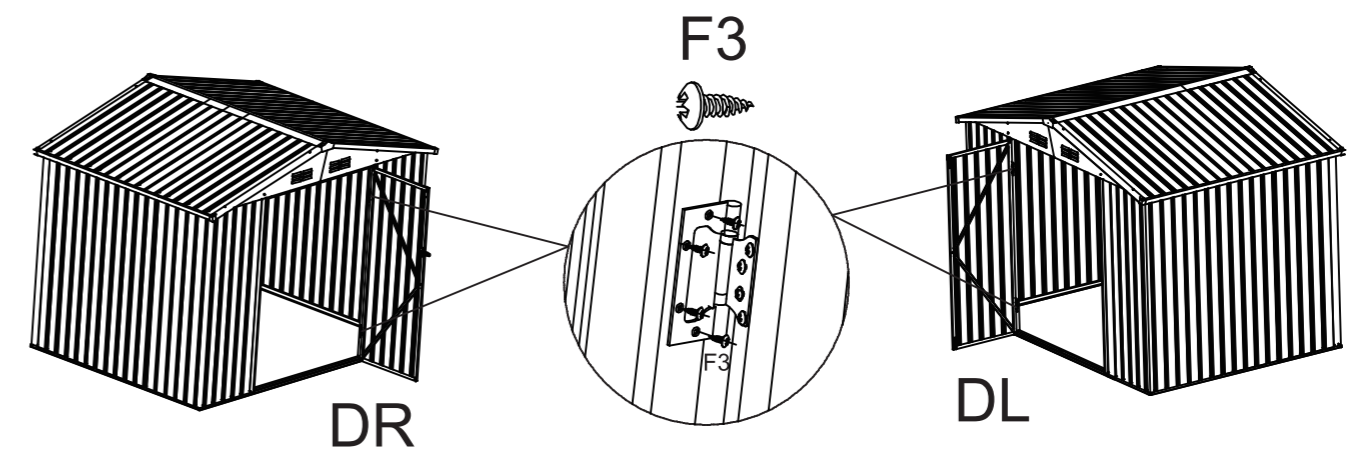

! Safety Precautions

We recommend two adults to complete the installation. Two adults installed together will make the installation process easier and safer. The gloves must be carried to prevent hand cuts during installation. Take care when using power tools near water the use of a residual current device(RCD) is advised. Please use the electric driver carefully during screwing to prevent the screw from slipping and hurting your hand.(We recommend that beginners use a manual screwdriver for installation.) Be careful not to fall when installing the roof. Please steady the ladder and make sure the product placed on a flat ground.

PLEASE KEEP THIS INSTRUCTION FOR FUTURE REFERENCE.







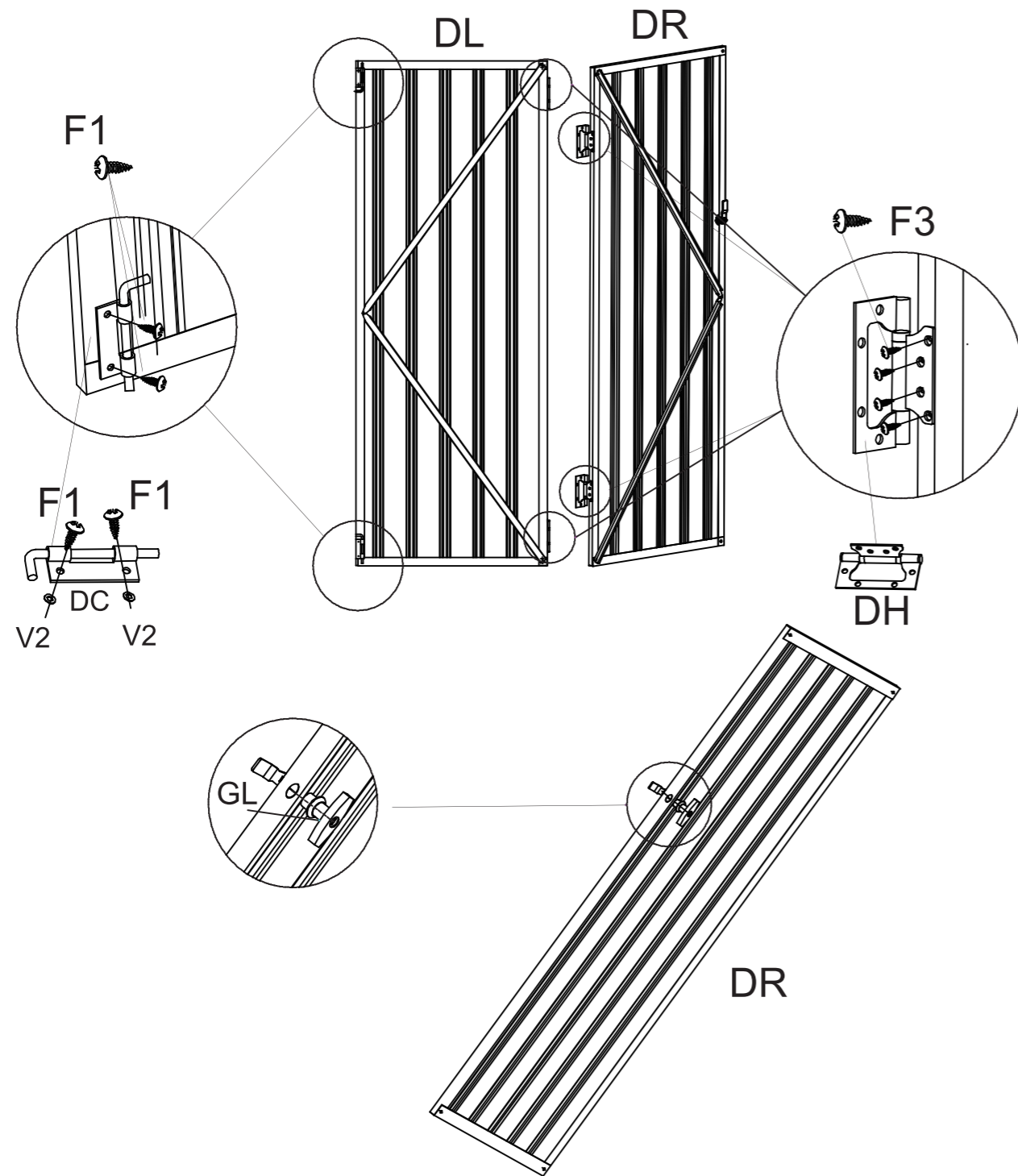









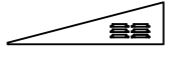



PART	NO.	QTY.
	DL	1
	DR	1
	F3	16



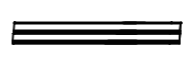
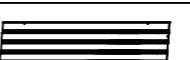

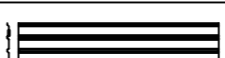



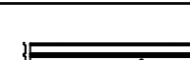





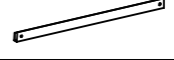

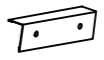



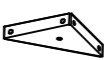

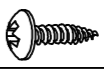

PART	NO.	QTY.
	DH	4
	DC	2
	F3	16
	GL	1
	F1	4
	V2	4

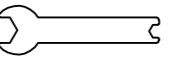

Part List

PART	NO.	QTY.
	K68-1	2
	K68-1R	2
	K68-2	2
	K68-3	2
	K68-4	2
	K64-4L	2
	K68-5L	2
	K68-5R	2
	K68-6	4
	K68-8	4
	K68-9	2
	K68-10	1
	K68-7L	2
	K68-7M	4
	K68-7MM	2
	K68-7R	2
	W5-C	4
	W5	12
	W3	2
	W5-K	2
	W2-HL	1
	W2-HR	1

PART	NO.	QTY.
	UA	2
	DA	2
	DLA	1
	DRA	1
	DDA	4
	DBA	4
	C3	4
	C4	4
	GC	4
	GE	2
	T-F	4
	F1	334
	F2	37
	F3	32
	V2	320
	F4	4
	DC	2
	C2	4
	DH	4
	GL	1
	SL	66
	M20	1
	ST	1

Part List

Shed top panels

NO.	QTY.
K68-8	4
K68-9	2
K68-10	1
K68-7L	2
K68-7M	4
K68-7MM	2
K68-7R	2
GC	4
GE	2

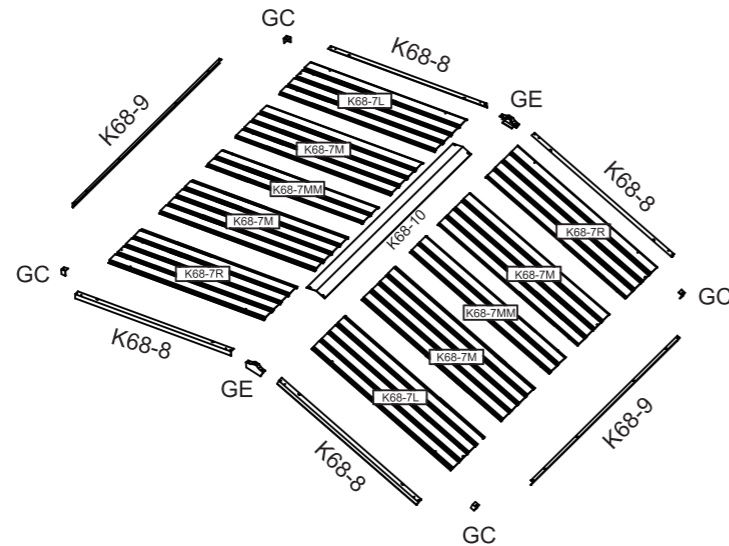

Shed top frame

NO.	QTY.
K68-3	2
k68-6	4
k68-4	2
k68-4L	2
K68-5L	2
k68-5R	2
C2	4
C3	4
C4	4

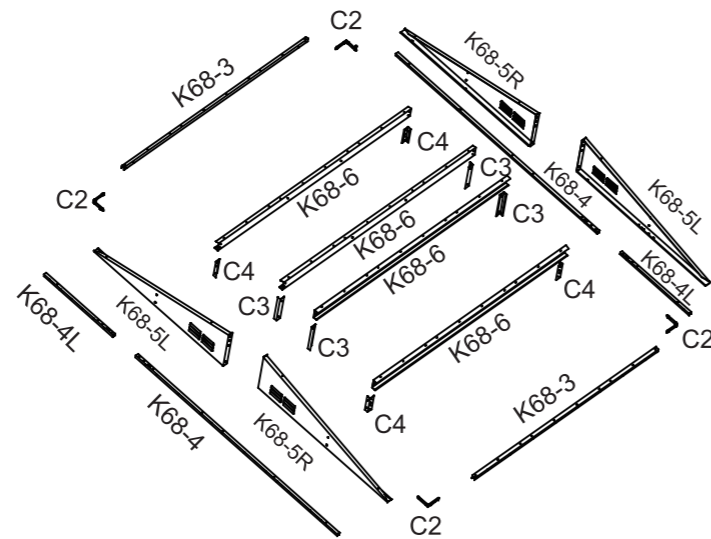

Door		Shed base	
NO.	QTY.	NO.	QTY.
UA	2	T-F	4
DA	2	K68-1	2
DH	4	K68-1R	2
DDA	4	K68-2	2
W5-K	2		
DBA	4	Shed side	
W2-HL	1	NO.	QTY.
DLA	1	W5	12
DRA	1	W3	2
W2-HR	1	W5-C	4
DC	2		
GL	1		

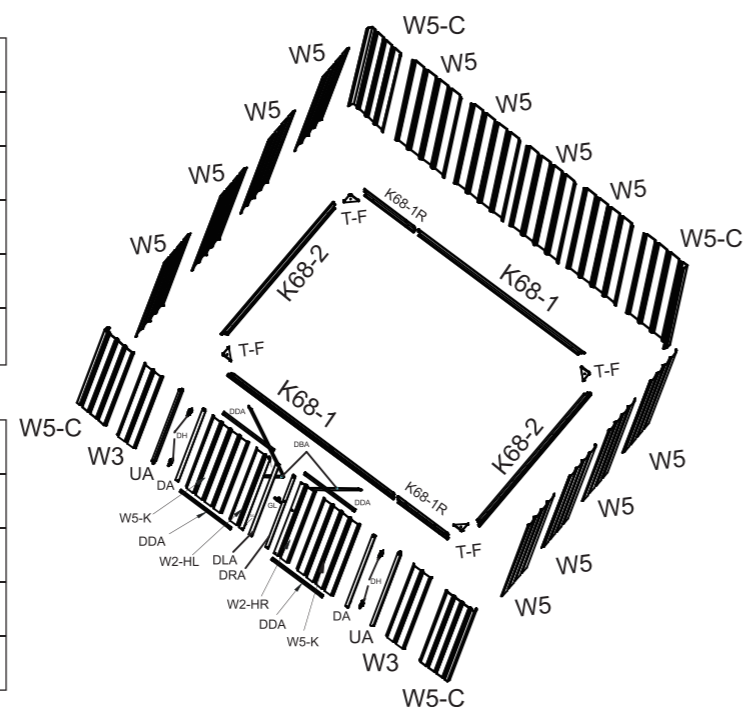

DR

PART	NO.	QTY.
	W5-K	1
	W2-HR	1
	F2	2

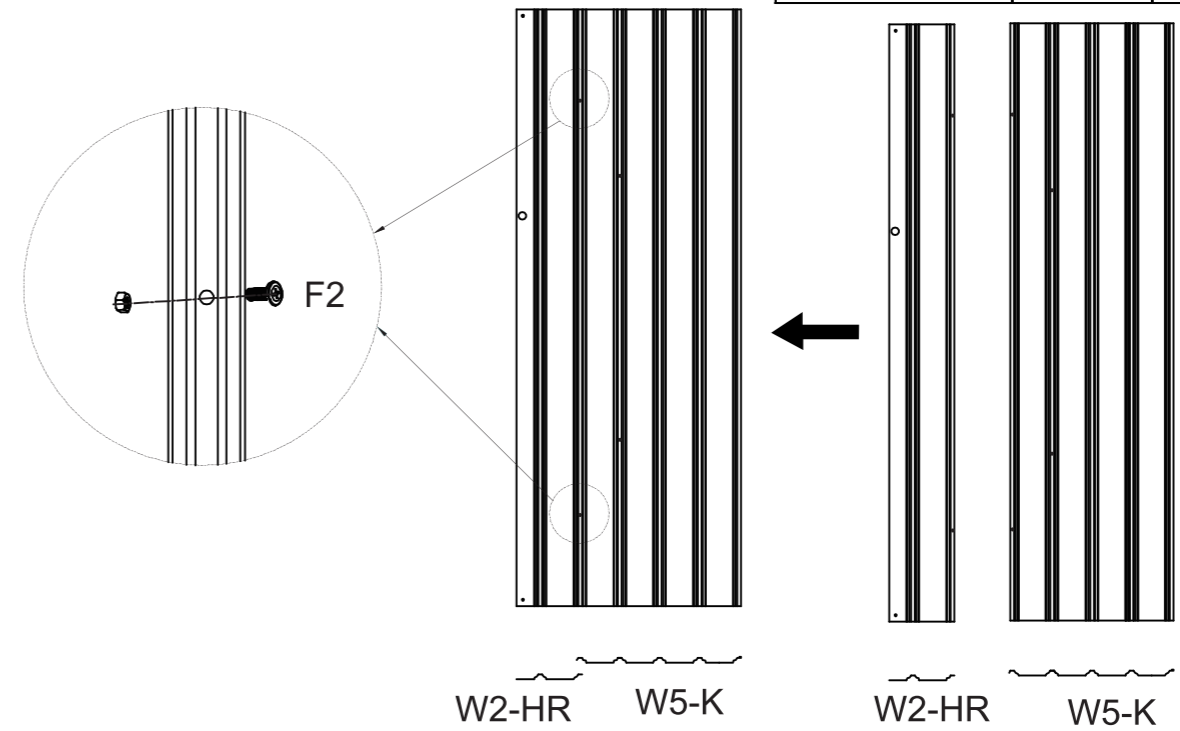



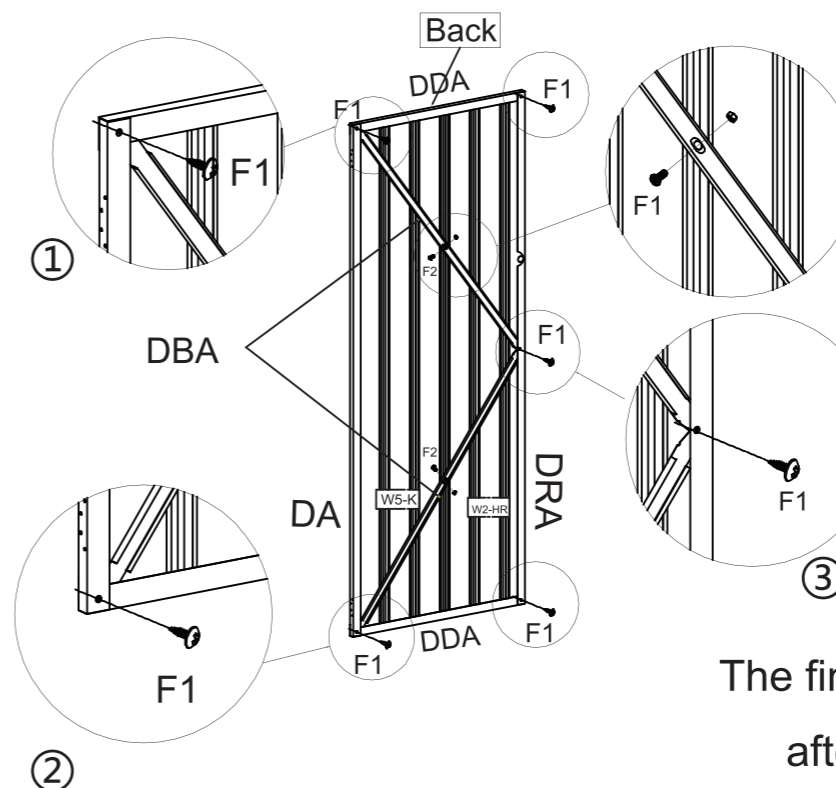

Please follow the steps ①-②-③ install.



PART	NO.	QTY.
	DA	1
	DRA	1
	DDA	2
	DBA	2
	F1	9
	F2	2

The final fixation should be done after all parts are aligned.

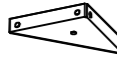



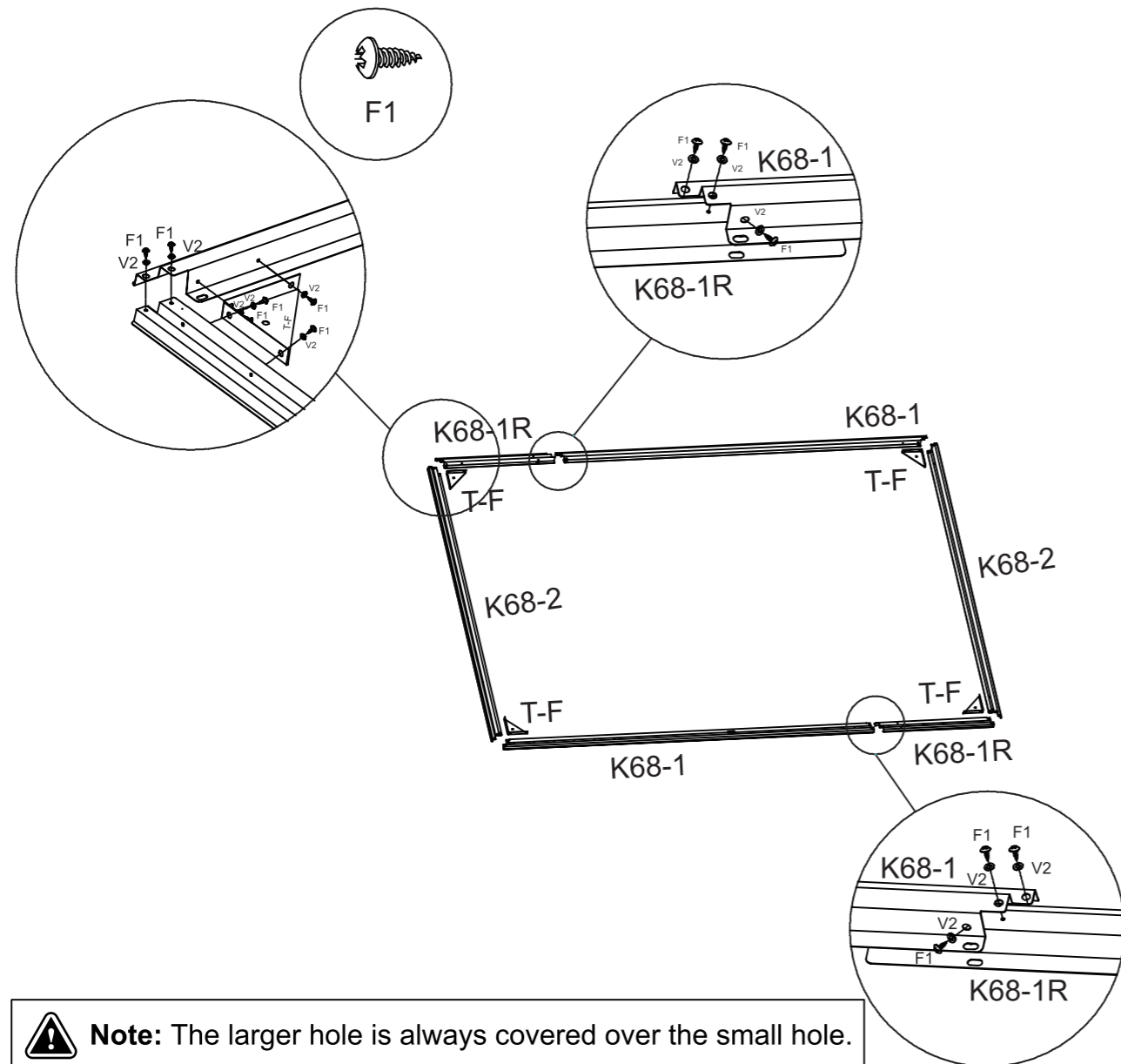

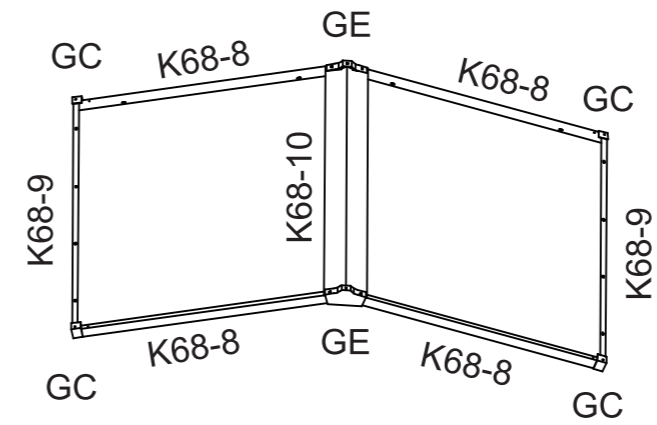

Shed Base Frame Assemble

PART	NO.	QTY.
	K68-1	2
	K68-1R	2
	K68-2	2
	T-F	4
	V2	30
	F1	30







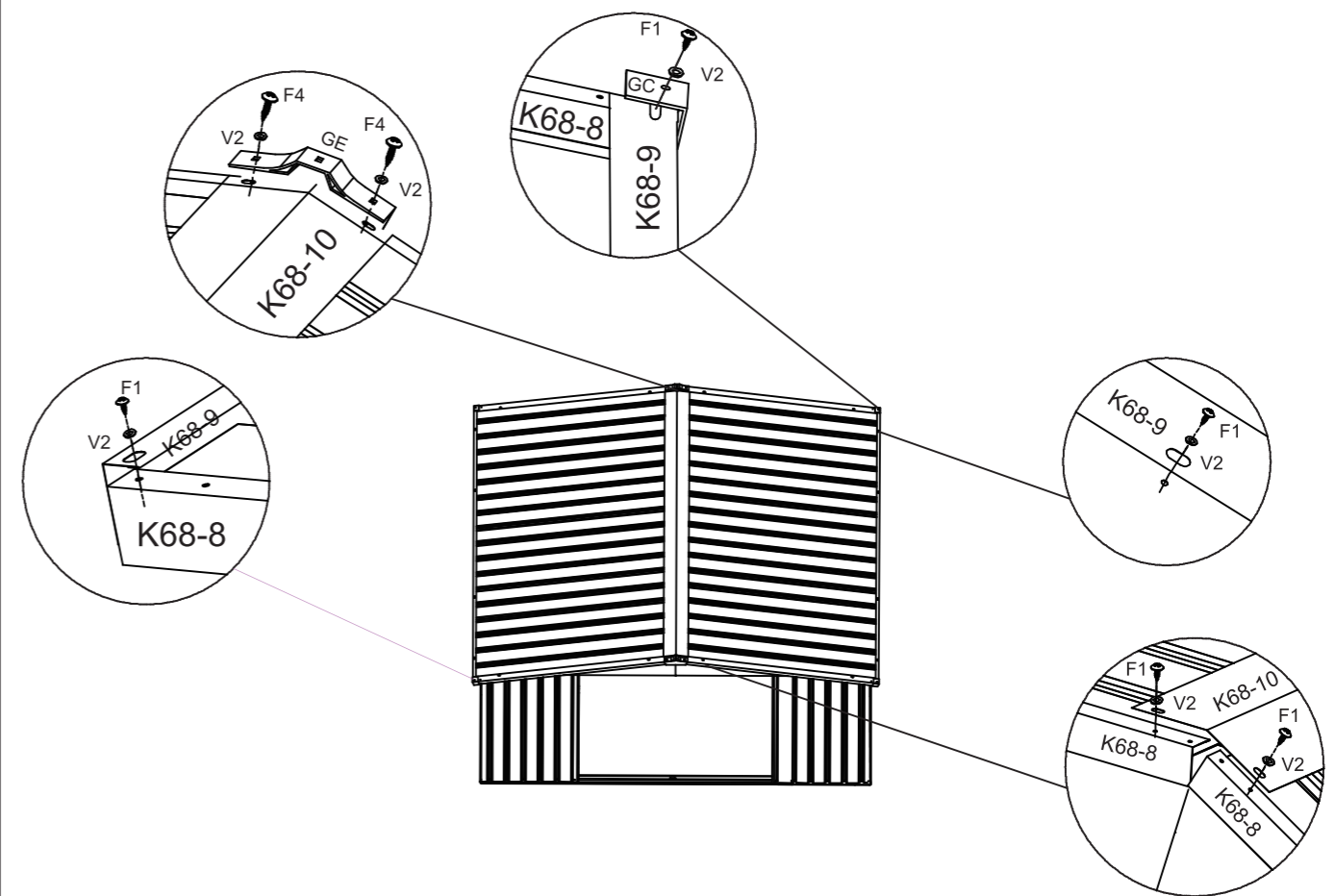

Note: The larger hole is always covered over the small hole.



PART	NO.	QTY.
	K68-8	4
	K68-9	2
	K68-10	1
	GC	4
	GE	2
	F1	20
	V2	24
	F4	4





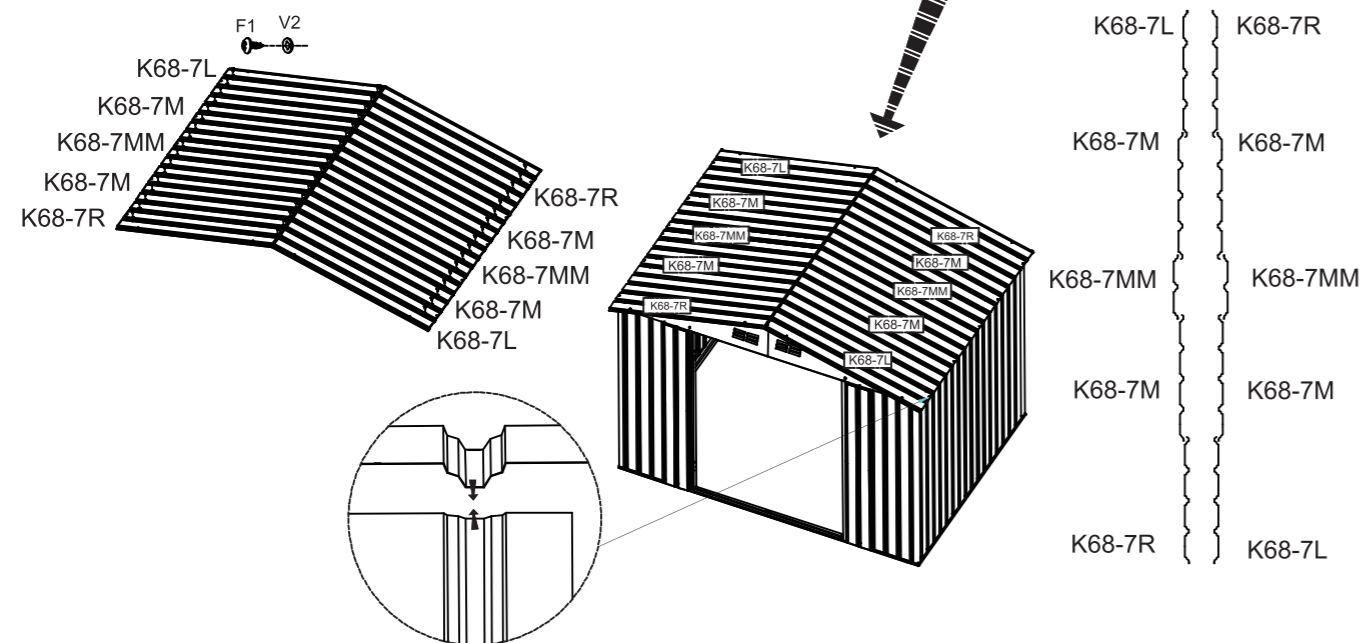
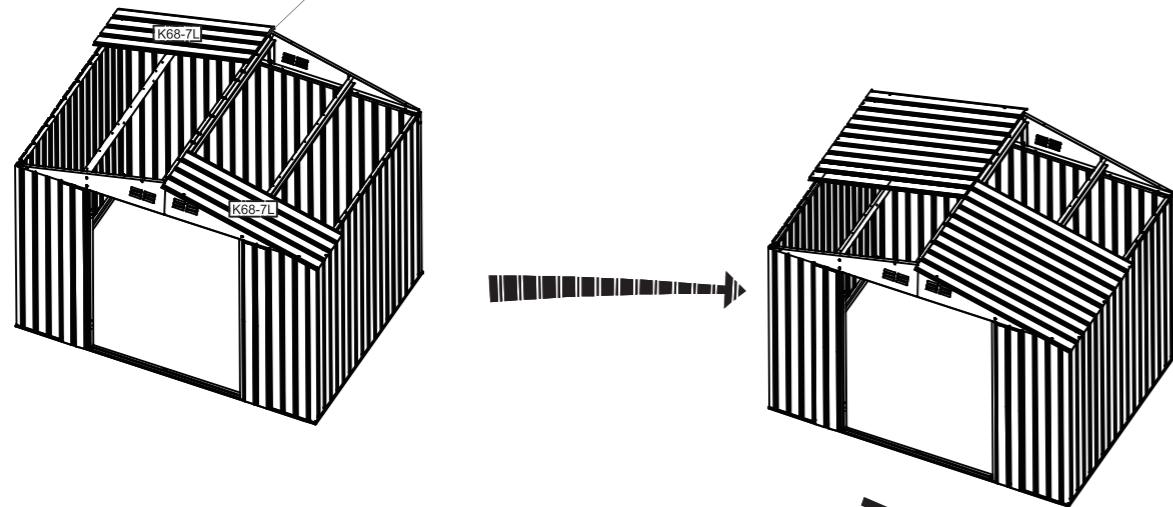
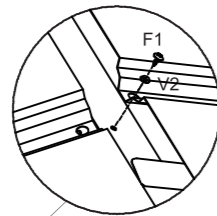

Shed Top Panels Assemble

PART	NO.	QTY.
	K68-7L	2
	K68-7M	4
	K68-7MM	2
	K68-7R	2
	F1	68
	V2	68

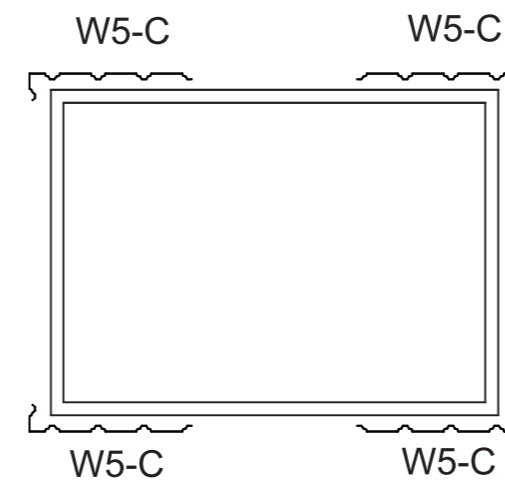

Shed Side Panels Assemble





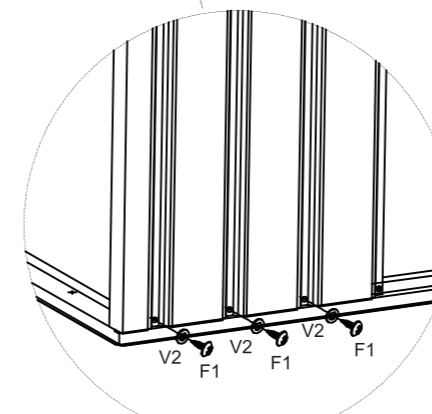
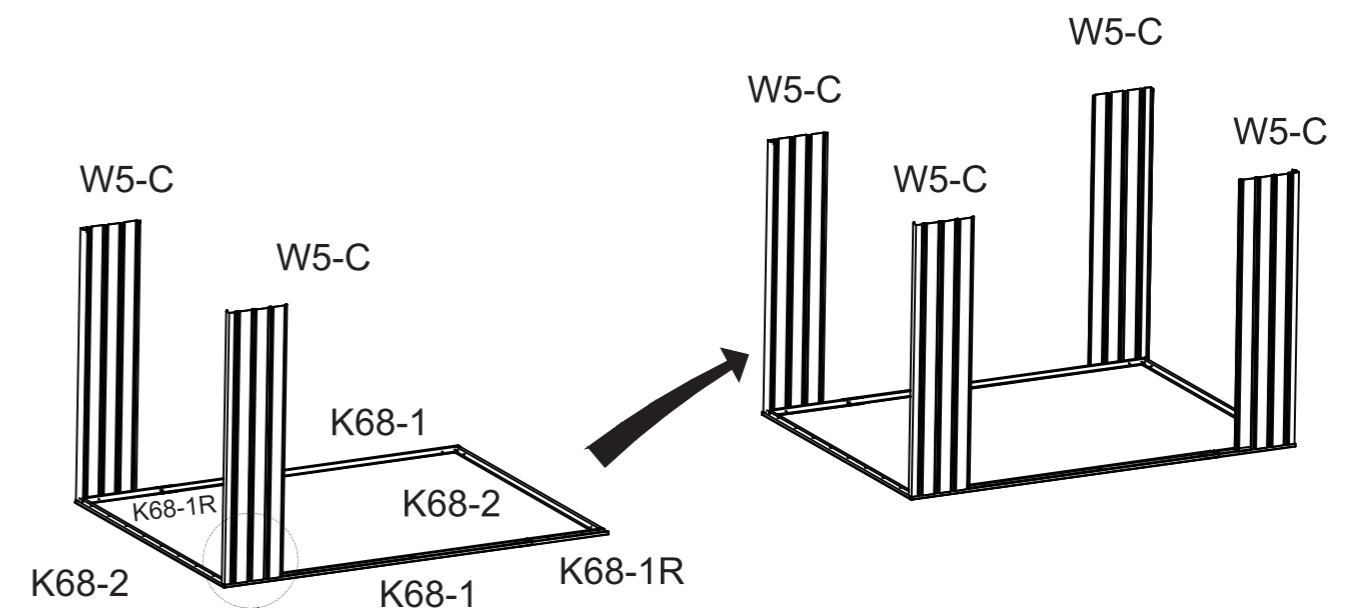

PART	NO.	QTY.
	W5-C	4
	V2	12
	F1	12



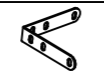

Please do not install the screw here.
They will be installed after the other plates are installed.

Note: Two Adults Are Required

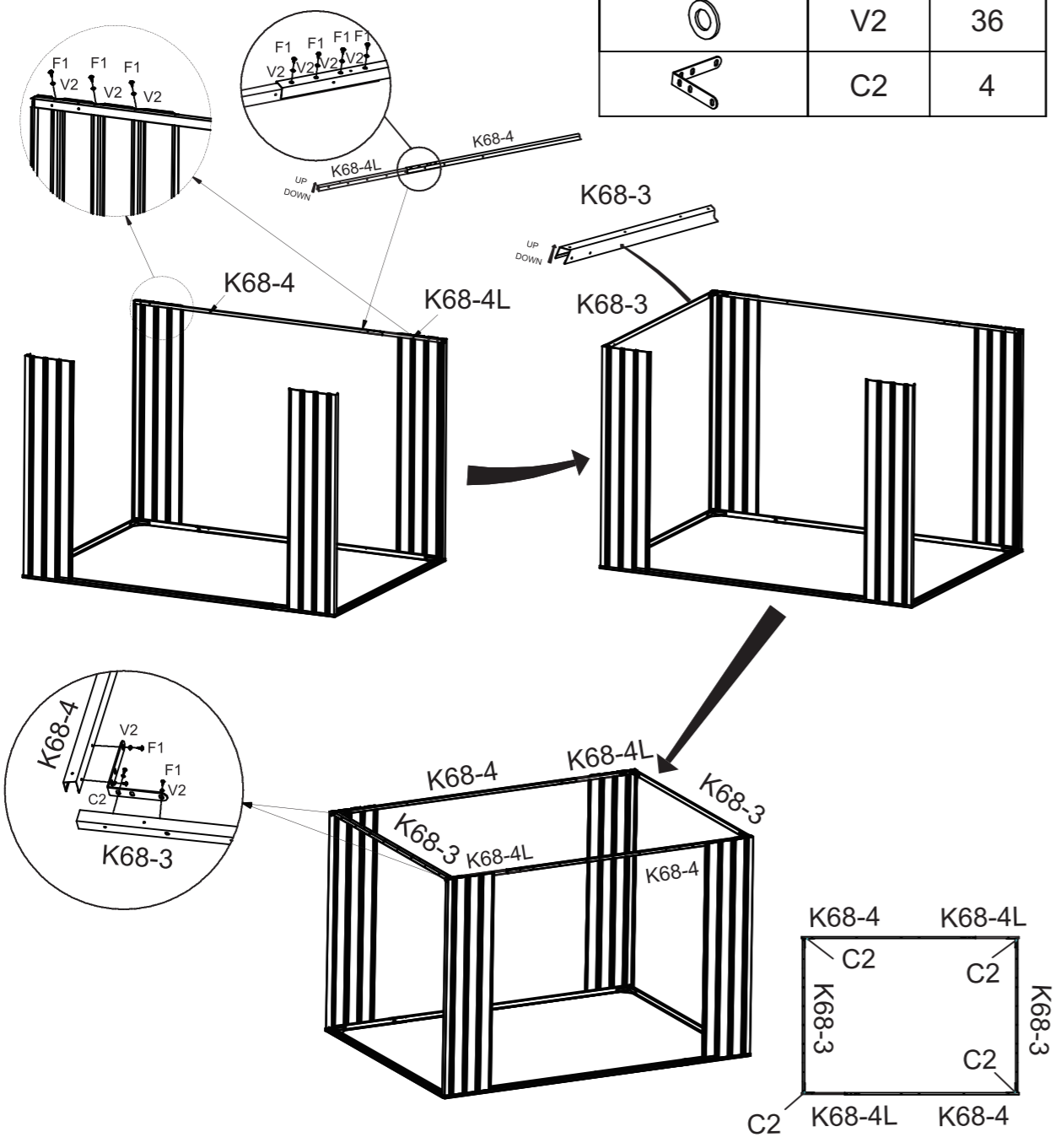



PART	NO.	QTY.
	K68-3	2
	K68-4	2
	K68-4L	2
	F1	36
	V2	36
	C2	4



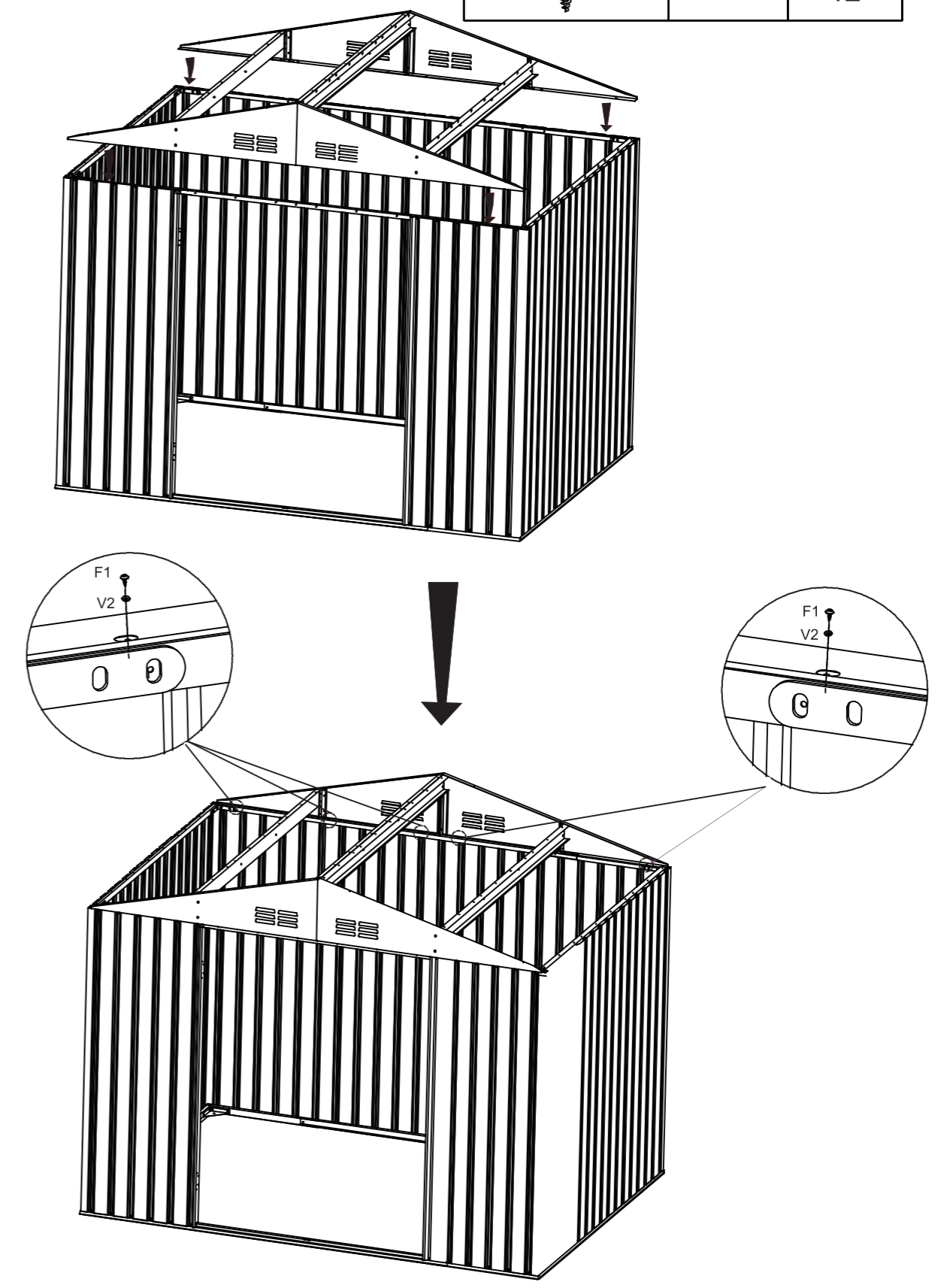



Note: Two Adults Are Required

PART	NO.	QTY.
	V2	12
	F1	12

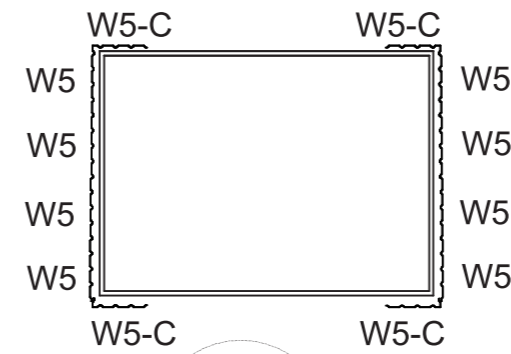
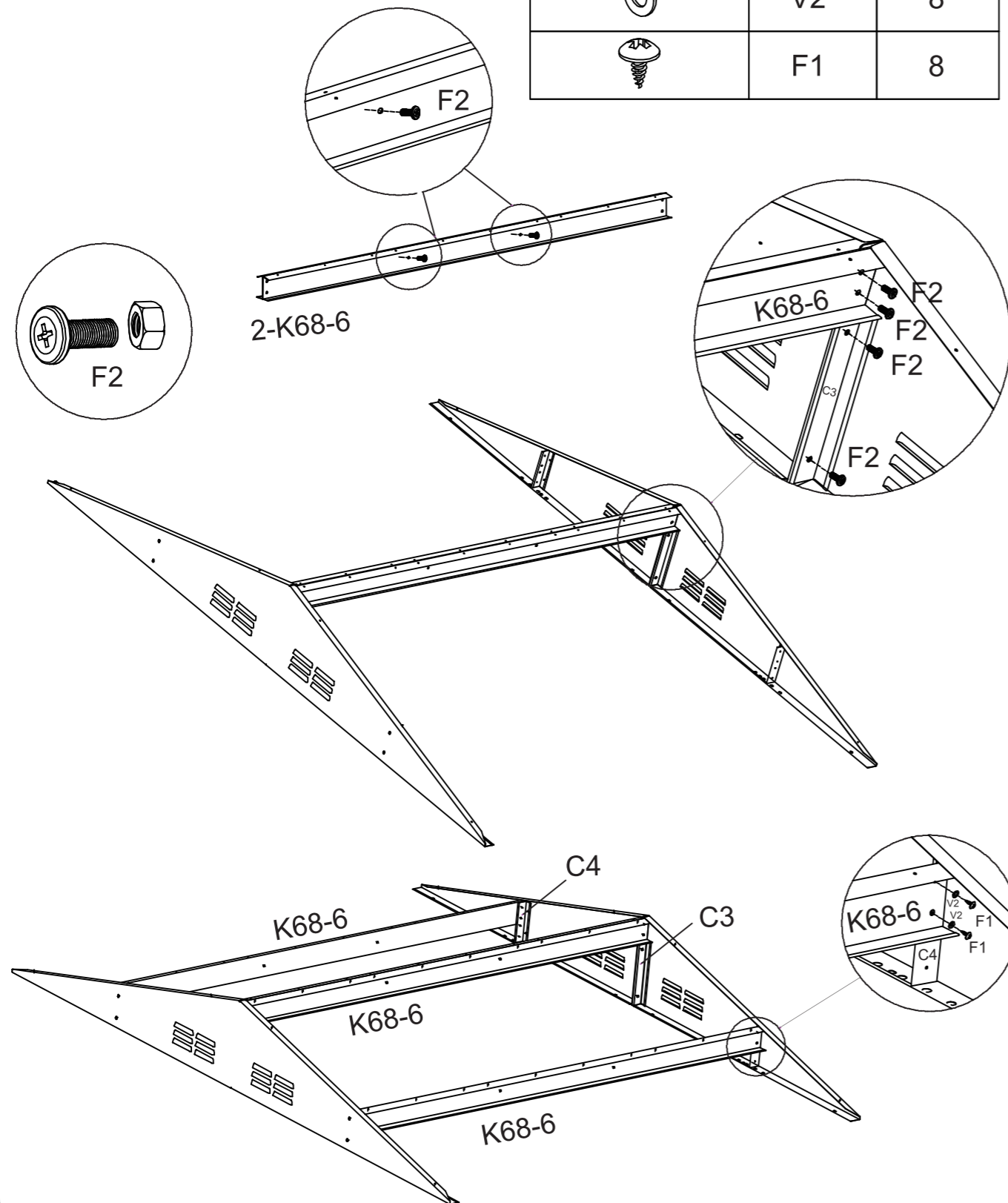





PART	NO.	QTY.
	K68-6	4
	F2	6
	V2	8
	F1	8

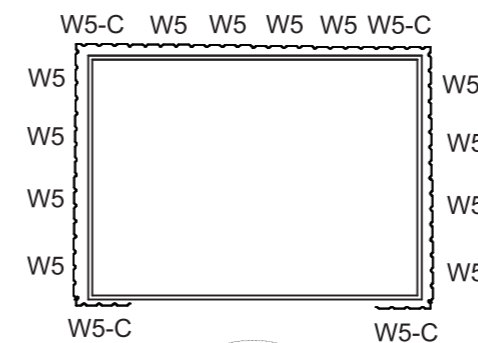
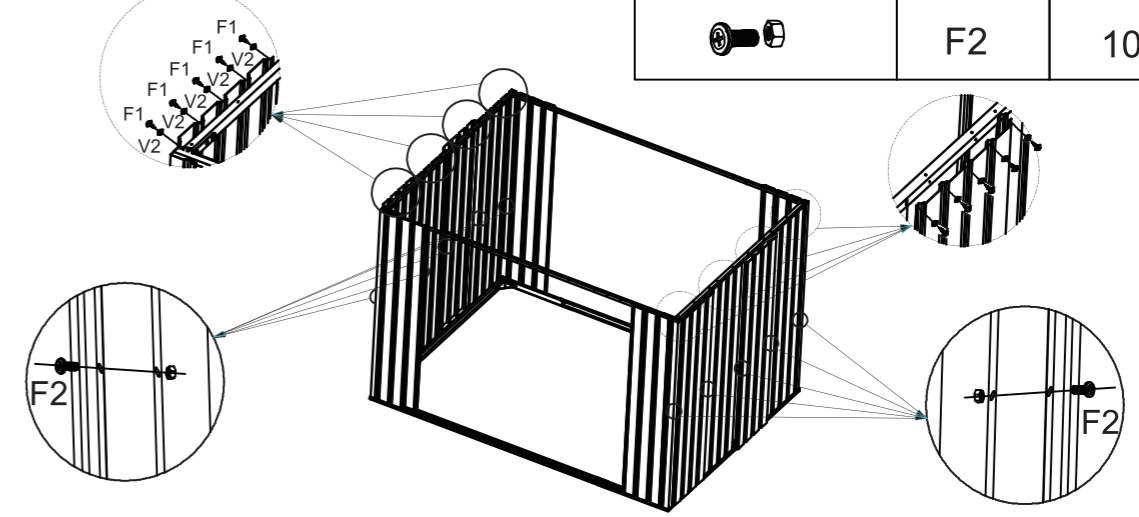

PART	NO.	QTY.
	W5	8
	V2	68
	F1	68
	F2	10



PART	NO.	QTY.
	W5	4
	V2	34
	F1	34
	F2	5

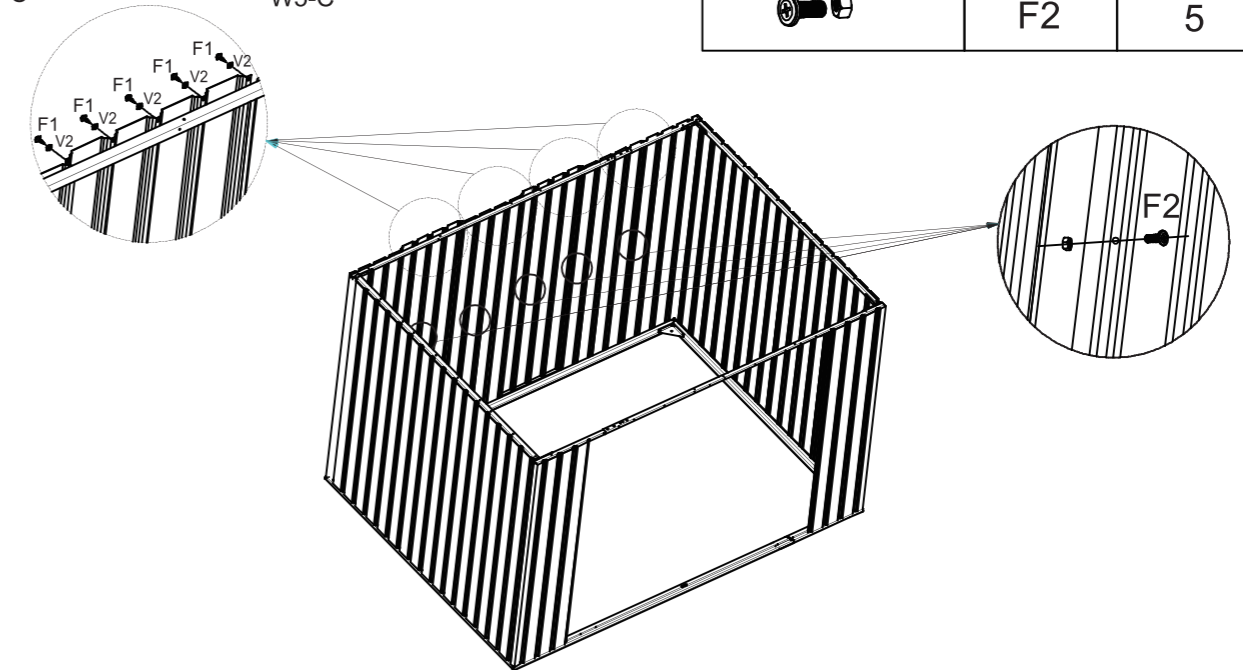

Directly covering the excess parts of the left and right panels.

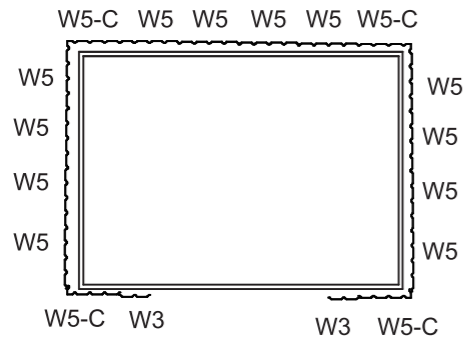

PART	NO.	QTY.
	W3	2
	V2	8
	F1	8
	F2	2

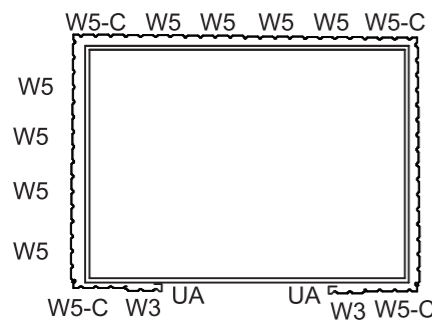
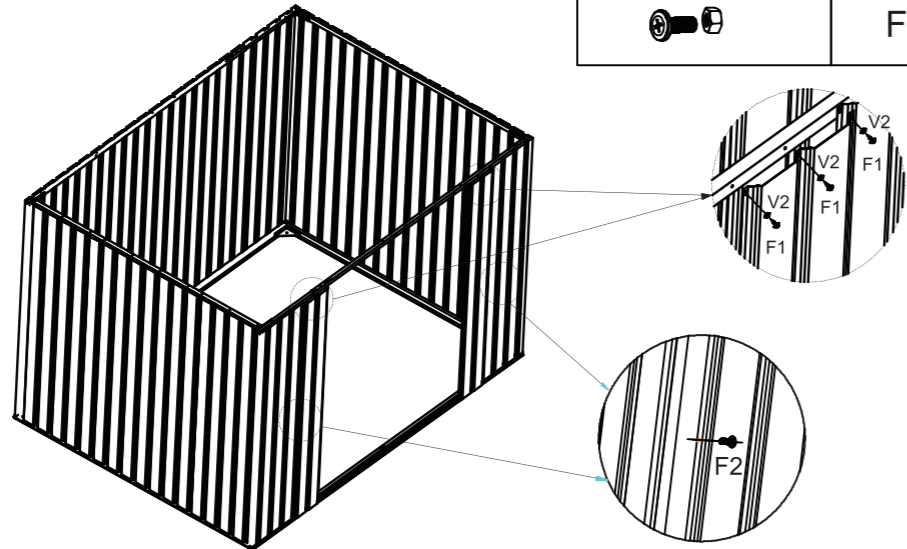

PART	NO.	QTY.
	UA	2
	V2	8
	F1	8
	F2	2

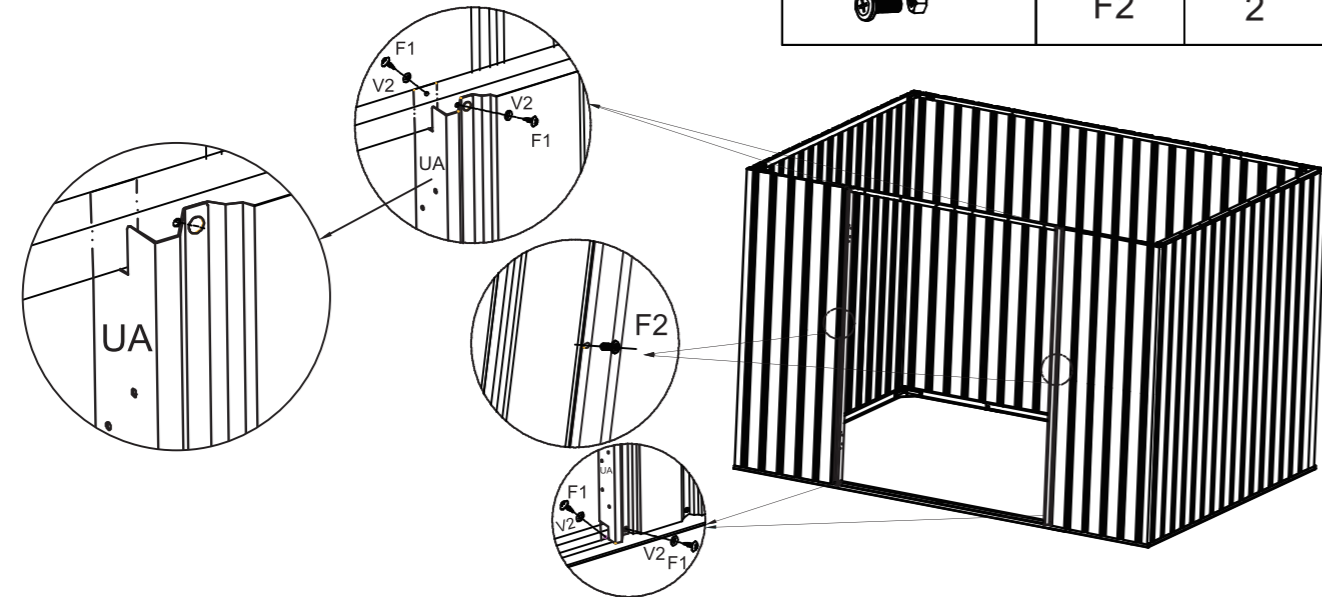

Directly covering the excess parts of the left and right panels.

Shed Top Frame Assemble

PART	NO.	QTY.
	K68-5L	2
	K68-5R	2
	C3	4
	C4	4
	F2	4
	V2	8
	F1	8

