

MODEL: IG10600084-N

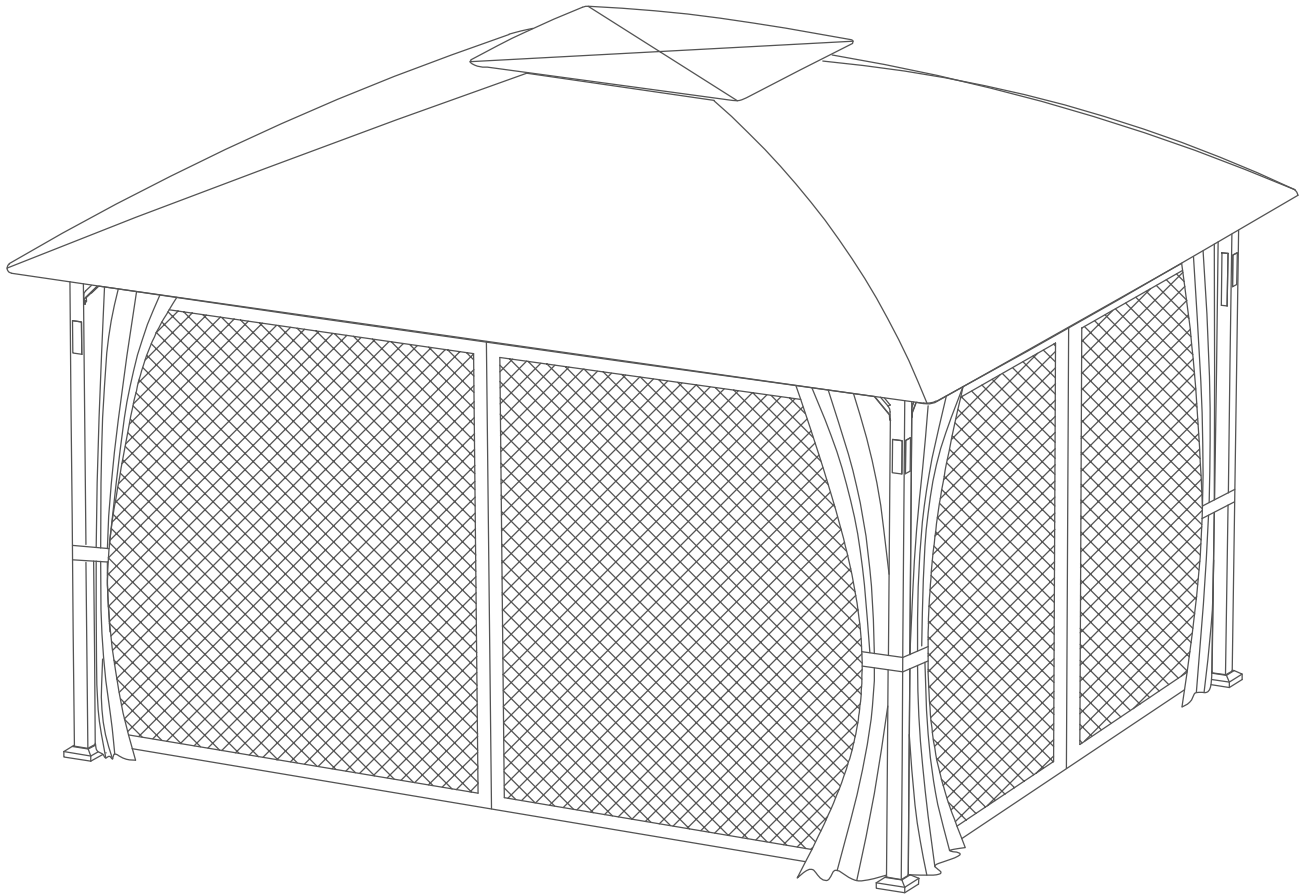

OWNER'S MANUAL

11'x13' Soft Top Gazebo w/LED lighting and Bluetooth Speaker

TABLE OF CONTENTS

ASSEMBLY GUIDE.....02
USING YOUR PRODUCT.....04

January 16, 2025

QUESTIONS?



E-mail: Support@coveredoutdoor.com













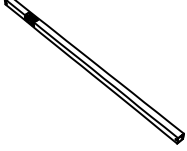
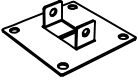
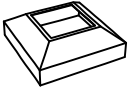



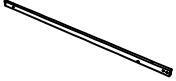
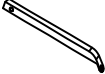

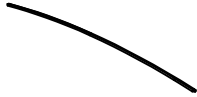
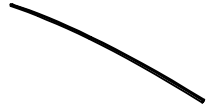

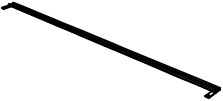
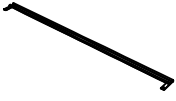

Toll Free: 888-898-2263

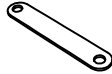

Mon-Fri: 9am---5pm PST.

ASSEMBLY GUIDE

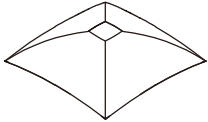
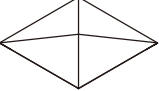
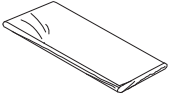
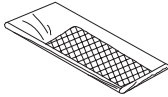
PARTS LIST

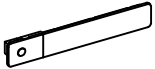
A Post (4 piece) 	B Foot Base (4 pieces) 	C Foot Cover (4 piece) 	D1 Cross Beam 1 (2 pieces) 	D2 Cross Beam 2 (2 pieces) 	D3 Cross Beam 3 (2 pieces) 
P0010005201	P0030000901	P0020000901	P0040010601	P0040010701	P0040010801
D4 Cross Beam 4 (2 pieces) 	E Support Bracket (8 pieces) 	F1 Middle Cross Beam 1 (2 pieces) 	F2 Middle Cross Beam 2 (2 pieces) 	G1 Roof Rib 1 (4 pieces) 	G2 Roof Rib 2 (4 pieces) 
P0040010901	P0050005901	P0080001601	P0080001701	P0070001901	P0070002001
G3 Roof Rib 3 (4 pieces) 	H1 Mosquito Net Rod 1 (4 pieces) 	H2 Mosquito Net Rod 2 (4 pieces) 	J1 Connector 1 (4 pieces) 	J2 Connector 2 (4 pieces) 	J3 Connector 3 (4 pieces) 
P0070002101	P0100002501	P0100002601	P0060007101	P0110003801	P0110003901
J4 Connector 4 (4 pieces) 	J5 Connector 5 (4 pieces) 	J6 Connector 6 (1 pieces) 	J7 Connector 7 (1 pieces) 	J8 Connector 8 (8 pieces) 	k Hook (1 piece) 
P0060007201	P0060007301	P0060007401	P0060007501	P0060008001	P1000001601
L1 Canopy 1 (1 pieces) 	L2 Canopy 2 (1 pieces) 	M Mosquito Netting (1 pieces) 	N Privacy Curtain (1 pieces) 	Q Bluetooth Speaker (1 pieces) 	R Battery Case (4 pieces) 
P0200000101	P0200000201	P0220001901	P0210001501	P0250000200	P0240000301

ASSEMBLY INSTRUCTIONS

•Please carefully unpack each of the components and hardware. check the components against the parts list and make sure there are no missing parts. lay pieces on cardboard or a soft mat to help protect the pieces from scratches.

⚠ CAUTION

Watch for sharp edges when handling the pieces, wear gloves to avoid injury.

- For ease of assembly, it is recommended to have 3 or more people and allow enough time to completely finish the assembly. assembly can take 6-8 hours. a step-ladder is required for assembly (not included).
- Follow step by step instructions, and follow all safety warnings provided with your tools.
- DO NOT tighten screws until all the screws and washers are properly installed. Tighten screws securely, do not over tighten.
- Gazebo should not be used in inclement weather and high winds.

STEP 01 Slide foot base **B** and foot cover **C** onto post **A** . Use two (2) **[AA]** bolts and two (2) **[DD]** flat washers to attach foot base **B** to post **A** . Repeat with the other three (3) posts **A** .

[AA] x 8
[DD] x 8

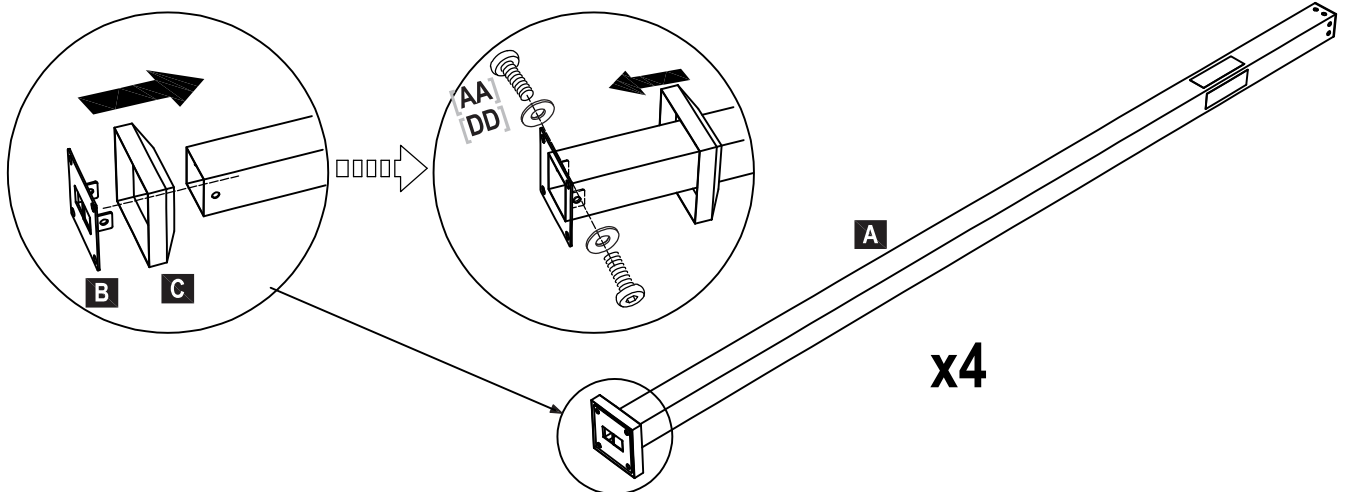

STEP 02 Slide connector **J1** into cross beam **D1** , securing with two (2) **[AA]** bolts and two (2) **[DD]** bolts. Then slide cross beam **D2** onto **J1** , securing with two (2) **[AA]** bolts and two (2) **[DD]** bolts. Finish the assembly as **D2** + **J1** + **D1** . Repeat to make a second assembly.

Use two (2) **[AA]** bolts and two (2) **[DD]** bolts to attach one (1) connector **J4** to cross beam assembly **D1D2** . Use one (1) **[AA]** bolt and one (1) **[DD]** bolt to attach connector **J2** to **D1D2** .

[AA] x 14
[DD] x 14

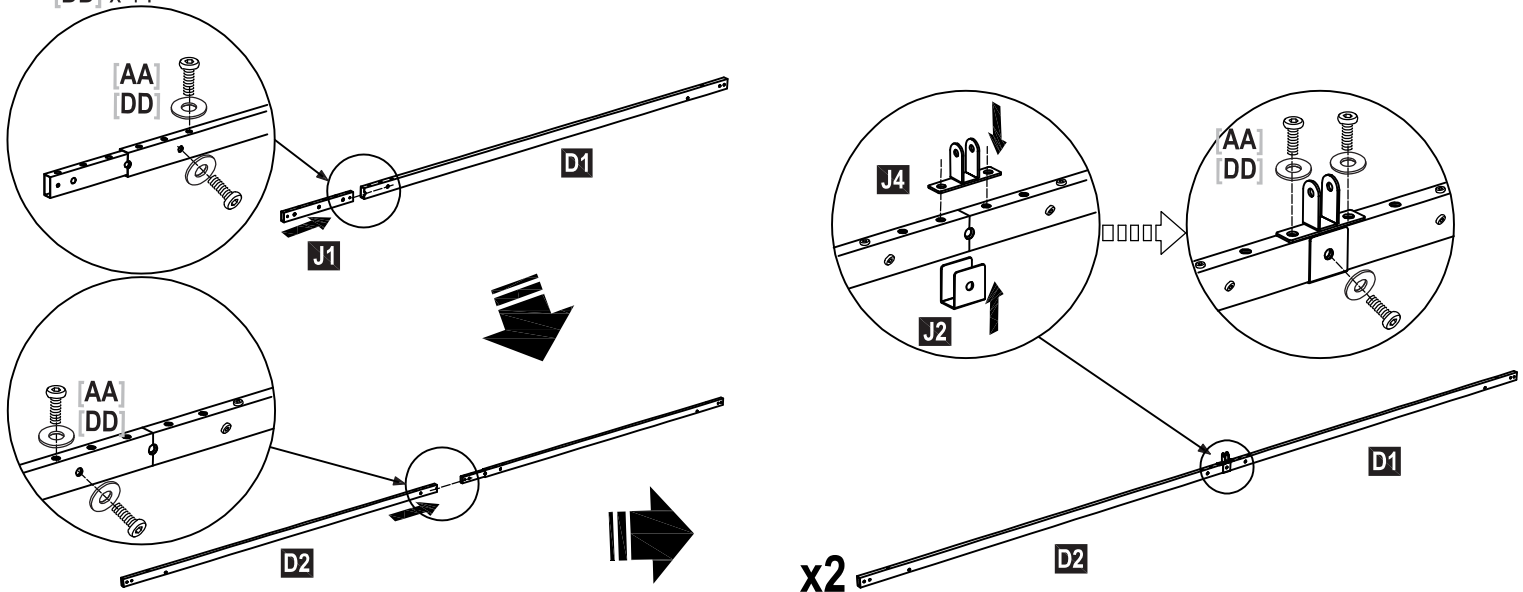

STEP 03 Slide connector **J1** into cross beam **D3**, securing with two (2) [AA] bolts and two (2) [DD] bolts. Then slide cross beam **D4** onto **J1**, securing with two (2) [AA] bolts and two (2) [DD] bolts. Finish the assembly as **D4 - J1 - D3**. Repeat to make a second assembly. Use two (2) [AA] bolts and two (2) [DD] bolts to attach one (1) connector **J4** to cross beam assembly **D3 D4**. Use one (1) [AA] bolt and one (1) [DD] bolt to attach connector **J2** to **D3 D4**.

[AA] x 14
[DD] x 14

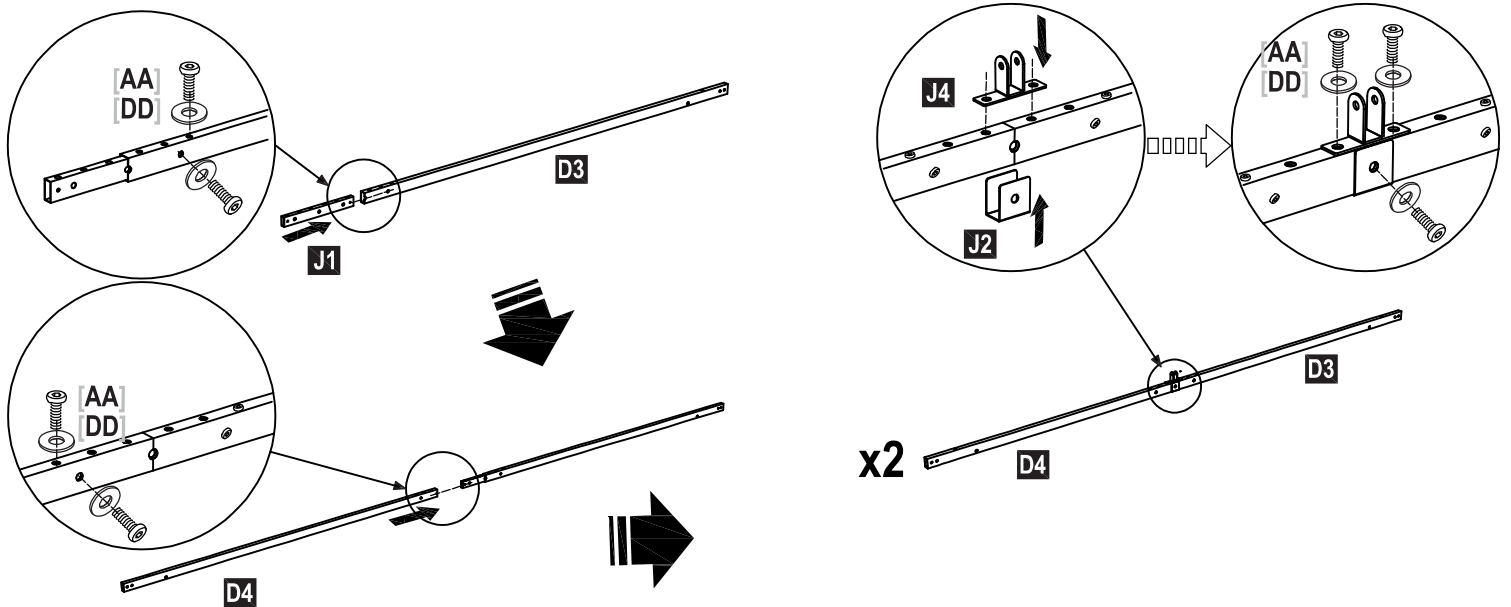

STEP 04 Use two (2) [AA] bolts and two (2) [DD] flat washers to attach each end of cross beam assembly **D1 D2** to post A. Repeat with the other assembly **D1 D2**.

[AA] x 8
[DD] x 8

