

Assembly Instruction

CAUTION: Read instruction carefully and turn electricity off at main circuit breaker panel before beginning installation.

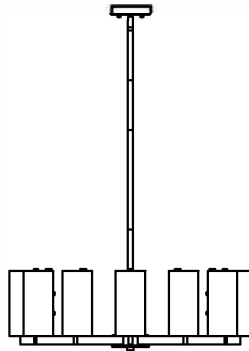

Care and Cleaning











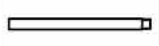

To clean the outside of the fixture, use a dry or slightly dampened clean cloth (use clean water, never a solvent) to wipe the surface of the fixture.

To clear the inside of the fixture, first disconnect power to the fixture by turning off the circuit breaker or by removing the fuse at the fuse box. Next, use a dry or slightly dampened clean cloth (use clean water, never a solvent) to wipe the interior surface of the fixture.

Do not use any cleaners with chemical, solvents or harsh abrasives. Use Only a dry soft cloth to dust or wipe carefully.

Estimated Assembly Time: 30 minutes

Part List and Hardware List

PIECE	DESCRIPTION	PICTURE	QUANTITY	PIECE	DESCRIPTION	PICTURE	QUANTITY
A	Mounting Plate		1X	H	Short Stem		2X
B	Machine Screw		2X	I	Long Stem		2X
C	Mounting Screw		2X	J	Light Body		1X
D	Wire Connector		3X	K	Bulb		12X
E	Canopy Nut		2X	L	Clear Glass		12X
F	Ground Screw		1X	M	Coronet Screw		24X
G	Canopy		1X				

Instruction

Step 1

Unpack all parts from cartons carefully.

Fix the Mounting Plate(G) to the junction box with Mounting screw(H).

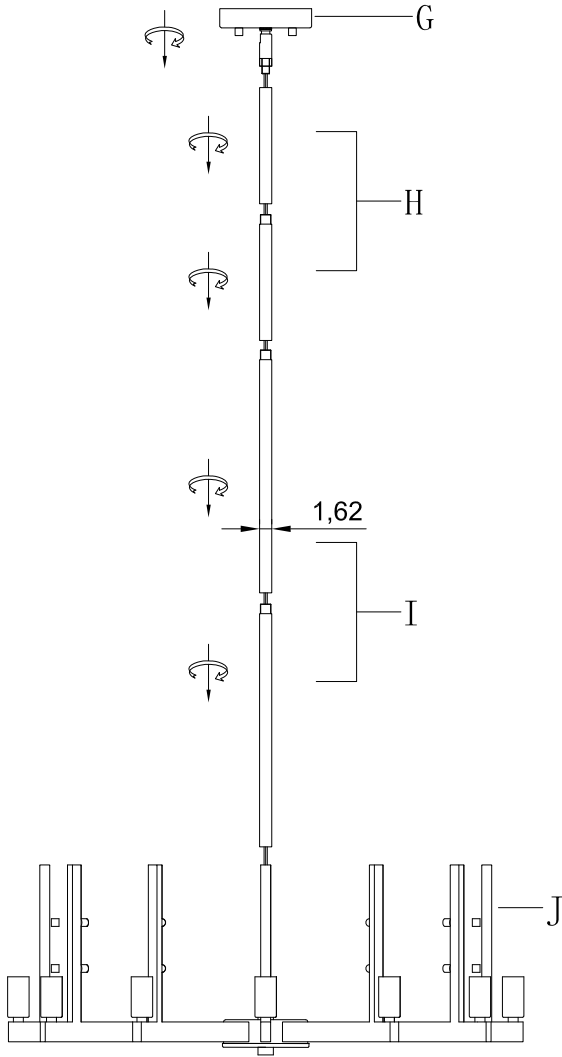
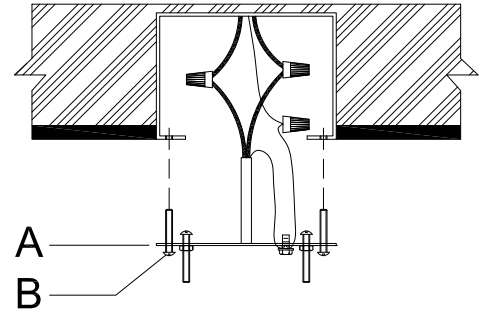

Step 2

Screw the long stem(I) and Short Stem (H) to the Lamp Body (J). Make sure to feed the branchwires of the fixture through the stems during assembly. Remove or add stems to adjust the height. Then screw the canopy (G) to the stem.

Step 3 Wire connection

Connect, Hot, Black or Red outlet Supply Wire to:	Connect, Neutral, White Outlet Supply Wire to:
Black	White
*Parallel Cord(round&smooth)	*Parallel Cord(square&ridged)
Clear, Brown, Gold or Black without Tracer(colored stripes)	Clear, Brwn, Gold or Black without Tracer(colored stripes)
Insulated Wire(not green)with copper metal conductor	Insulated Wire(not green)with Silver metal conductor

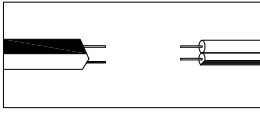

*Note: When parallel wire(SPTI&SPTII)is used. The neutral wire is square shaped and ridged and the hot wire will be round in shape and smooth.(See illustration on left)

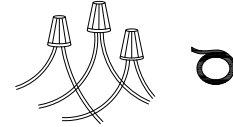

Grounding Instructions:

a) For installation in the United States: Wrap ground wire from outlet box around green ground screw on mounting bracket, no less than 2" from wire end. Tighten ground screw. If fixture is supplied with a ground wire, connect to outlet ground wire with a wire connector.

b) For installation in Canada: If fixture is supplied with ground wire, wrap ground wire around green grounding screw on mounting bracket. Tighten ground screw.

Step 4

Attach the Canopy (G) to the Mounting Plate (A),and fix it by turning the Canopy Nut (E) clockwise. Insert the light bulb (K) into the lamp body(J) Insert the glass shade (L) on the lamp body (J),then tighten it with the crown nut (M).

**PLEASE USE ON/OFF TYPE "B" BULB MAX 25-WATT OR CFL BULB MAX 13-WATT OR LED BULB MAX 9-WATT
THERE IS LED 4-WATT BULB IN THE BOX**

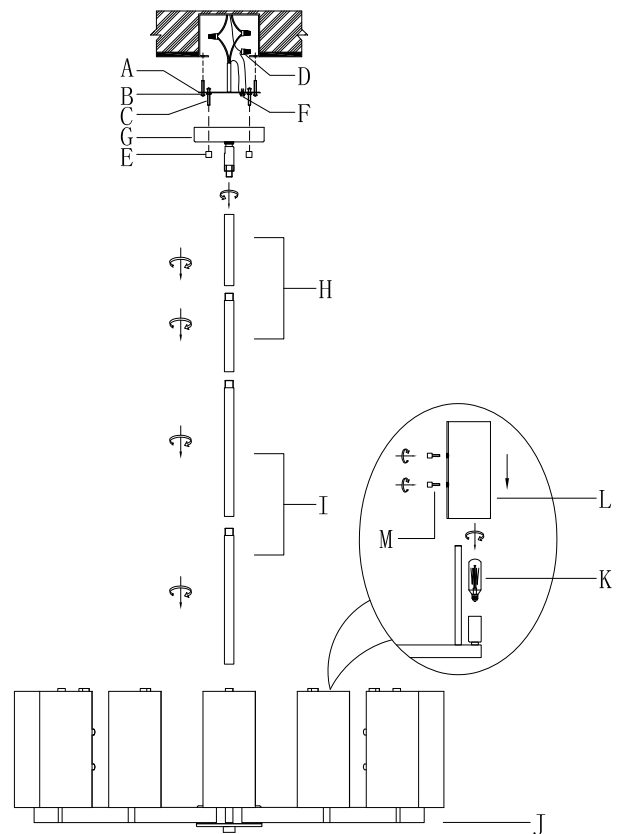

Step 5

Consult a qualified electrician to ensure correct branch circuit conductor.

ENJOY YOUR LAMP