

Installation Manual

TSQAL22-48IN

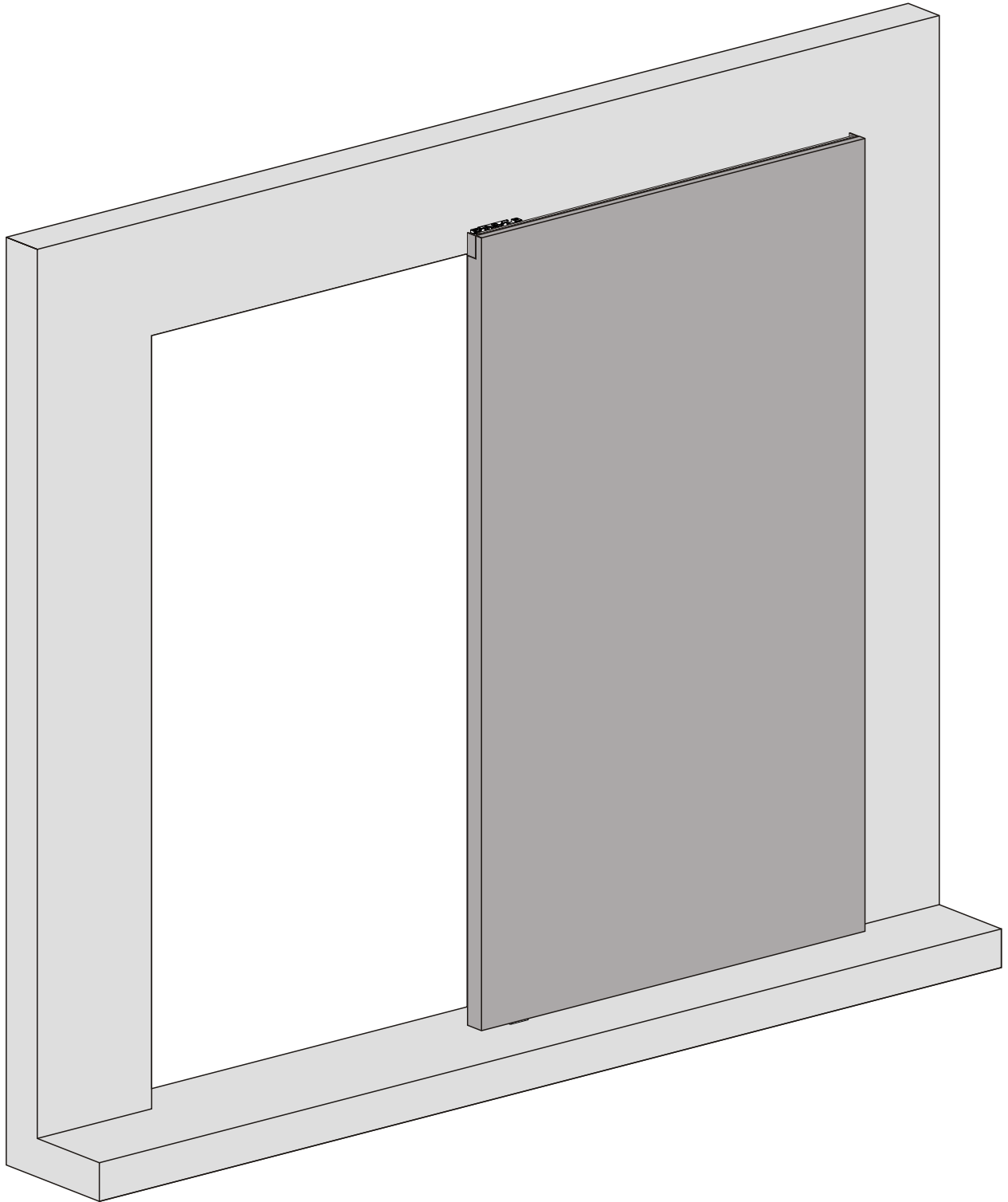

Components list

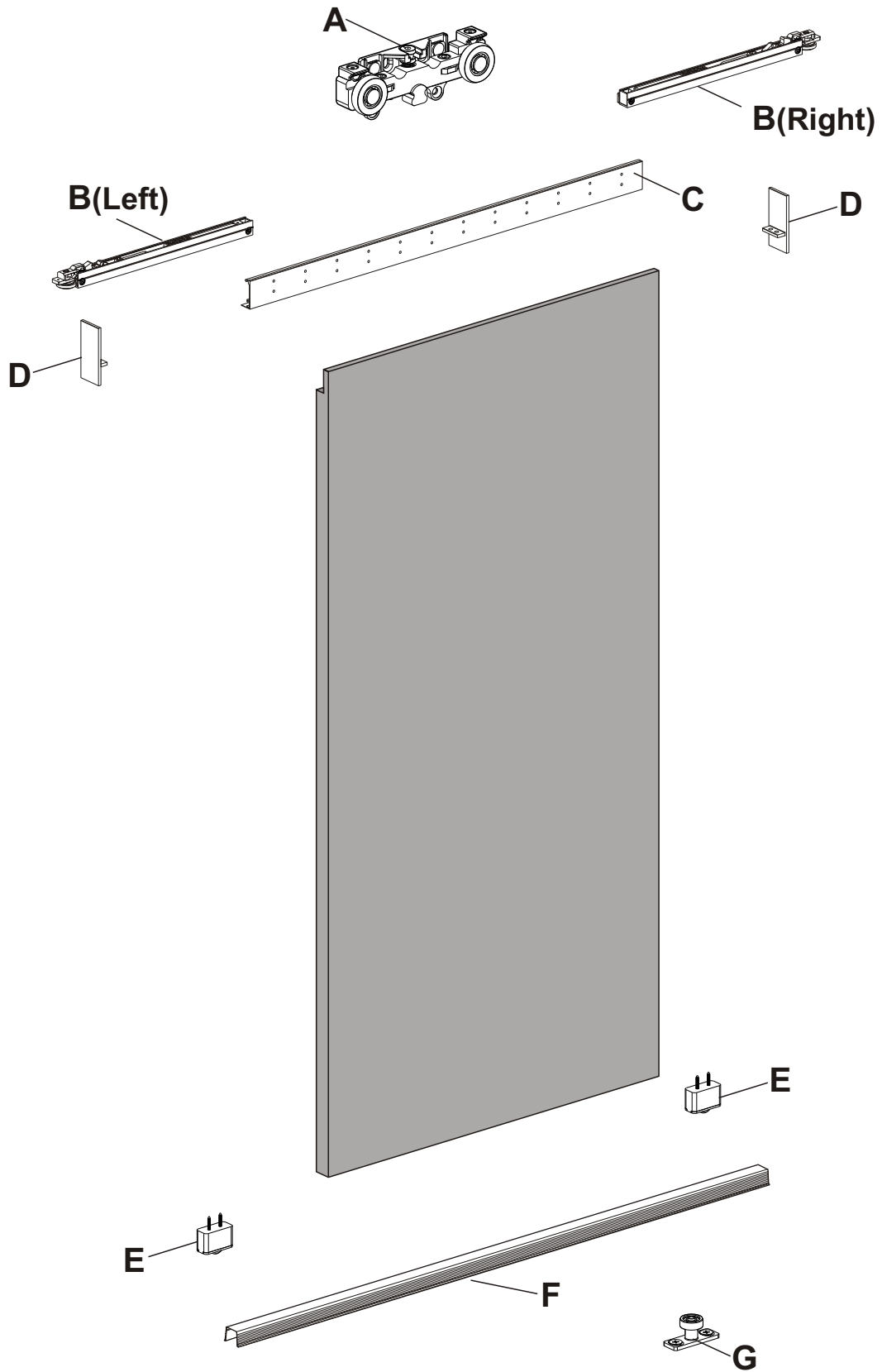

Pre-installation

TOOLS REQUIRED

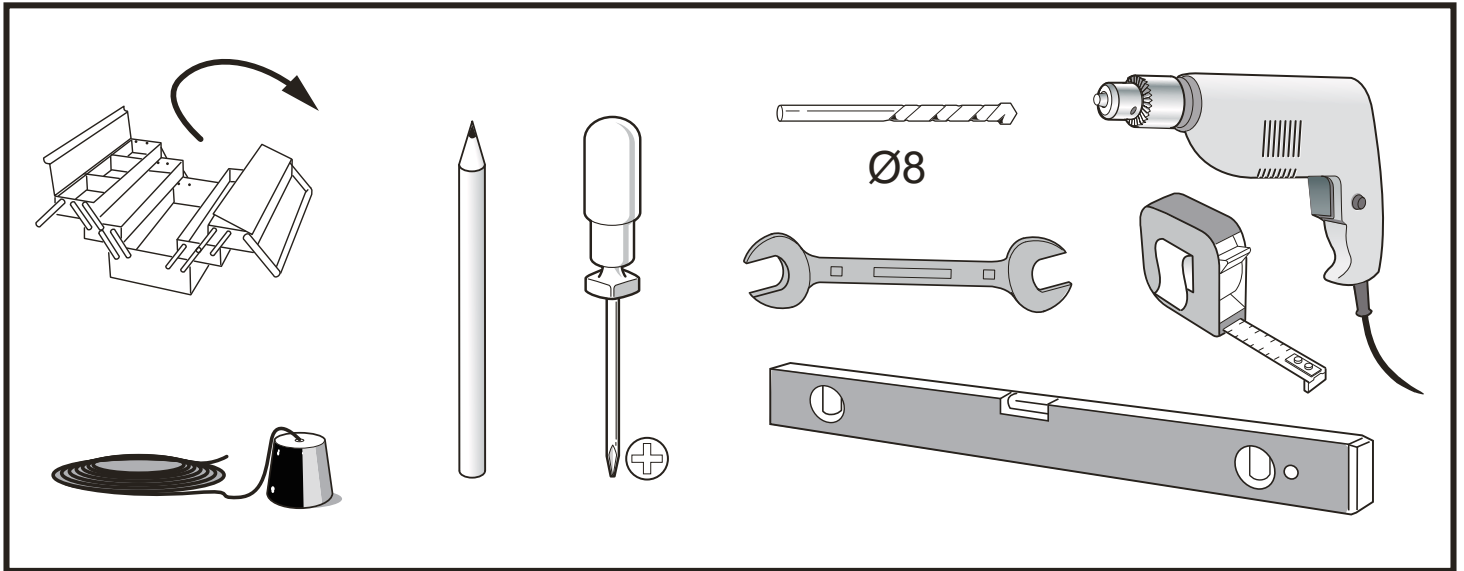

HARDWARE INCLUDED

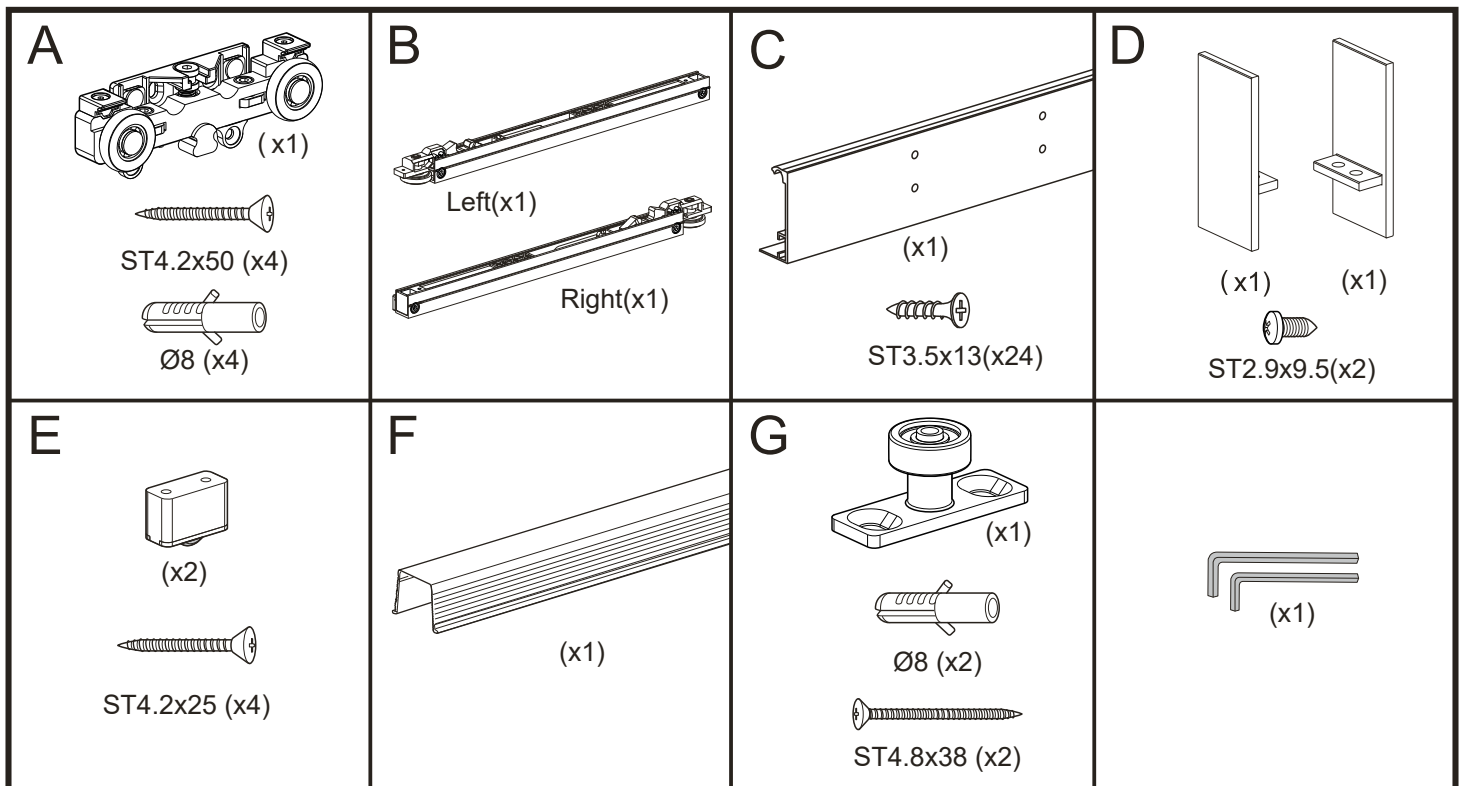

To provide feedback on a particular part, please mark it by circling in the instruction manual and kindly send us a photo.

Door preparation.a

DW	Door Width
PD	Passage Width
DH	Door Height
PH	Passage Height
MH	Hanger Positioning

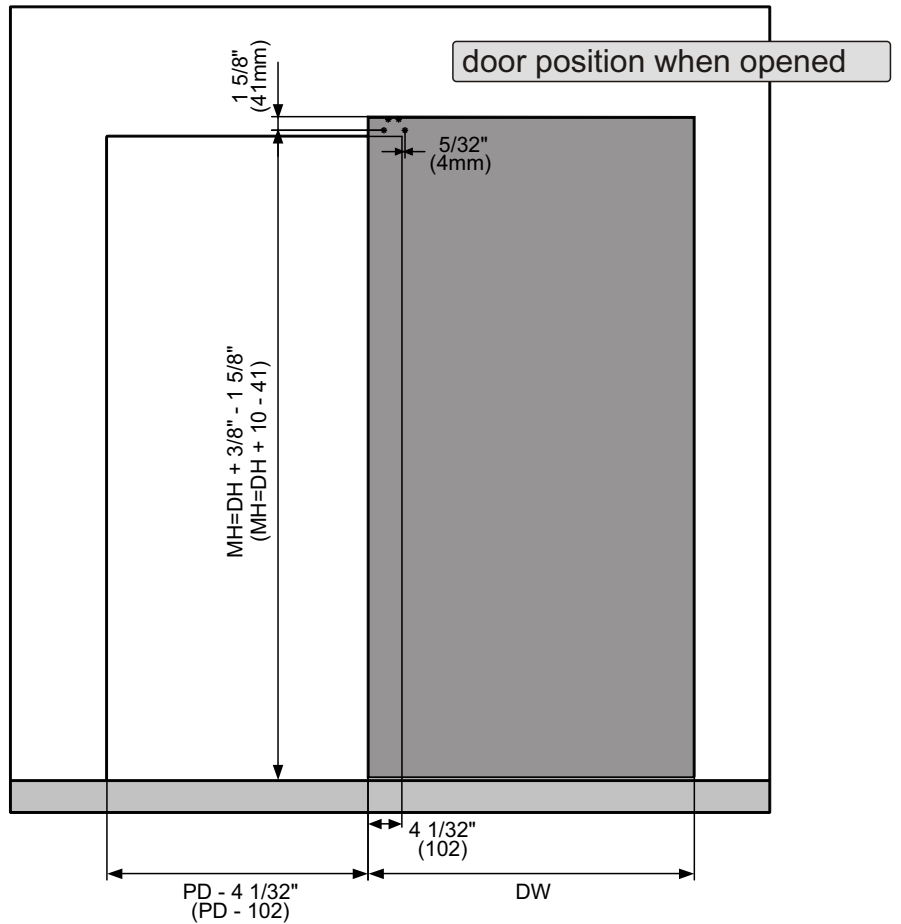
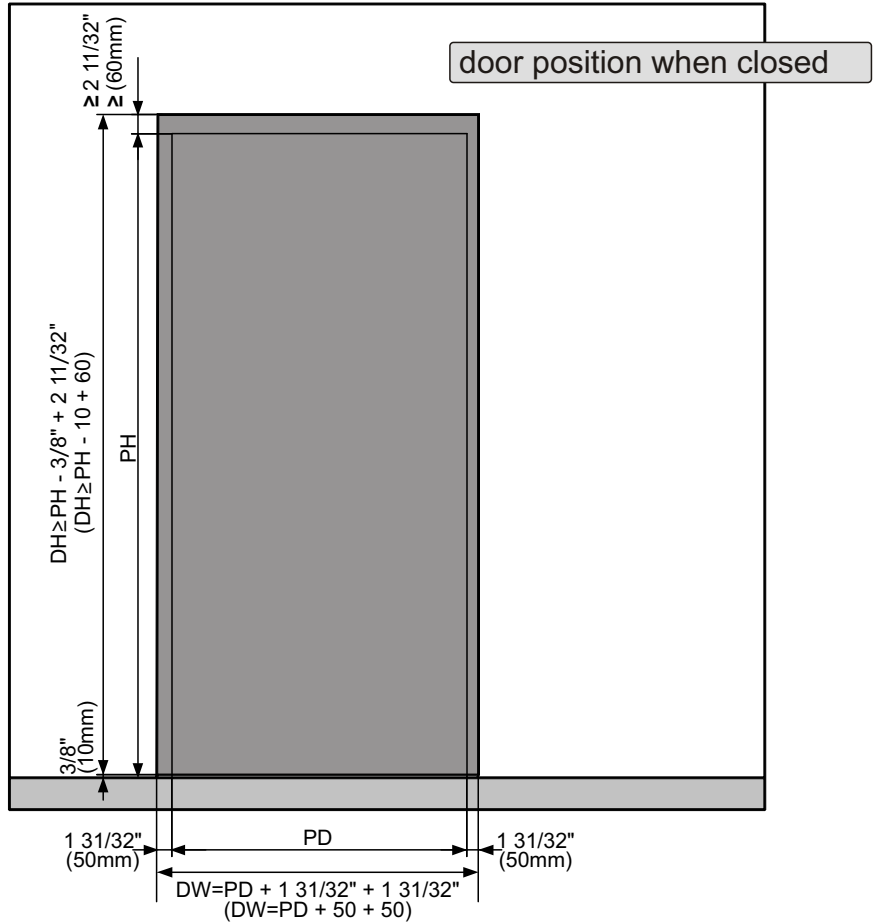

Door preparation.b

DW	Door Width
PD	Passage Width
DH	Door Height
PH	Passage Height
MH	Hanger Positioning

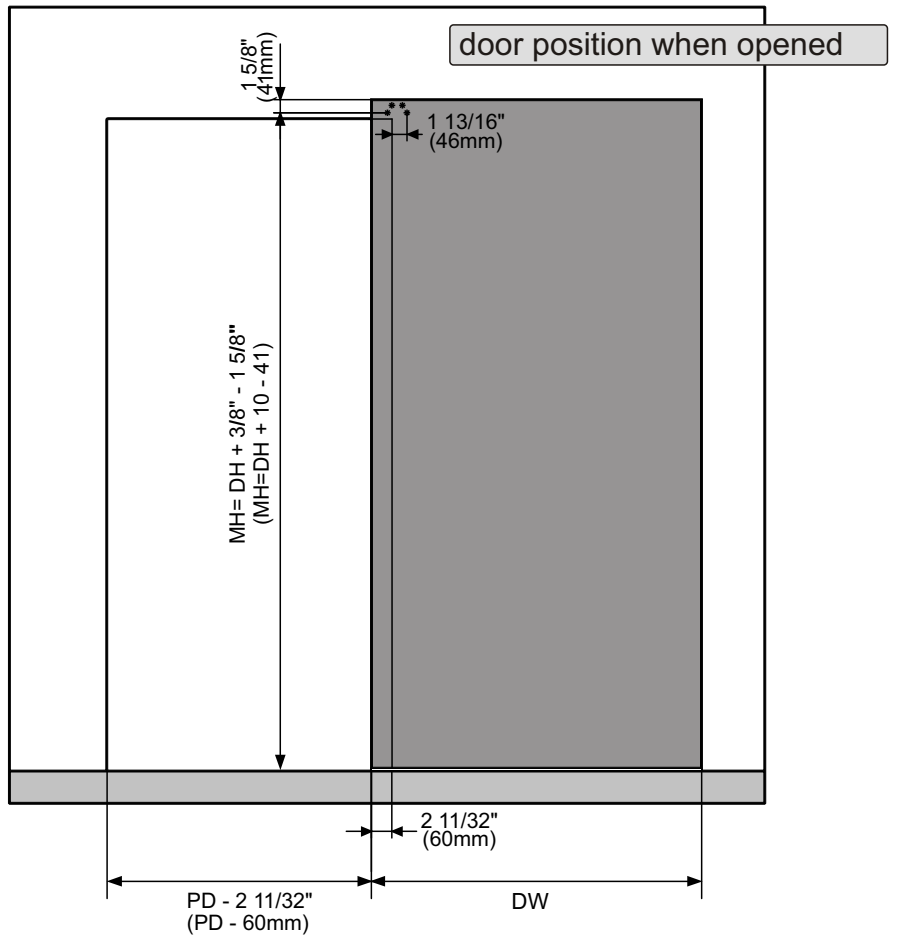
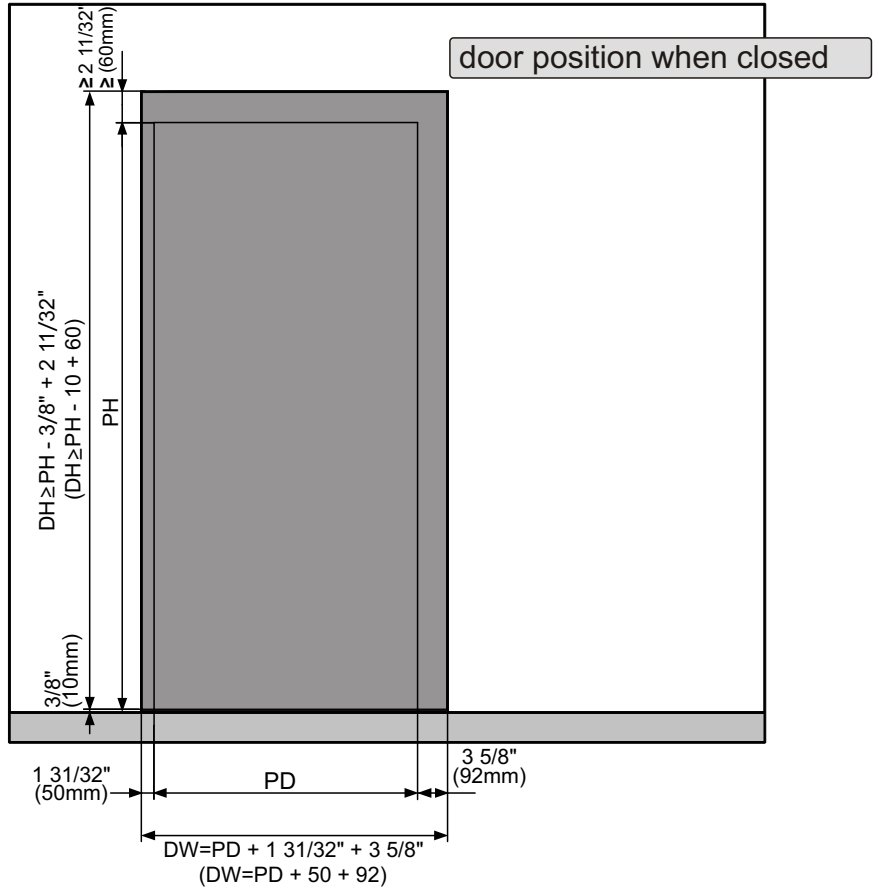

Door preparation.c

DW	Door Width
PD	Passage Width
DH	Door Height
PH	Passage Height
MH	Hanger Positioning

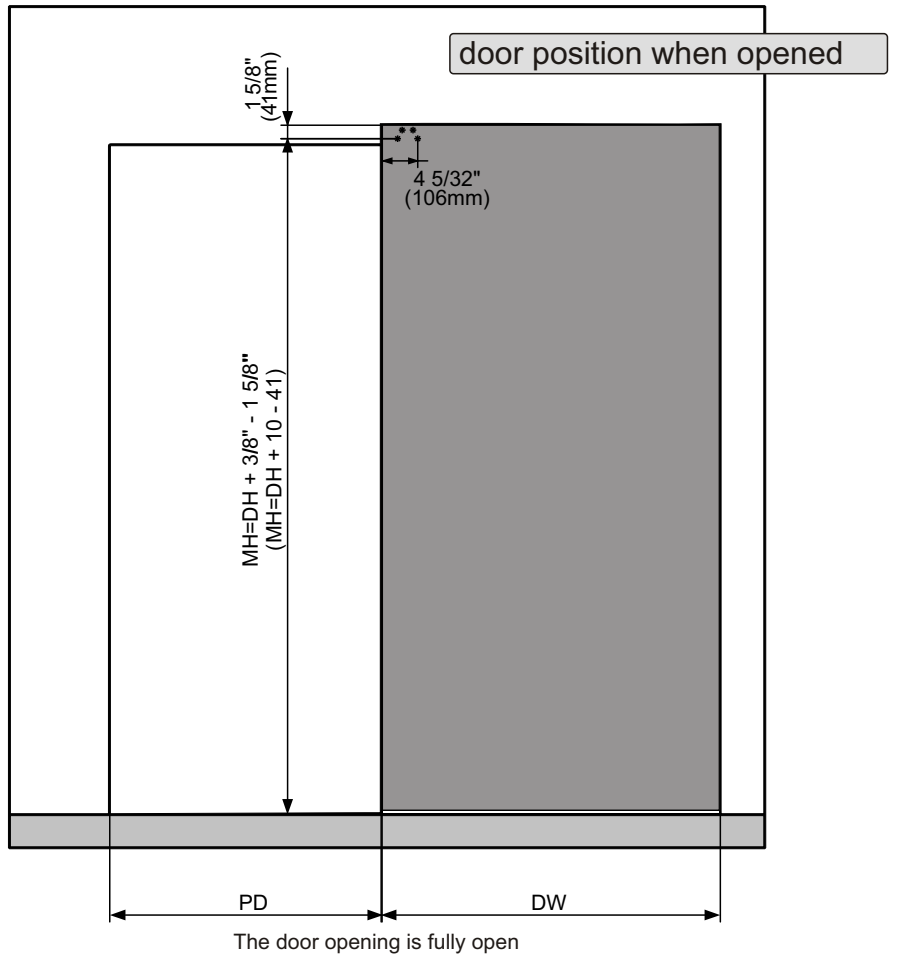
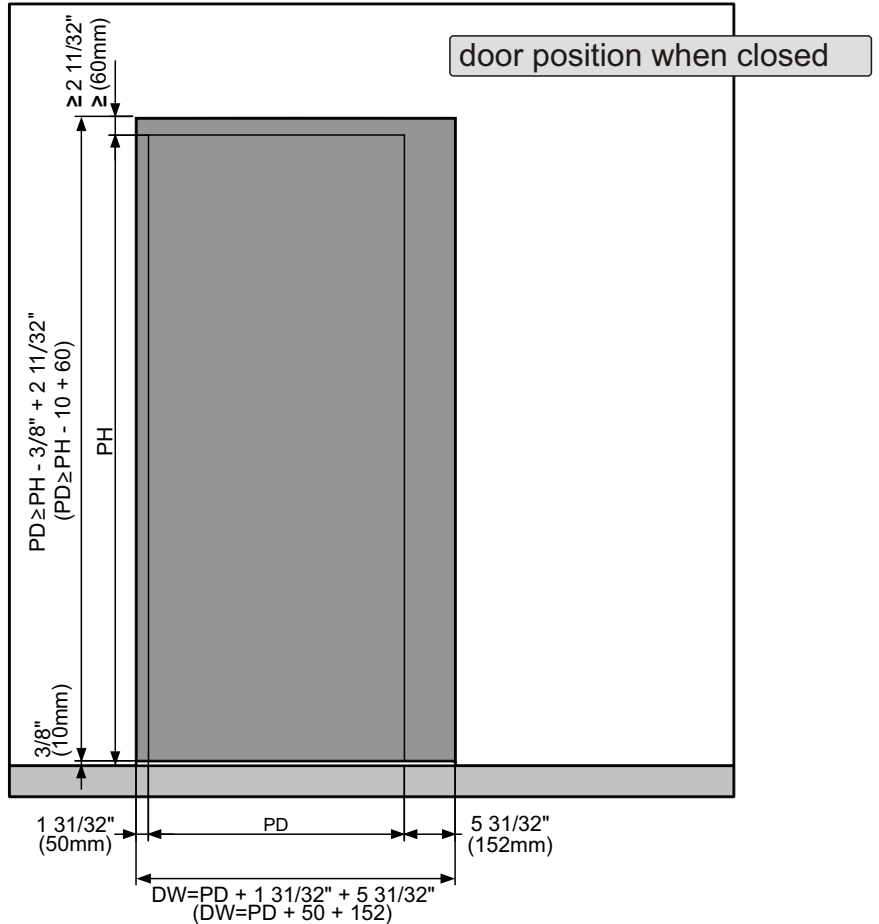

Components position

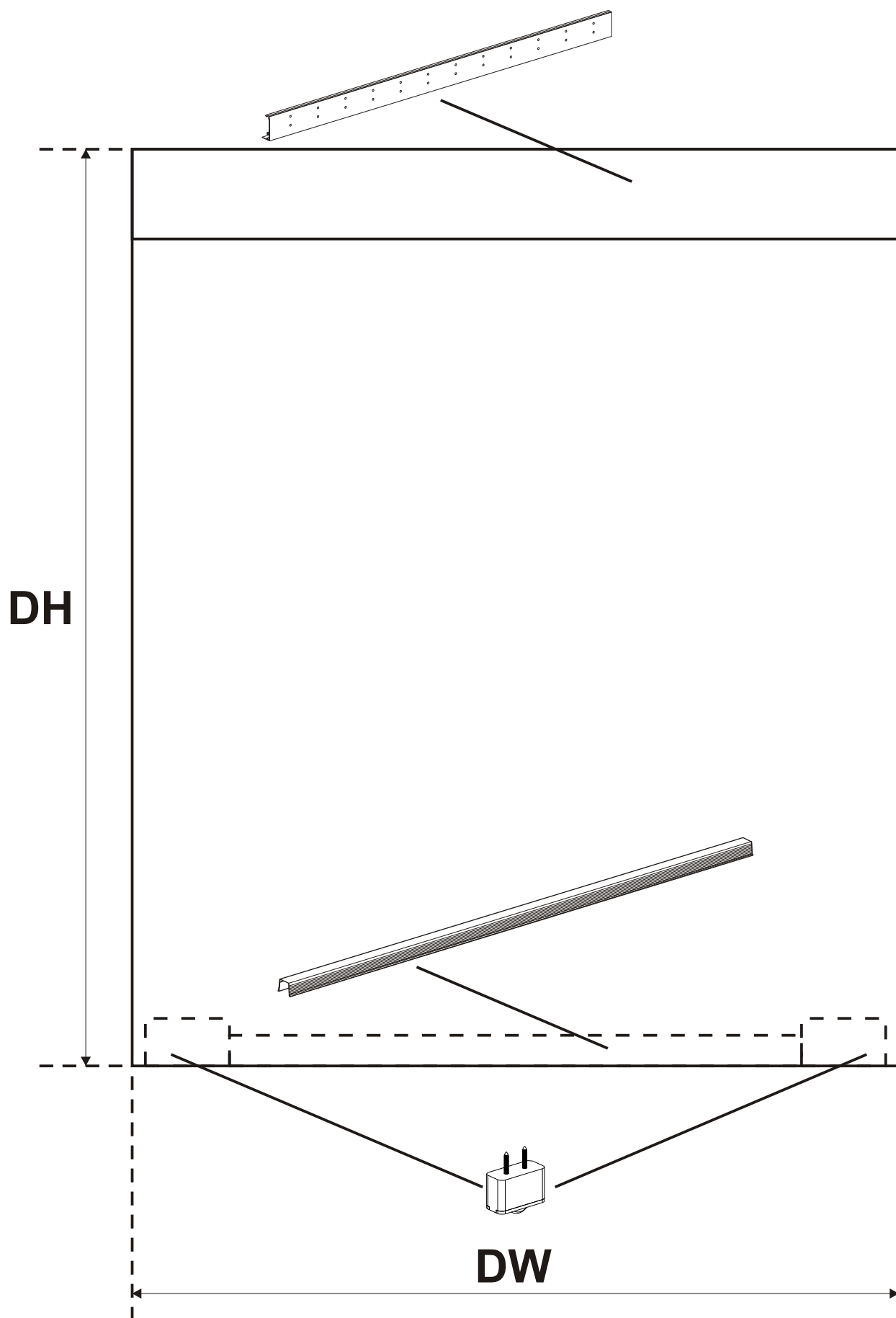

Open top and bottom slots

Top Track

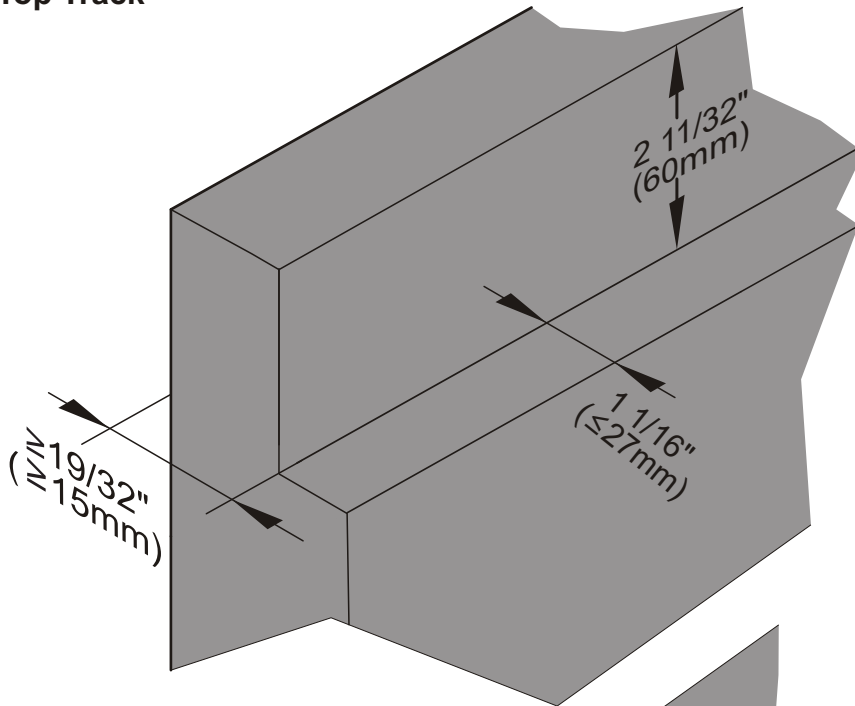

Bottom Slot

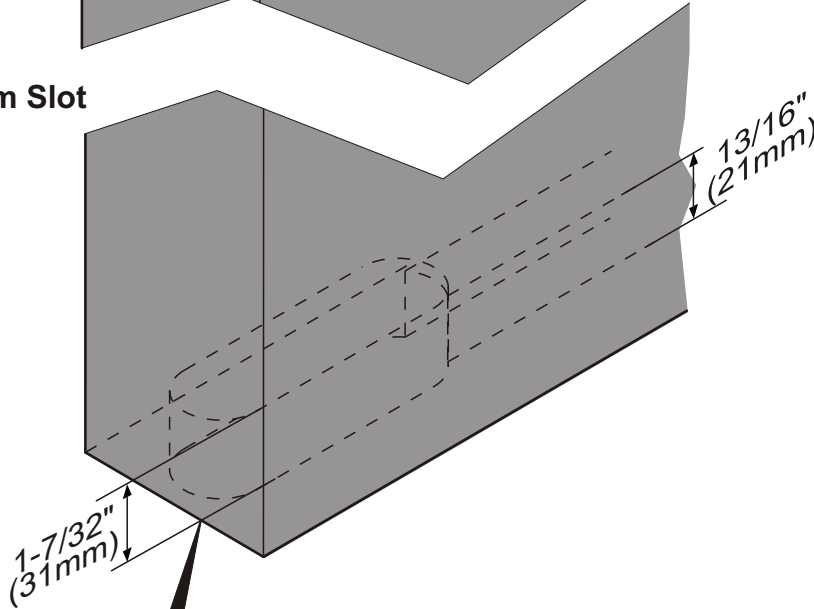

Tool

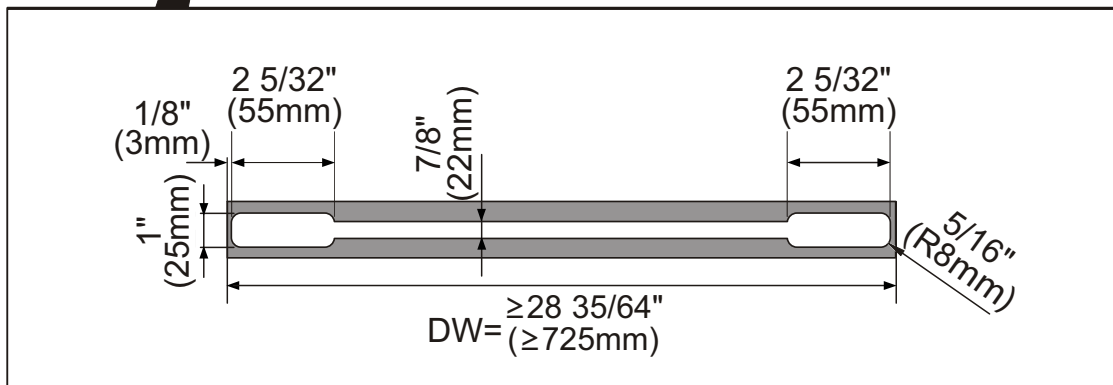
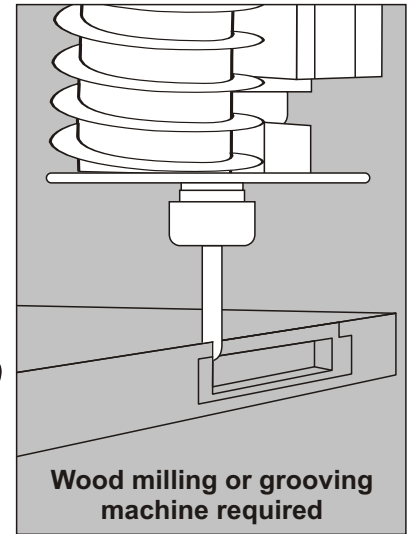

Section drawing

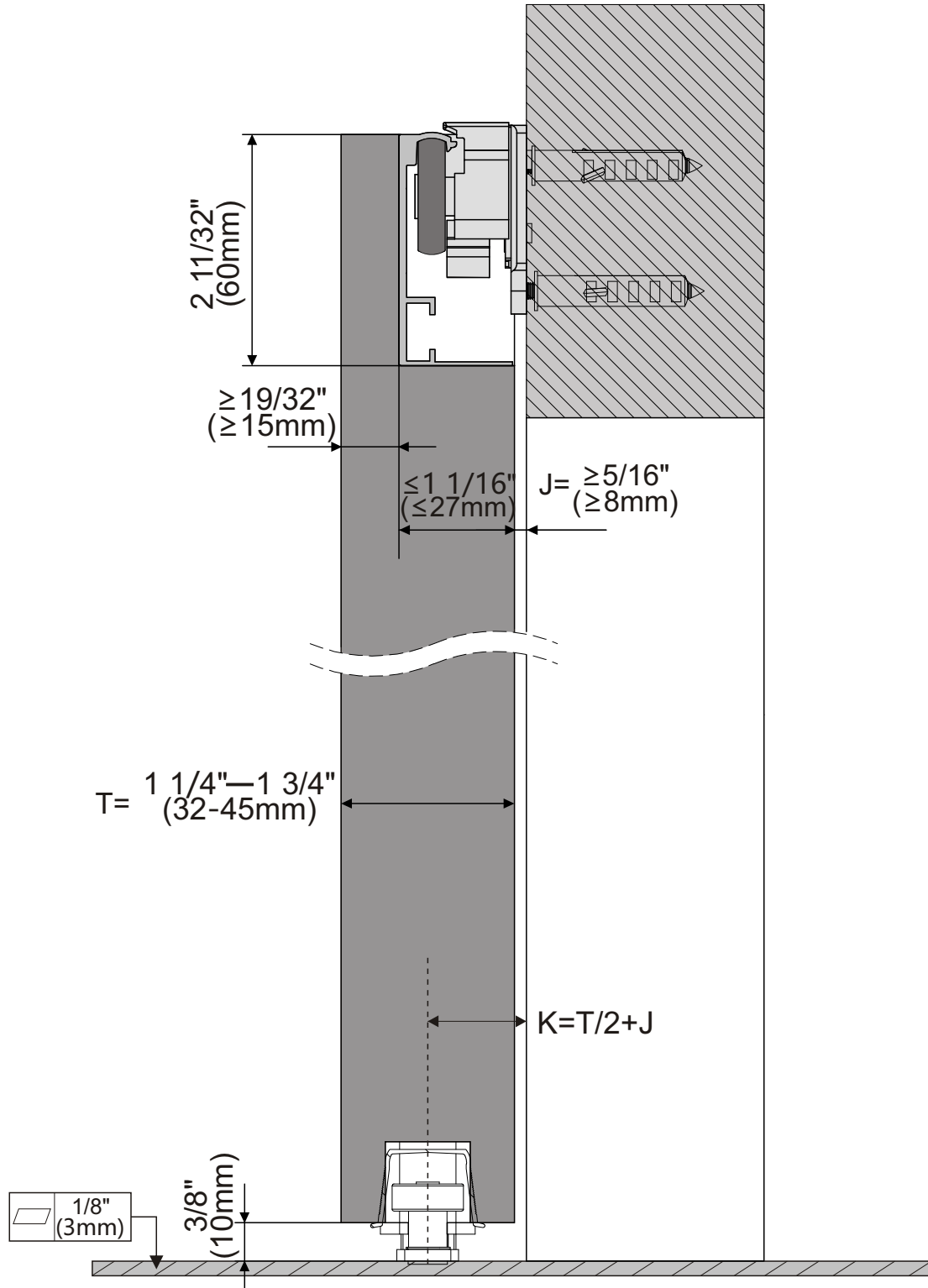

Installation

1 Fasten top track onto the door slot.

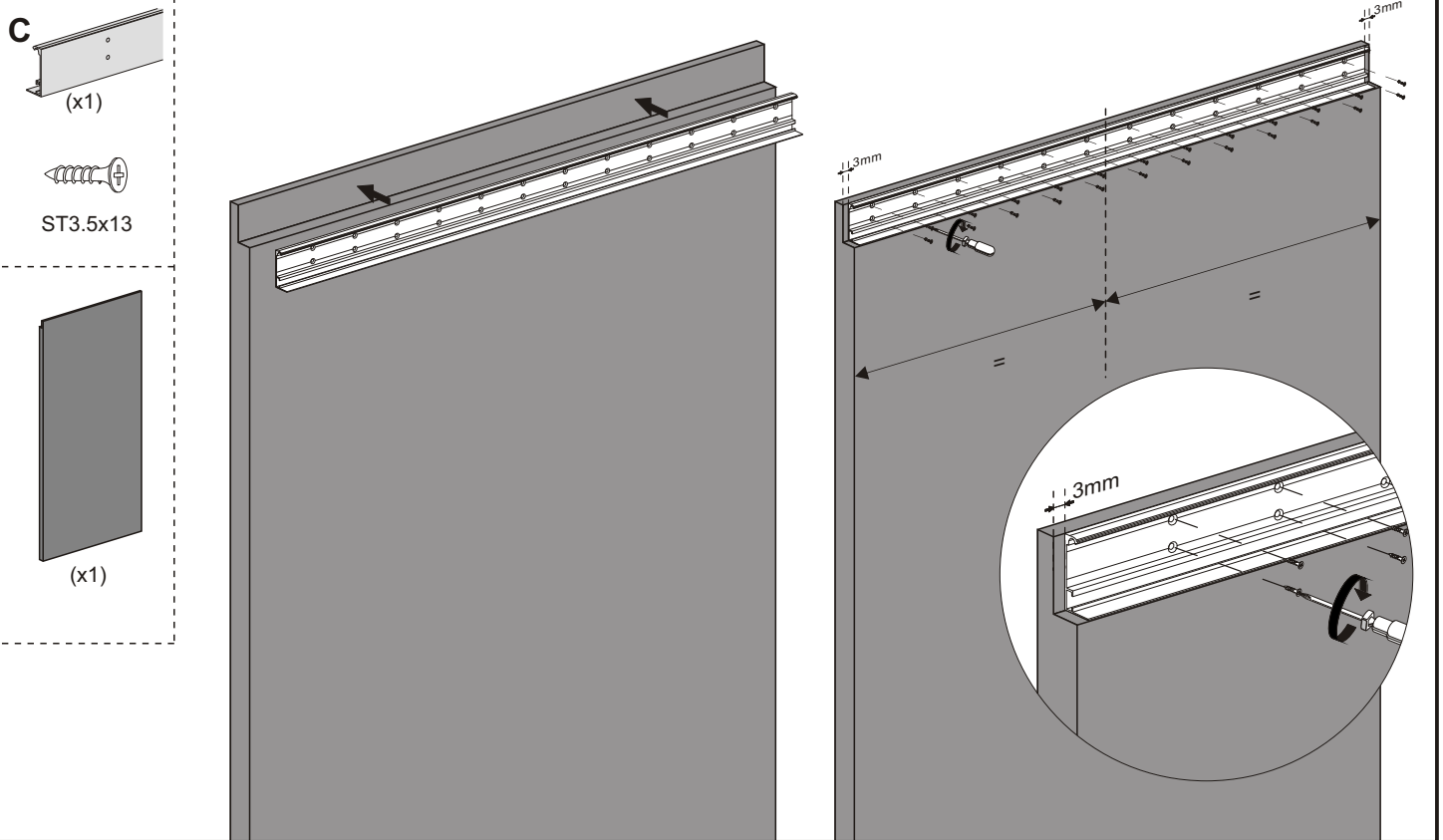

2 loosen the soft close screws and put both soft closes on both ends of top track.

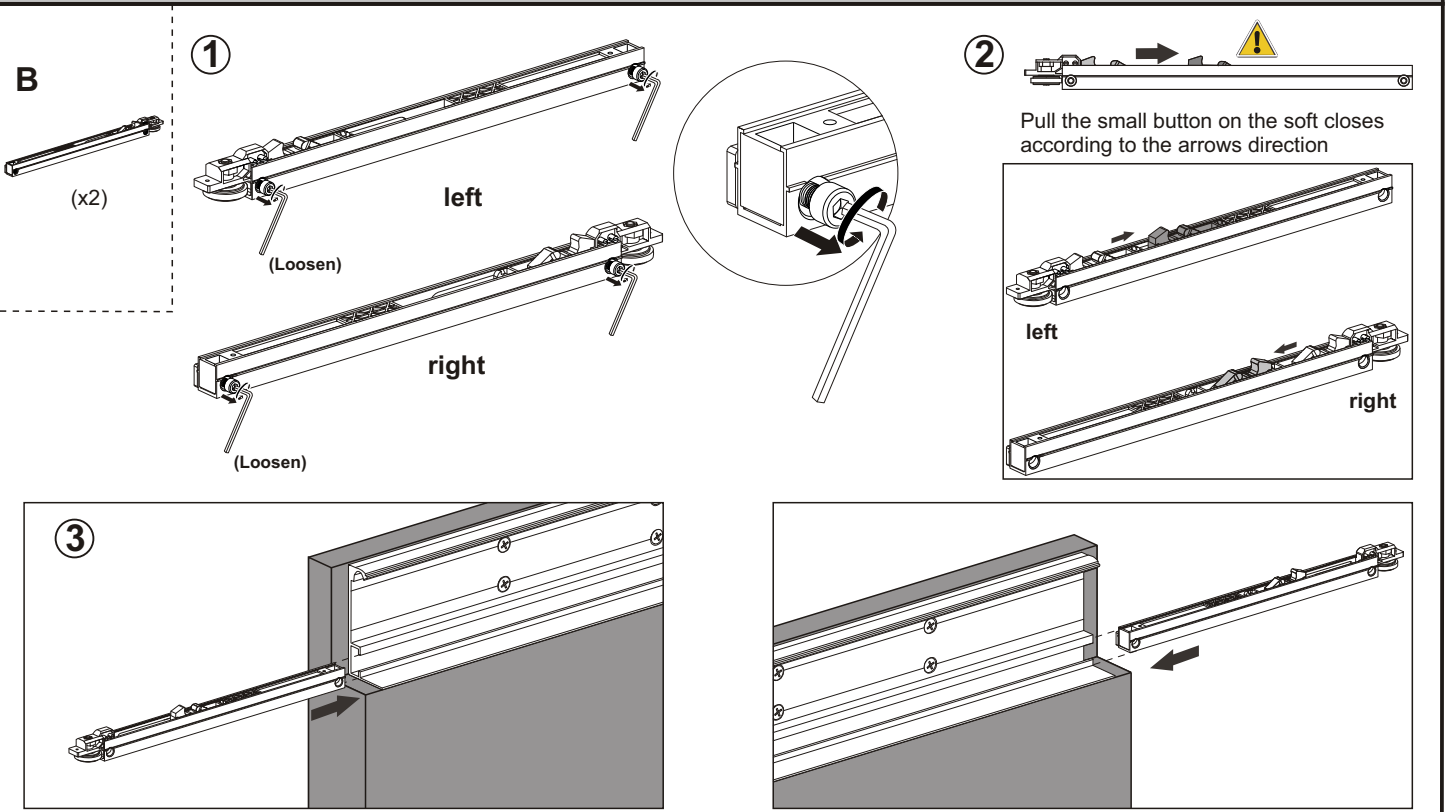

3 Ensure soft close is even with either end of track and tighten soft close screws.

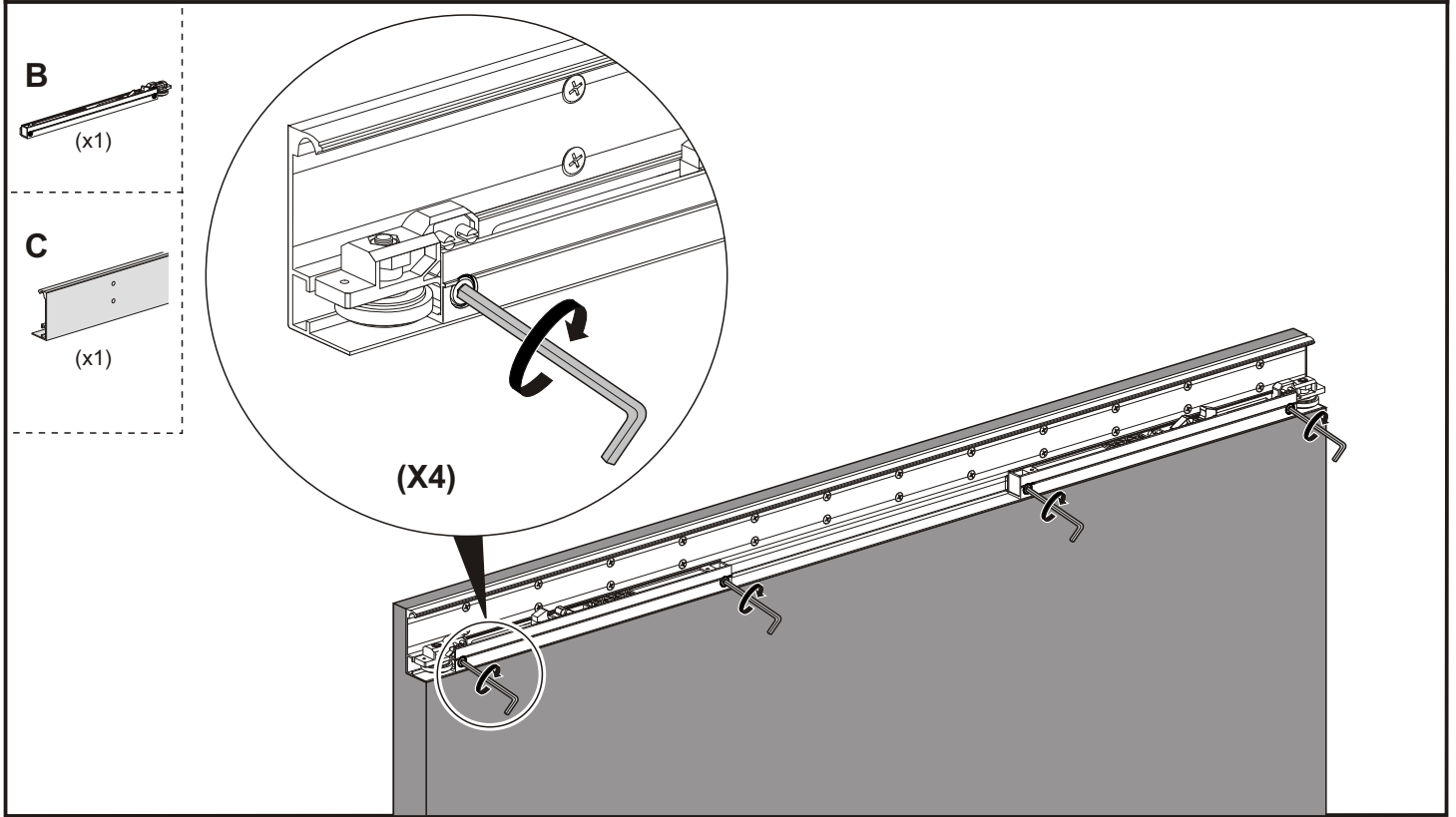

4

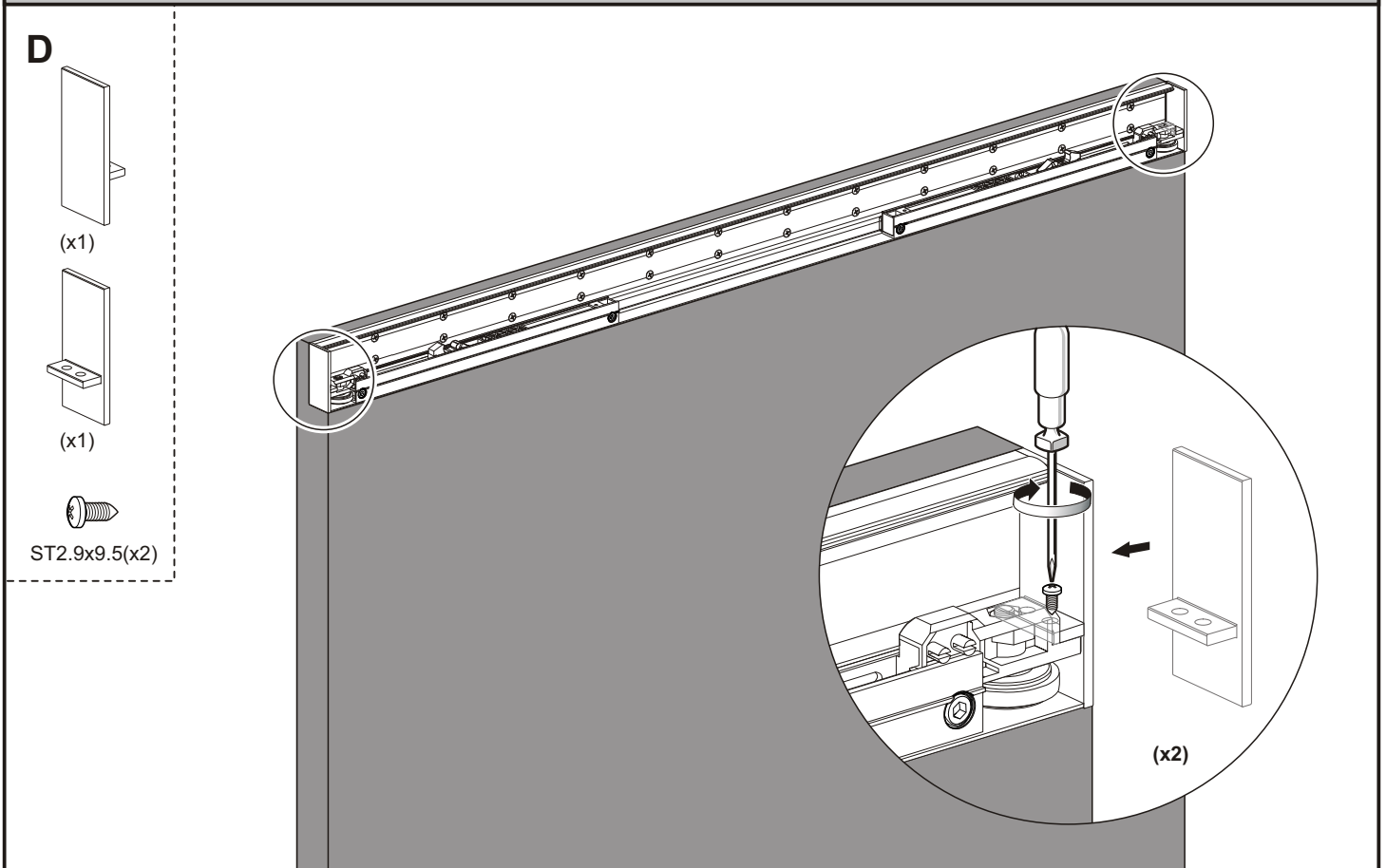

5 Remove the wheel.

E



(x2)



ST4.2x25 (x4)

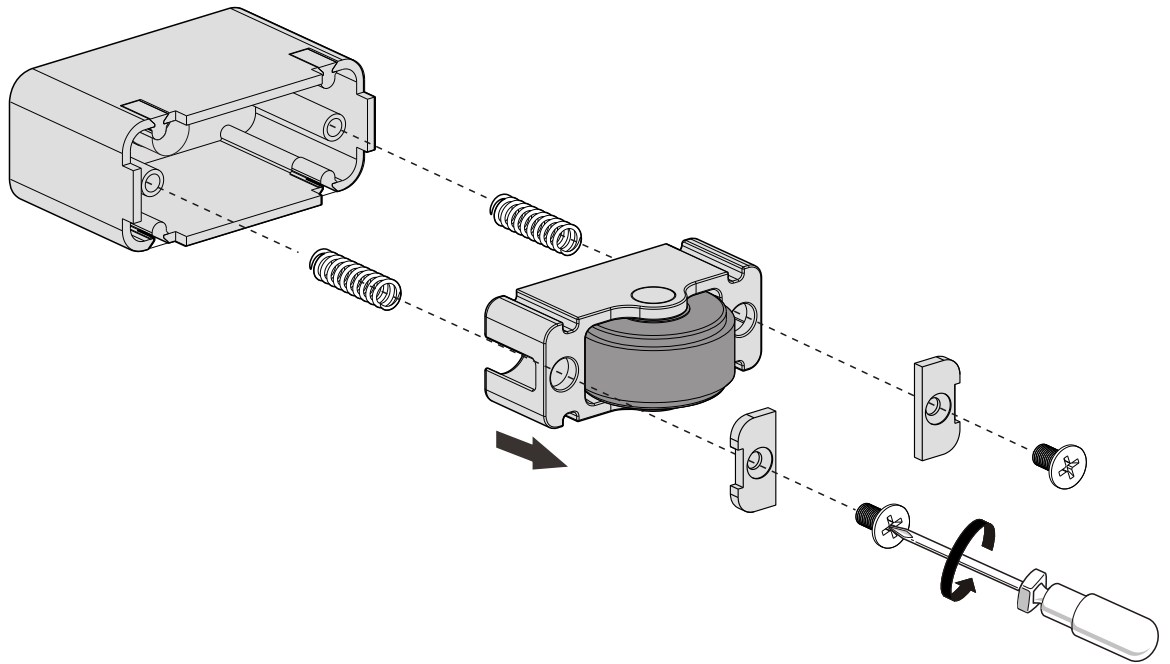

6 Fasten the bottom wheel body first.

E



(x2)



ST4.2x25 (x4)

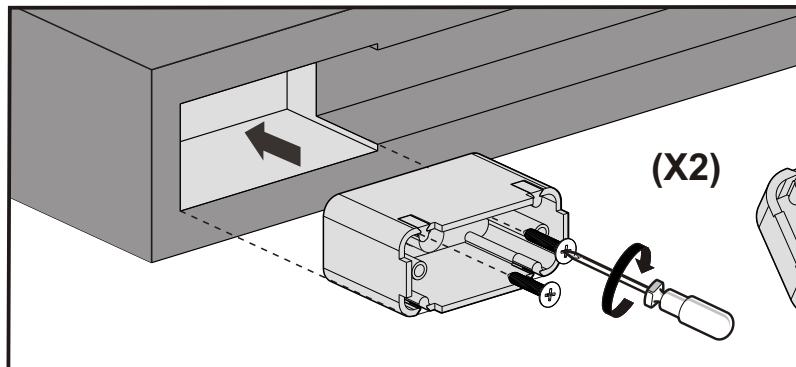
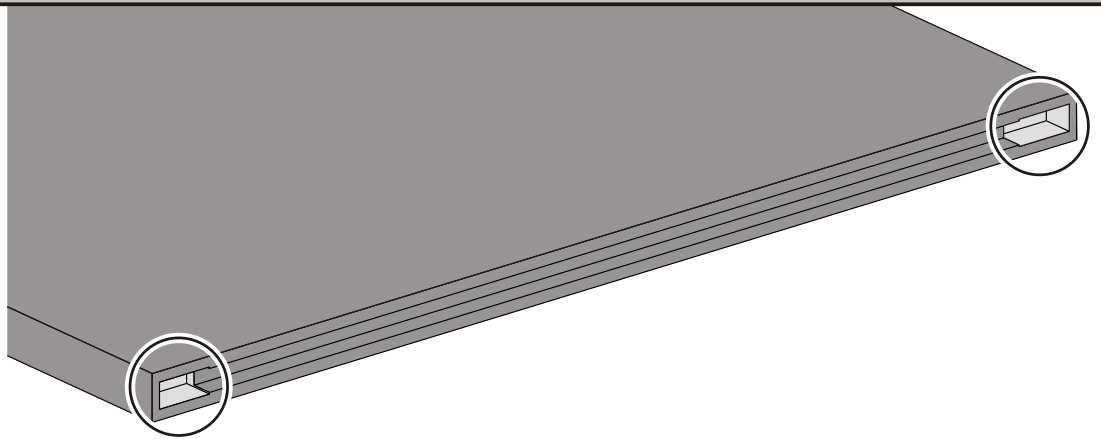

7 Put the wheel part back in the body.

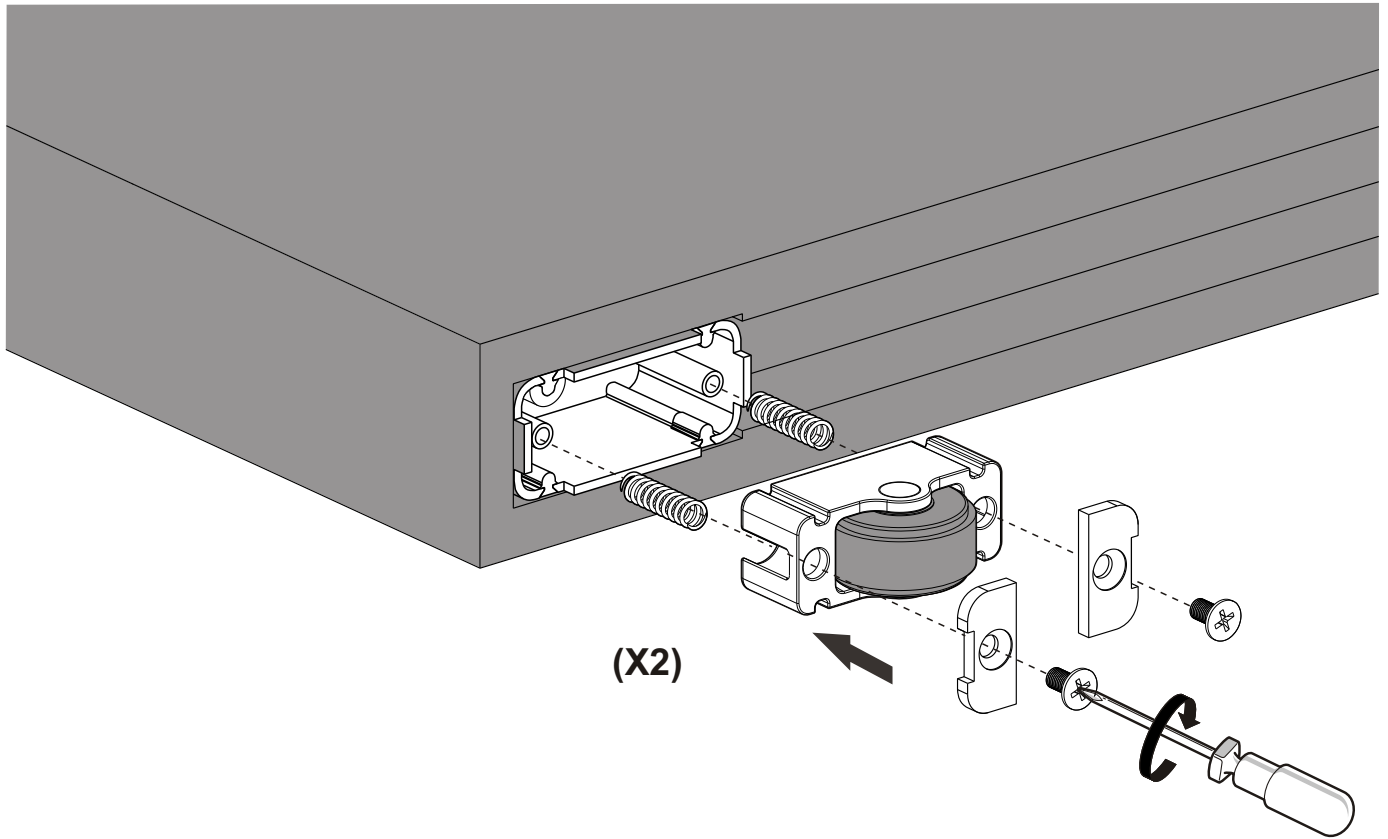

8 Cut bottom track to length (door width-130mm) and put the bottom track inside the bottom slot.

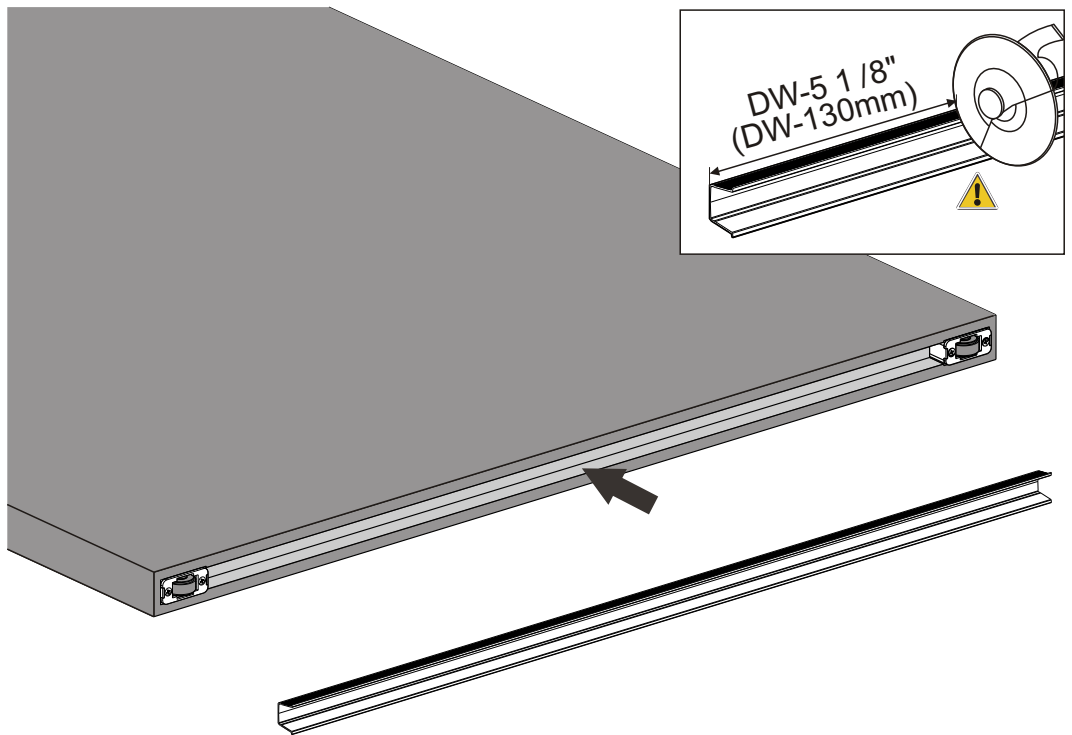
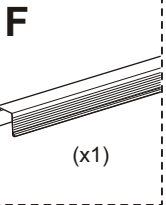

9a Remove anti-jump block of hanger first and mount hanger onto the wall.

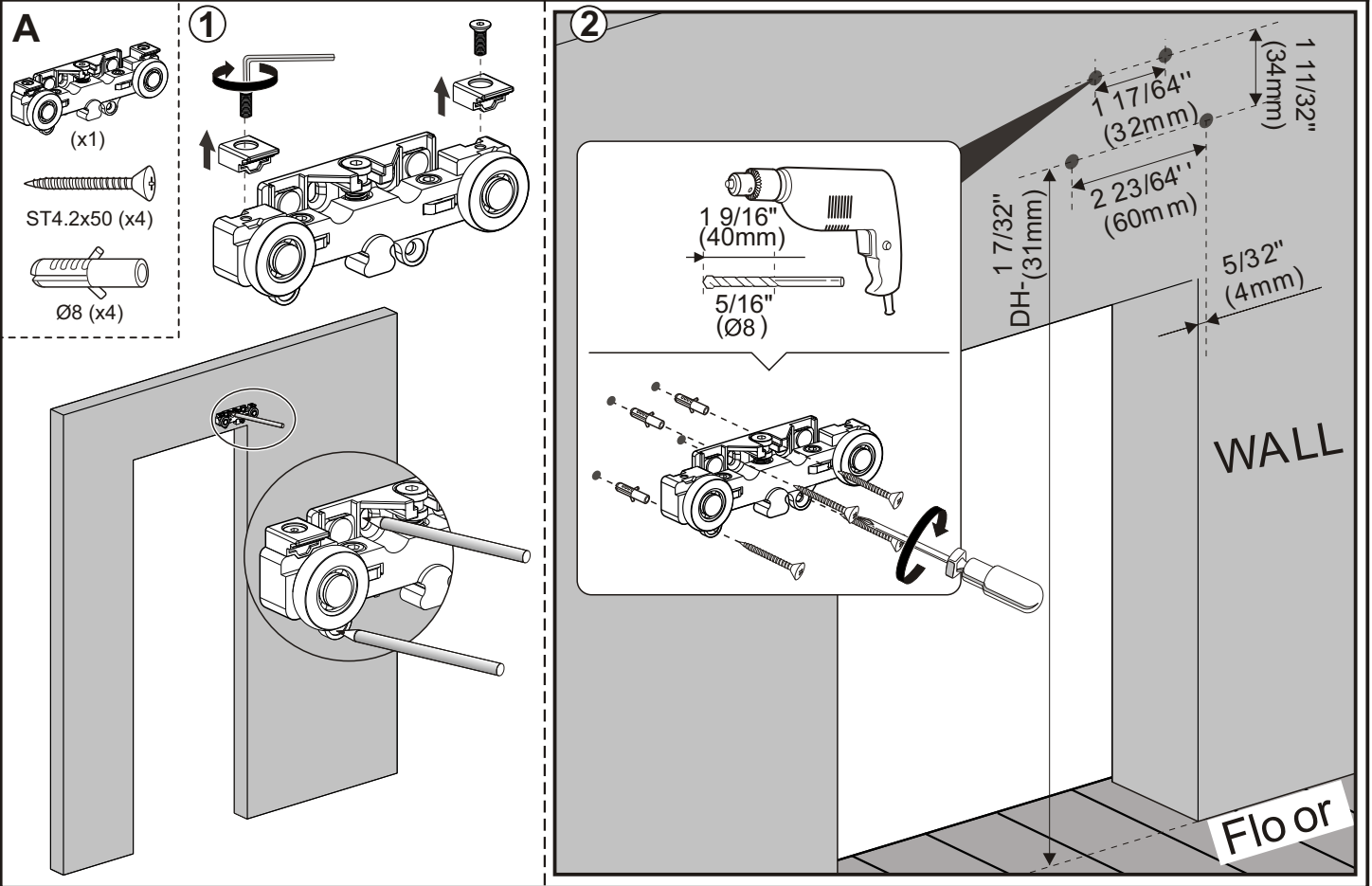

10a Mount floor guide.

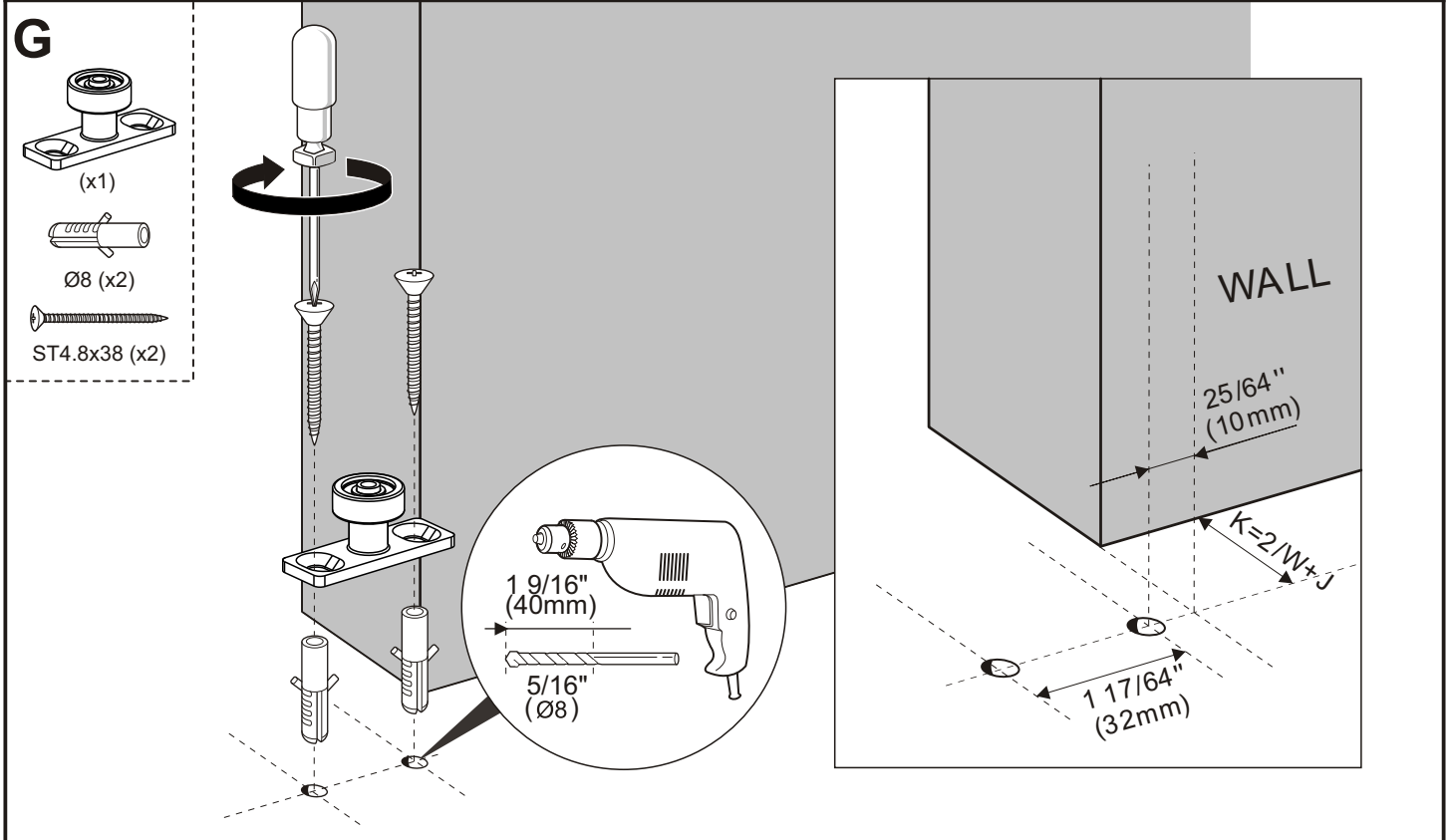

9b Remove anti-jump block of hanger first and mount hanger onto the wall.

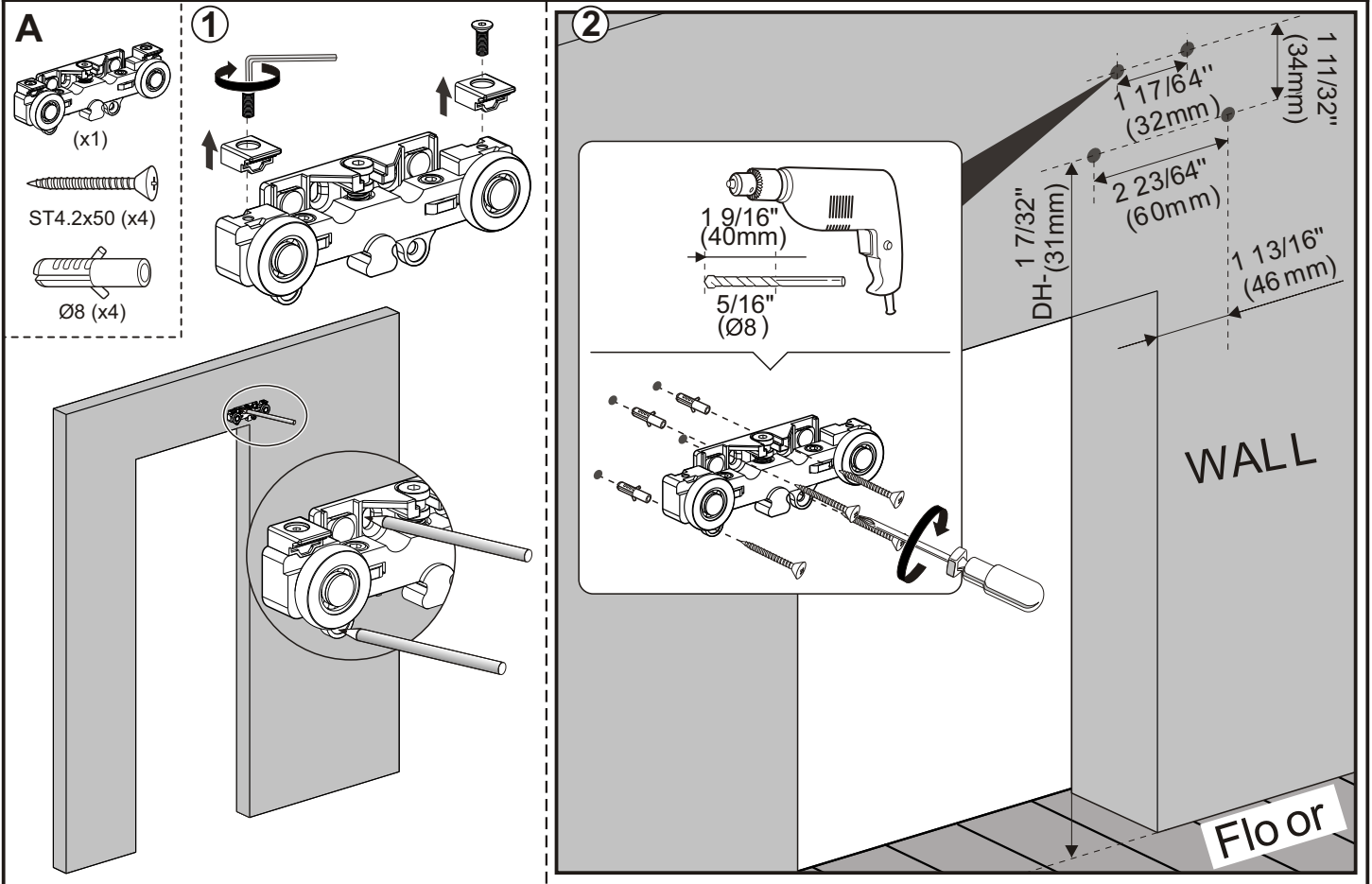

10b Mount floor guide.

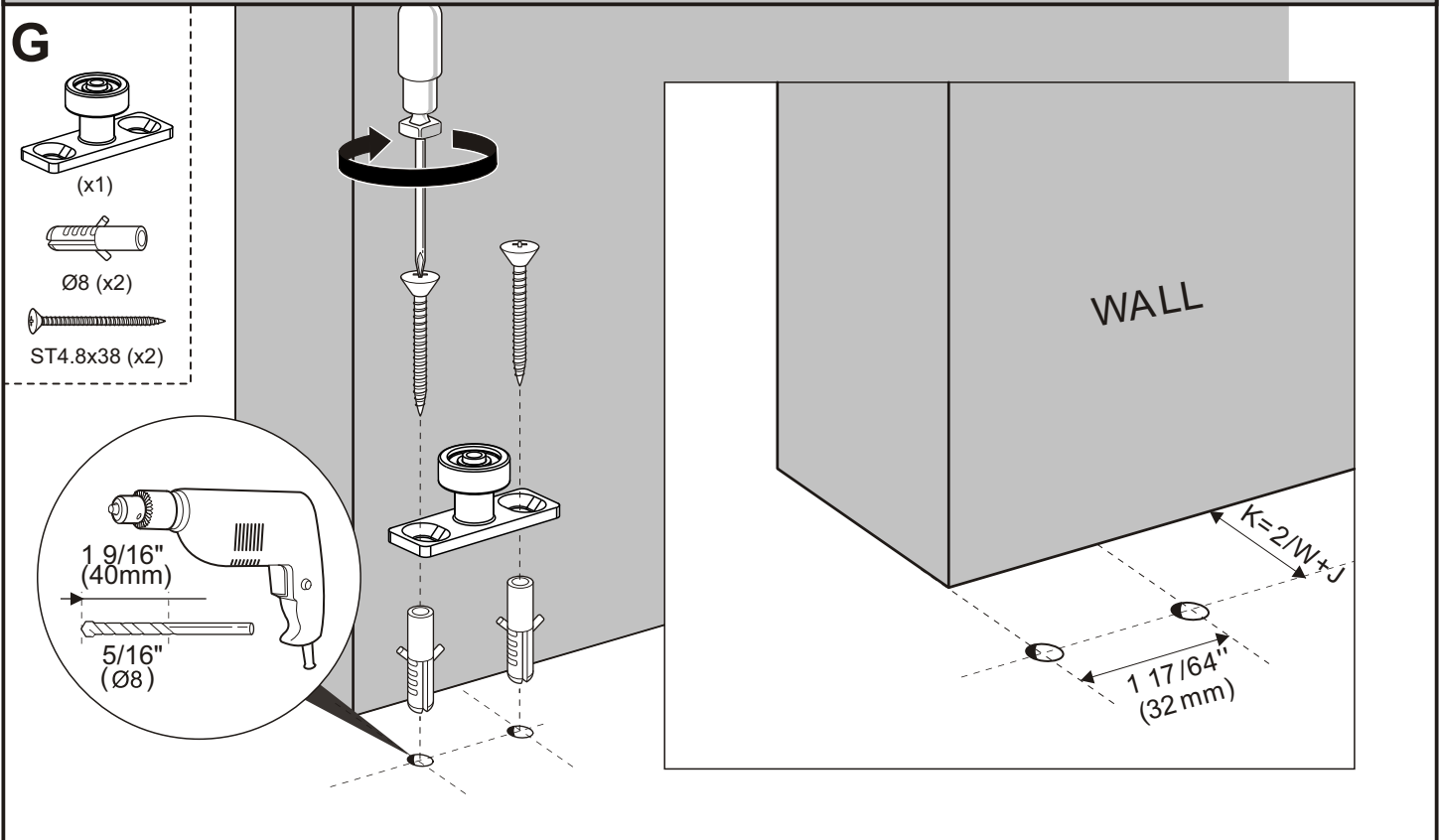

9c Remove anti-jump block of hanger first and mount hanger onto the wall.

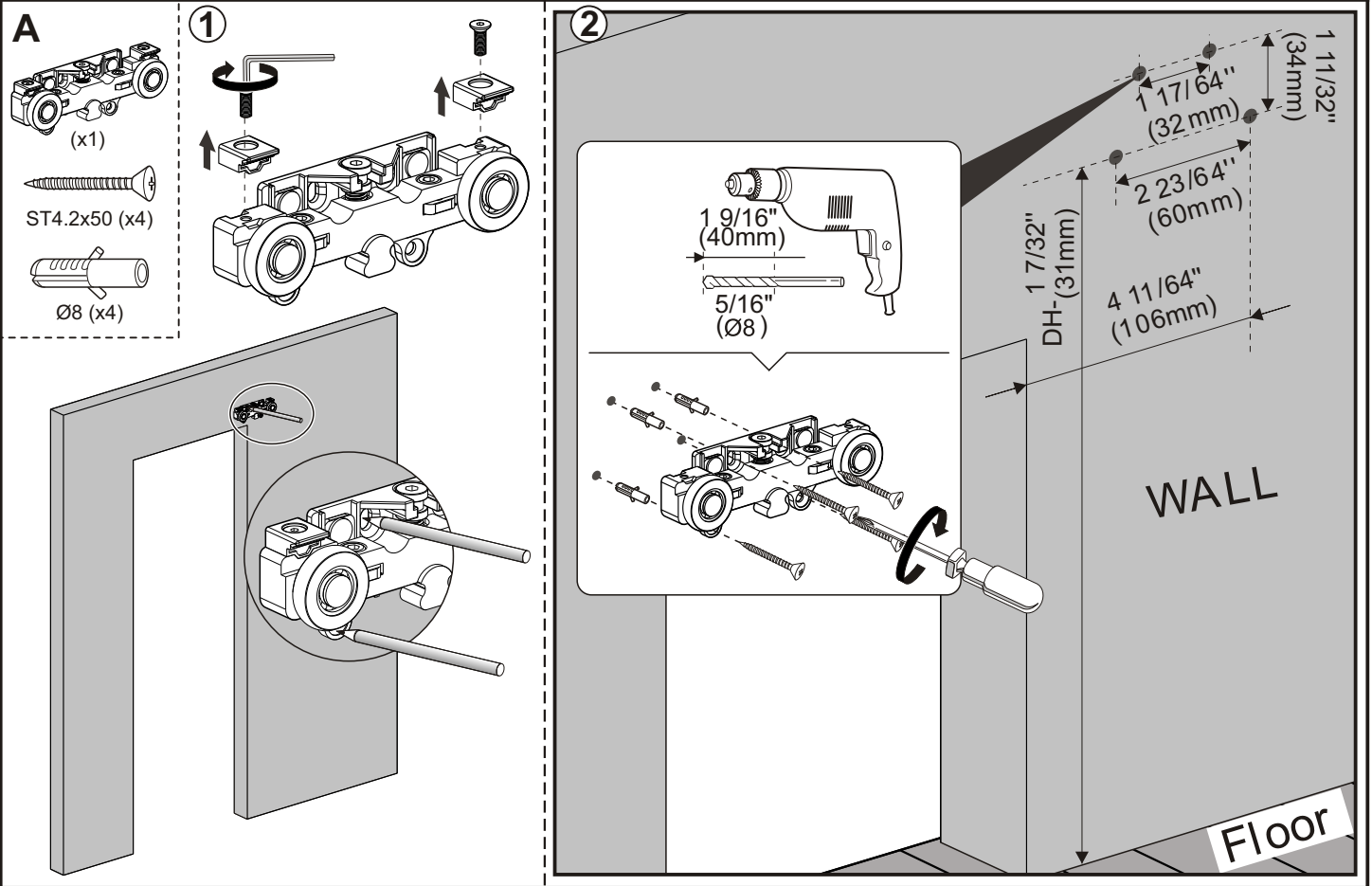

10c Mount floor guide.

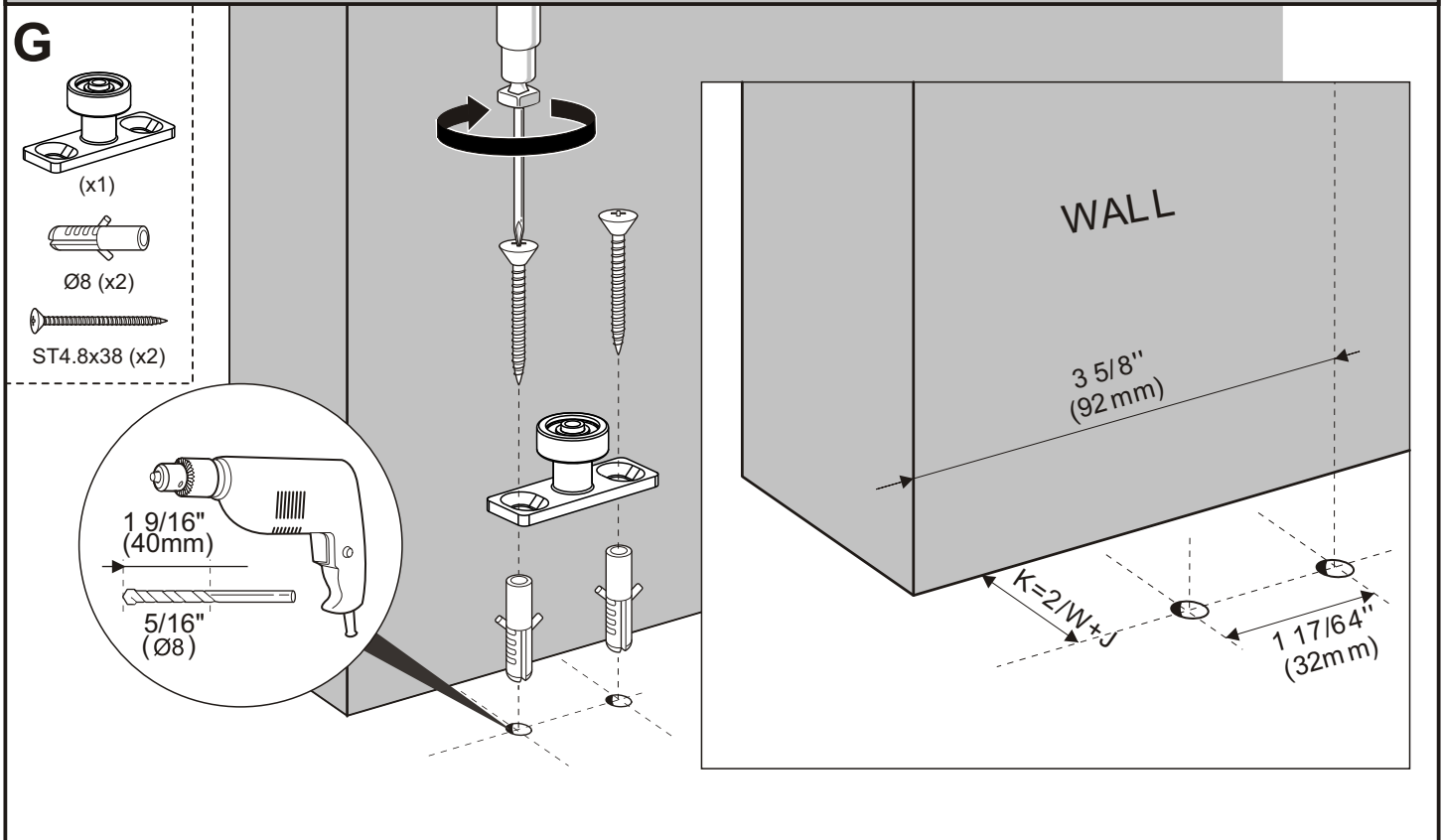

11 Put the floor guide inside the slot and hang door panel on the hanger. (hanger in the middle of top track)

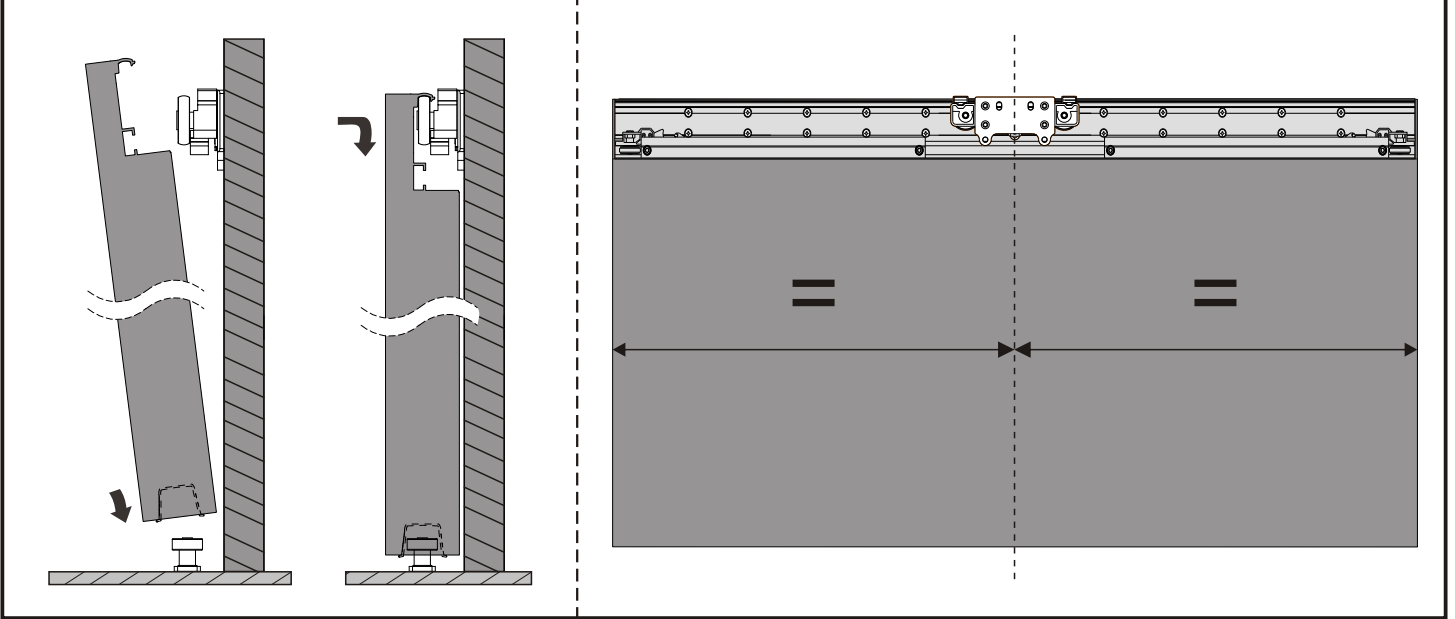

12 Rotate the screw to adjust the height of the wheel for fitting the rail completely.

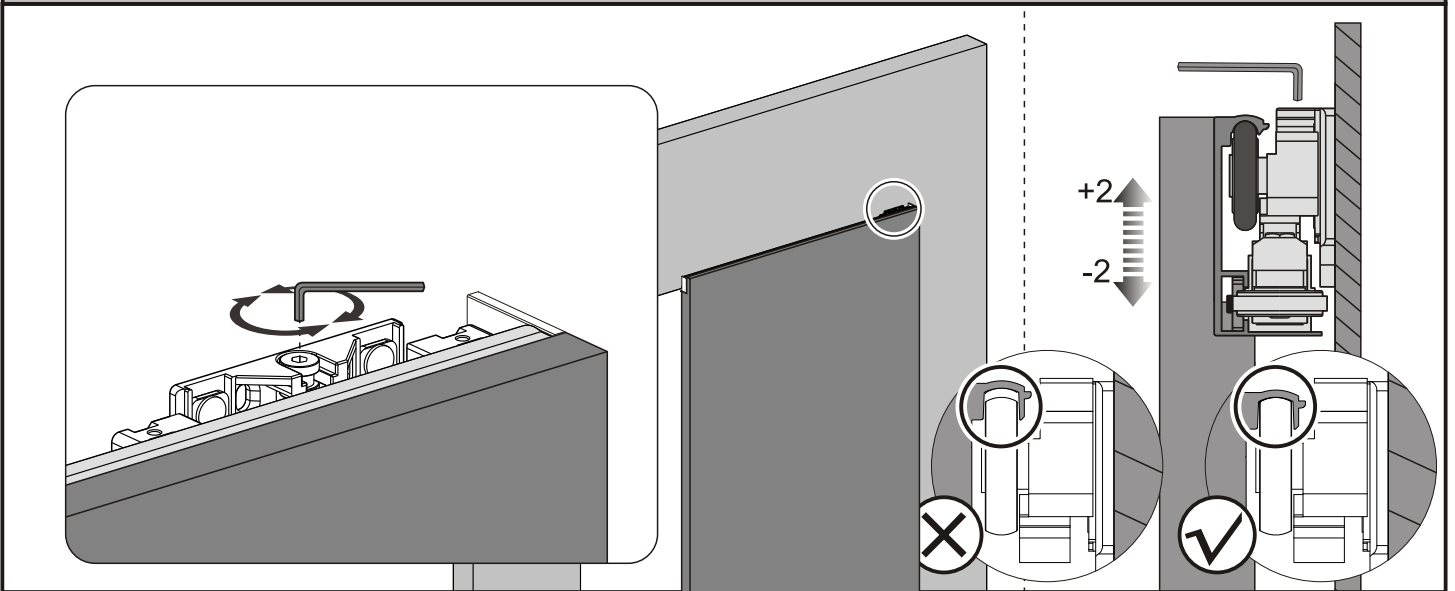

13 Tighten the anti-jump block screws.

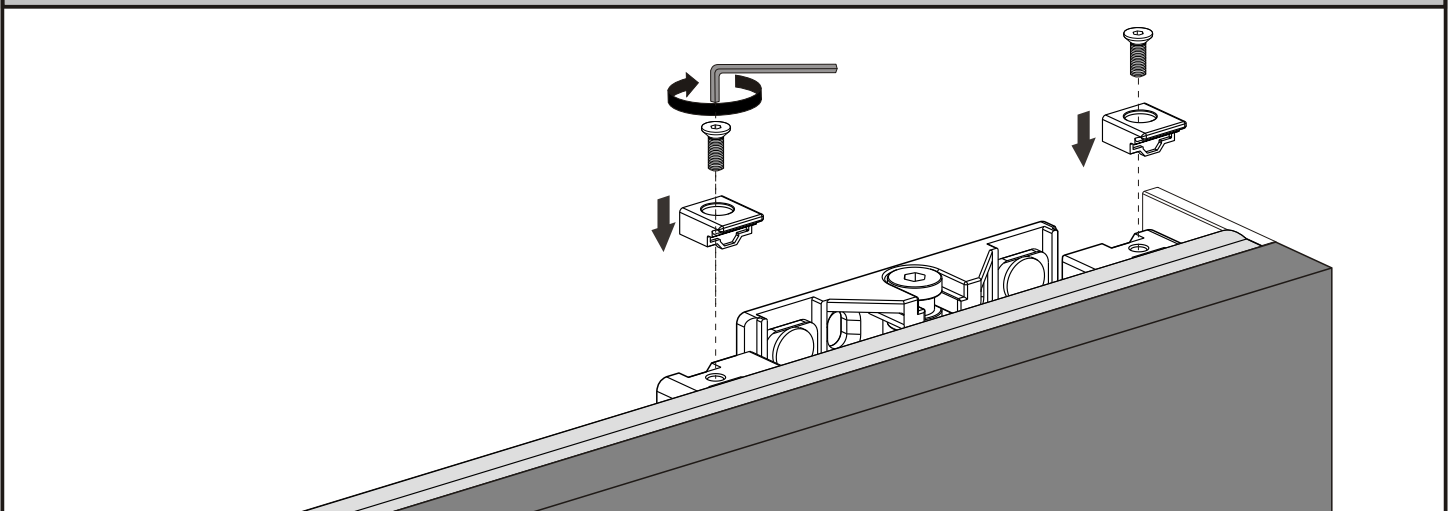

14 Move the door both left and right to ensure actuator is in between the fins of soft close.

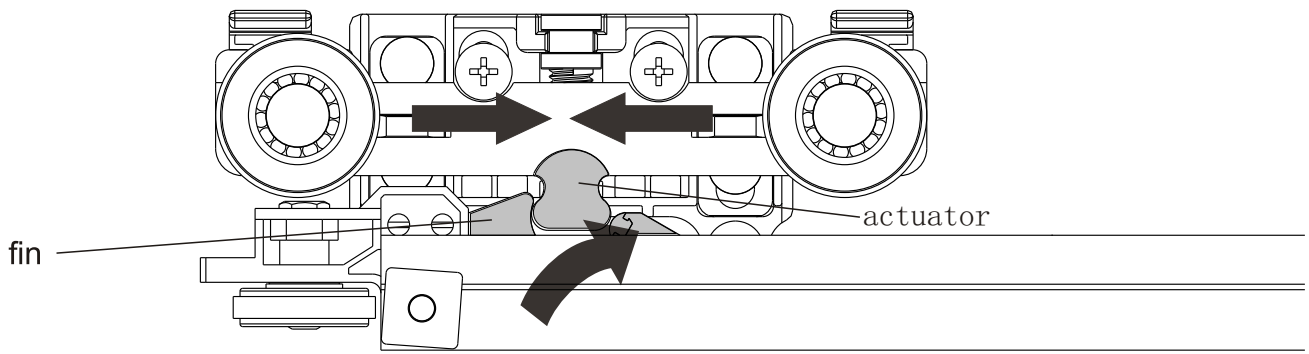

15 Adjust the door to ensure it is parallel with wall.

