

IMPORTANT

RETAIN FOR FUTURE REFERENCE

READ CAREFULLY

INSTRUCTION MANUAL



Note:

1. Do not use electric screwdriver.
2. Two people are required to assemble this item. Assemble the item on a flat, solid and even surface.
3. Make sure that all the necessary parts are in the carton before starting the assembly.
4. Please secure all parts and bolts loosely, only when the frame is complete should you fully tighten the screws.
5. If any instability occurs, loosen the screws, re-align the components as necessary and re-tighten the screws evenly.
6. This item is not a climbing frame or toy.
7. Danger of suffocation. Keep out of reach of children.

Contact Us!

Contact our friendly customer service department for help first.
Replacements for missing or damaged parts will be shipped ASAP!

Contact Us!

Dear Customer, Thanks for buying from us.

If you have questions or quality problems during the installation and use, please kindly contact us through message.

We will reply you within 24 hours and solve your problem as soon as we can.

Returns Policy!











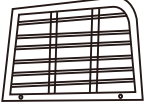

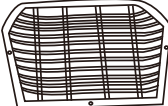

We offer a returns policy equivalent.

Ensure you enclose the correct and complete item when making a return. The correct item must be returned to receive a refund. It can take up to 15 days for an item to reach us once you return it. Once the item is received at our fulfillment center, it takes 2 business days for the refund to be processed and 3-5 business days for the refund amount to show up in your account.

Warranty!

The product is guaranteed to be free from defects in workmanship and parts for a period of 12months from the date of purchase. Defects that occur within this warranty period, under normal use and care, will be repaired, replaced or refunded at our discretion.

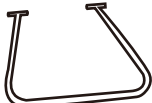
COMPONENT LIST - String-4pcs set

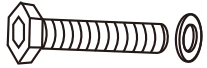
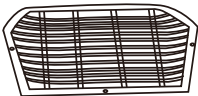
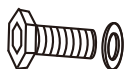
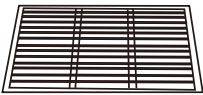
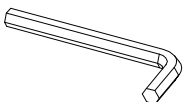
Part	Reference Image/Description	Qty	Part	Reference Image/Description	Qty
A	 Left arm	3	J	 (2cm longer than the rear bar) Sofa front support bar	1
B	 Right arm	3	J-1	 Sofa rear support bar	1
C	 Back	2		 Chair seat cushion	2
D	 Seat	2		 Sofa seat cushion	1
E	 Chair left leg	3	K	 Table top frame	1
E-1	 Chair right leg	3	L	 Table glass	1
F	 (2cm longer than the rear bar) Chair front support bar	2	M	 Table leg	2
F-1	 Chair rear support bar	2	S	 M6X35mm Bolt	23
G	 Sofa back	1	S-1	 M6X15mm Bolt	56
H	 Sofa seat	1	W	 M4 Allen Key	1

*The quantities above are the correct amount to complete the assembly. In some case more fittings may be supplied than required.

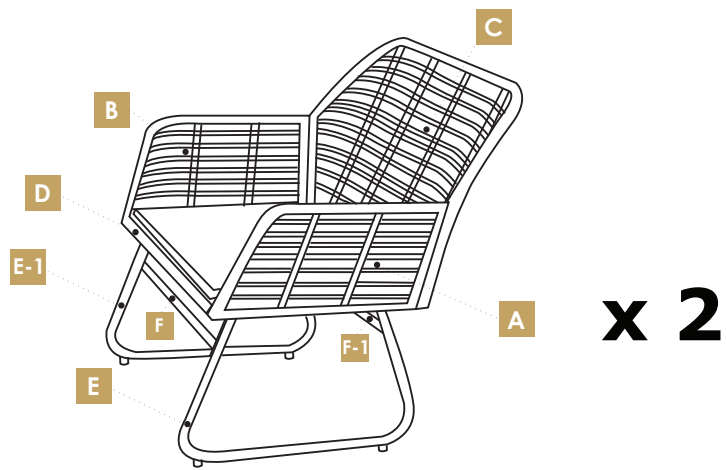

1

C

D

S x1
(M6*35mm)

50%

50% 100%

2

B

A

S x2
(M6*35mm)

50%

50% 100%

3

S-1 x8 (M6*15mm)

S x4
(M6*35mm)

E

E-1

50%

50% 100%

4

S-1 x8 (M6*15mm)

F

F-1

This is very important!

This side up! This side down!

100%

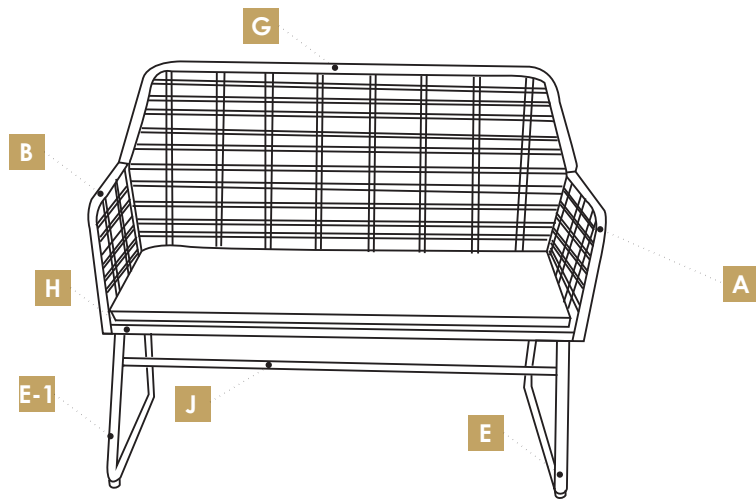

1

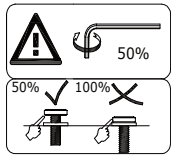
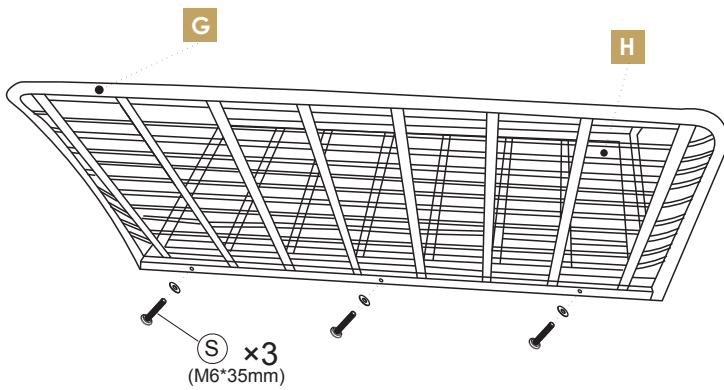

2

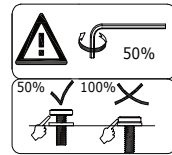
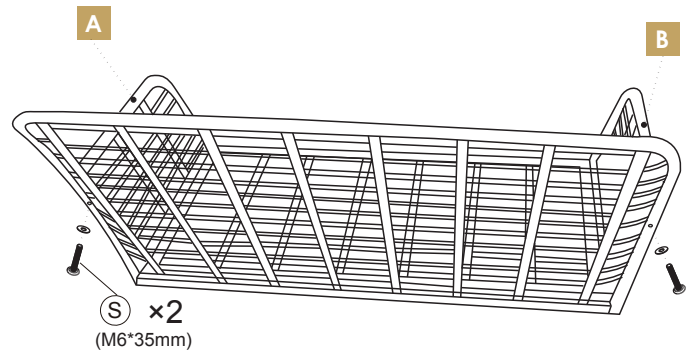

3

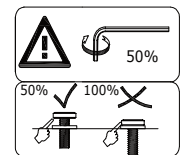
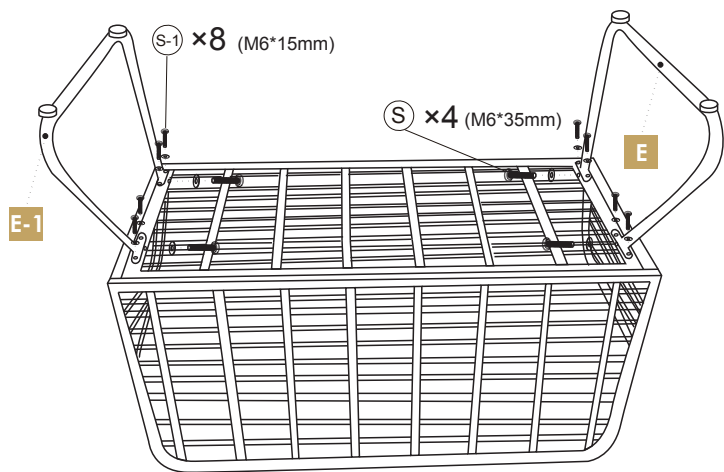

4

This is very important!

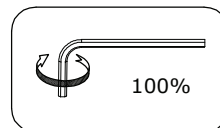
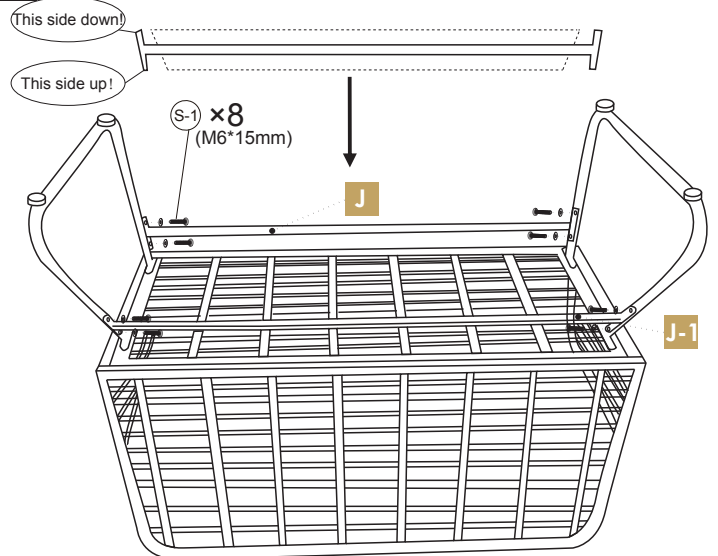

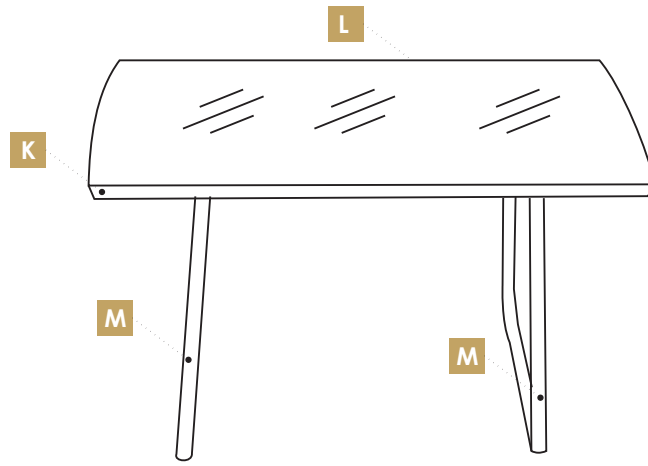

1

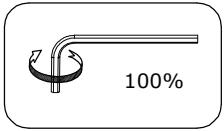
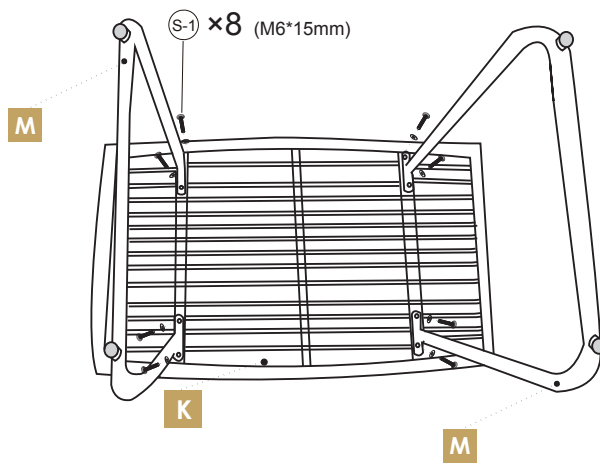

2

