

# ASSEMBLY INSTRUCTIONS

## BED - KING

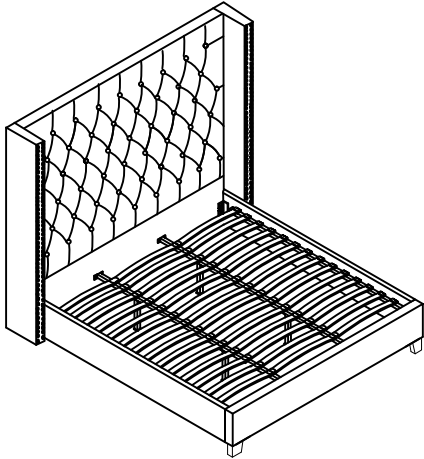

### + Parts Included

- ① Head Board (1pc)      ② Foot Board (1pc)      ③ Side Rails (2pcs)

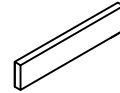
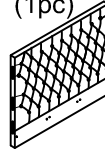

- ④ Double Plastic cap (30pcs)      ⑤ Center Support Bar (2pcs)      ⑥ Support Legs (4pcs)

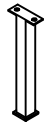
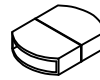

- ⑦ Slats (45pcs)      ⑧ Single Plastic cap (30pcs)      ⑨ Legs (4pcs)

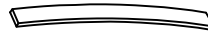

\*Slats come packed in the bottom of headboard carton.

- ⑩ Left wing (1pc)      ⑪ Right wing (1pc)



+ Do Not Use Power Tools



+ Suggested Adults

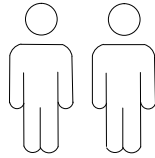

#### NOTE:

- 1 Read instructions cover to cover.
- 2 Save all packaging until assembly is completed.

### 1 IMPORTANT SAFETY INFORMATION

Do not assemble the product if any of the following parts arrived damaged:

- Part #③ -Side Rails
- Part #⑤ -Center Support Bar
- Part #⑥ -Support Legs
- Part #⑦ -Slats

### 2 IMPORTANT ASSEMBLY INFORMATION

Assembly Step ③ Ensure the side rail bracket is fully hooked onto bolt **A** loosely threaded with both washers on the **OUTSIDE** of the bracket first, then proceed to fully tightening all 4 corners.

Assembly Step ⑥ When installing slats, ensure that the curve is facing upwards. (↗) (↘)  
\*Slats come packed in the bottom of headboard carton.

### + Hardware Included

- A Bolt M8\*30mm (24pcs)      B Bolt M8\*75mm (6pcs)



- D Spring Washer (8pcs)      E Flat Washer  $\phi 20$  (28pcs)      F M8 Allen Key (1pc)



- G Flat Washer  $\phi 22$  (6pcs)

- I Nut M8\*13mm (8pcs)



- J Spanner (1pc)



# ASSEMBLY INSTRUCTIONS

## BED - KING

