

EN_ IMPORTANT, RETAIN FOR FUTURE REFERENCE: READ CAREFULLY.

**FR_ IMPORTANT: A LIRE ATTENTIVEMENT ET A CONSERVER POUR VOUS Y REFRERER
ULTERIEUREMENT**

ES_ IMPORTANTE, LEA DETENIDAMENTE Y GUARDE PARA FUTURAS REFERENCIAS.

PT_ IMPORTANTE, GARDE PARA FUTURA REFERÊNCIA, LEIA ATENTAMENTE.

DE_ WICHTIG! SORGFÄLTIG LESEN UND FÜR SPÄTER NACHSCHLAGEN AUFBEWAHREN.

**IT_ IMPORTANTE, LEGGERE E CONSERVARE QUESTO MANUALE D'ISTRUZIONE PER UN USO
FUTURO.**

HARDWARE

A x4
+1(spare)

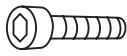

B x4
+1(spare)



C x1



D x1



M6x8mm

PARTS

1 x1

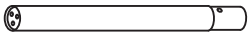

2 x1

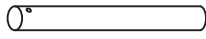

3 x1

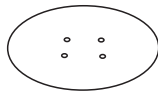

4 x1



5 x1

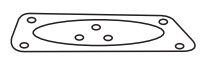

1 x1

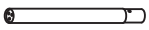

2 x1

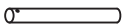

C x1



D x1



01

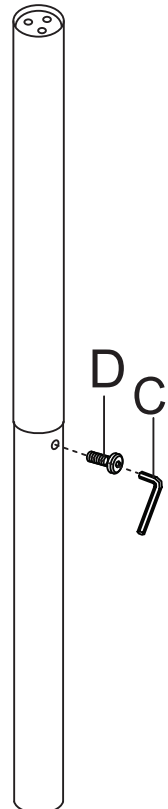
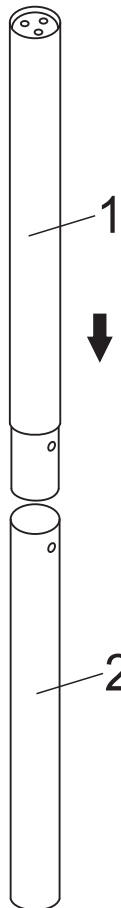
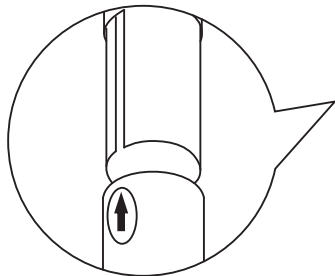

4 x1



A x3



C x1

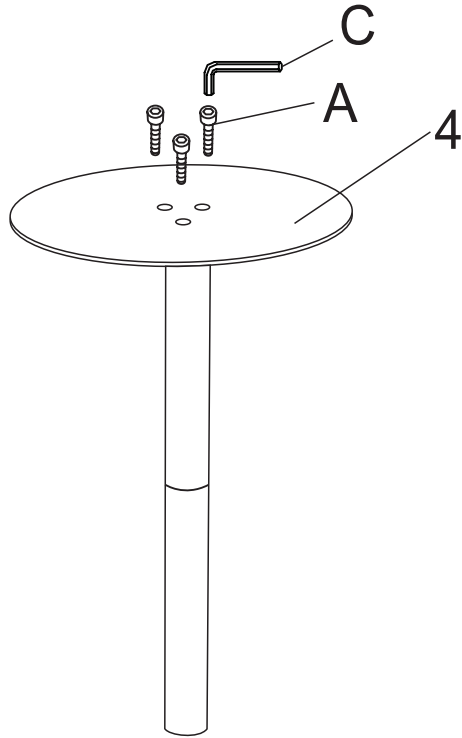

5 x1

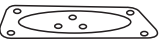

A x1



C x1

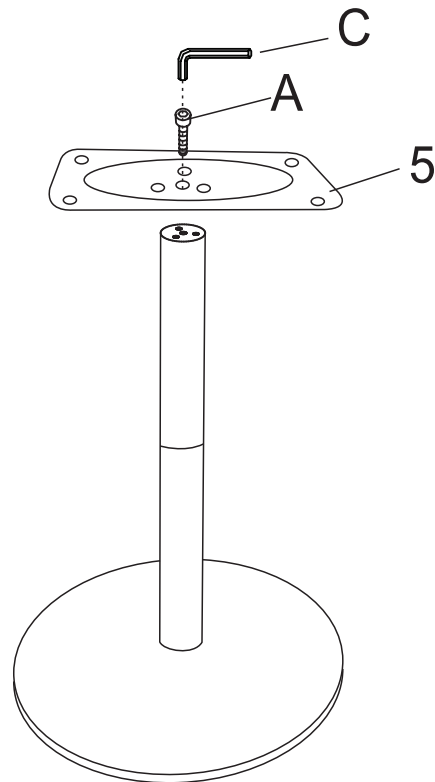

3 x1

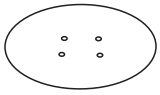

B x4



C x1

