



Outdoor
Living Today

ASSEMBLY MANUAL

8x8 Garden in a Box

Greenhouse Cover

Stock Code:

RB88GHO

Version #2.8

Nov 6, 2025



CONTACT

ADDRESS

9393 287th Street,
Maple Ridge, British Columbia,
Canada V2W 1L1

PHONE & FAX

Toll Free: 1-888-658-1658

Fax:

ONLINE

Email: olmsupport@outdoorlivingtoday.com

Web: www.outdoorlivingtoday.com

What You Need to Know

It is the sole responsibility of the customer to check with your local municipal or county by-laws before ordering this product to confirm it complies with building codes in your area.

If the product is elevated, any structural and building code requirements are solely the customer's responsibility, and should be abided by.

Have a regular maintenance plan to ensure screws, doors, parts are tightly affixed.

All structures purchased from Outdoor Living Today are covered for a period of one year for defects in manufacturing and workmanship. Costs incurred for customer installations are not included.

Failure to use supplied parts included in this kit could result in poor product performance and may void your warranty. Please contact Outdoor Living Today's Customer Toll Free Line if you plan to deviate from our written instructions.

Safety Points and Other Considerations

In colder climates, please remove your Garden in a Box Plastic Cover during the winter months and store in included bag in a dry warm location.

Do not leave cover on during any large snow storms or extreme weather phenomenon such as hurricanes, tornadoes or heavy wind storms.











Cover can easily be taken off in minutes if such weather patterns are forecast in your area. We recommend once a year in the early spring to check that all fasteners are snug and to tighten if loose. Plastic cover can be cleaned with a mild soap and a cloth.

Warranty

In the event of a missing or broken piece, please contact Outdoor Living Today **Customer Support at olmsupport@outdoorlivingtoday.com within 30 days of the delivery of your purchase.** It is our commitment to you to courier replacement parts, free of charge, **within 10 business days of this notification.** Replacement parts will not be provided free of charge after

Customer agrees to hold Outdoor Living Today and any Authorized Dealers free of any liability for improper installation, maintenance and repair.

Thank you for purchasing our 8x8 Garden in a Box with Greenhouse Cover.
Please take the time to identify all the parts prior to assembly.

Part 1		x 10
Part 2		x 5
Part 3		x 10
Part 4		x 5
Part 5		x 5
Part 6		x 8
Part 7		x 2
Part 8		x 2
Part 9		x 3
Part 10		x 2
Part 11		x 3

Hardware & Miscellaneous

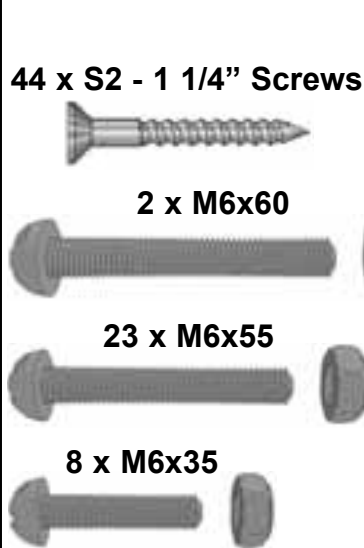

2 x Protective Stripping Rolls (30ft each)

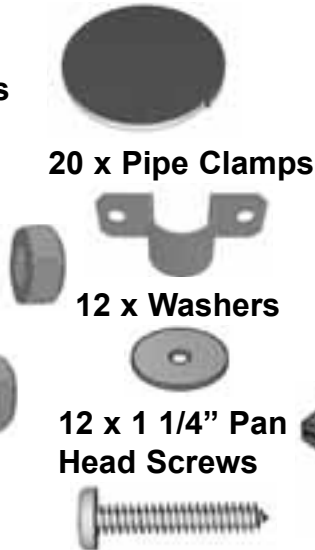

1 x BR1 - Square Drive Bit



Greenhouse Cover

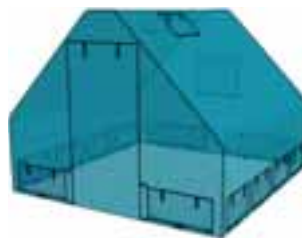

Storage Bag



Tools Required

(Not Provided)



Exploded View

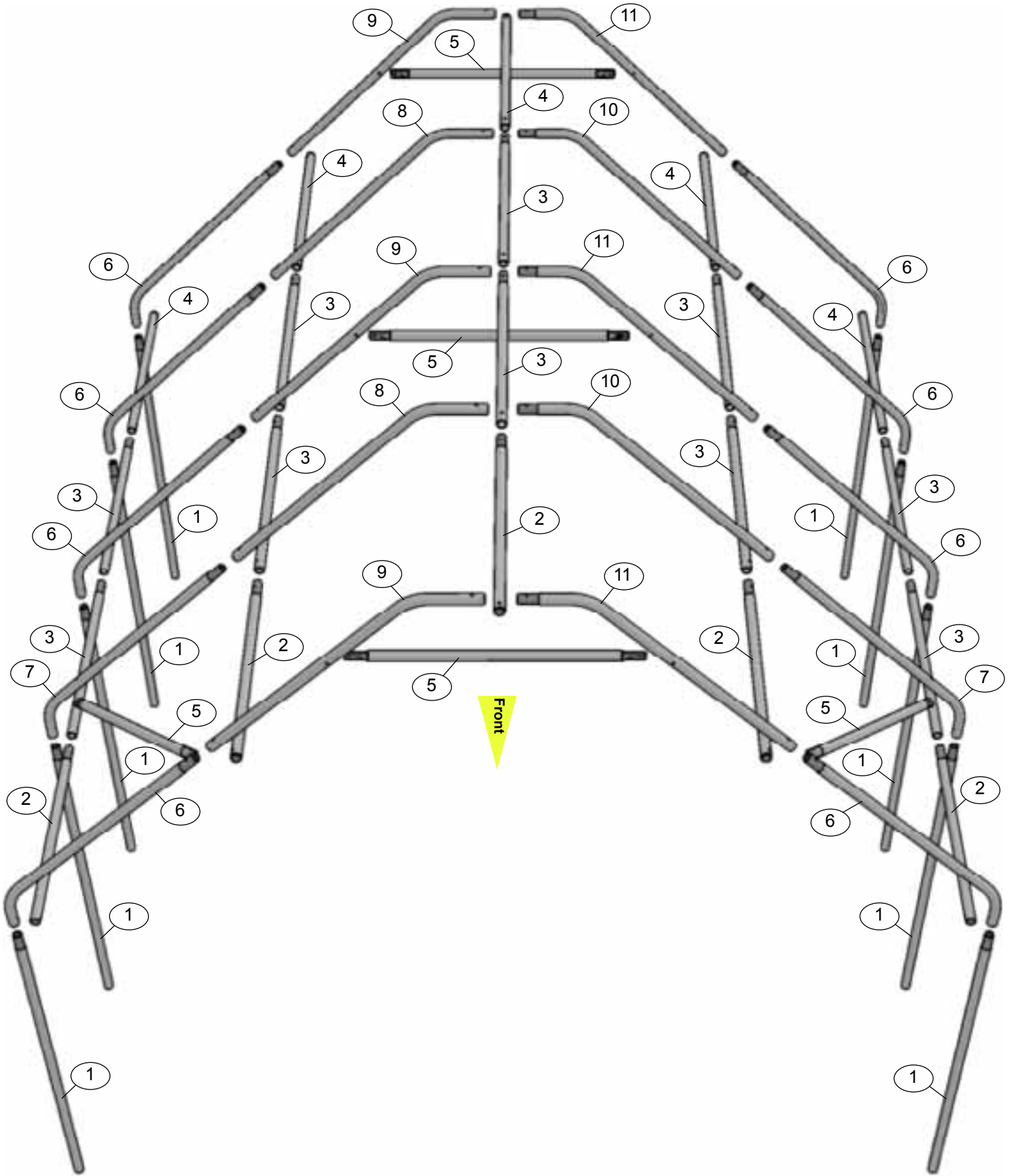

Step 1	Parts & Hardware	
	1 x Part 4	1 x Part 11
1 x Part 9	1 x M6x55	

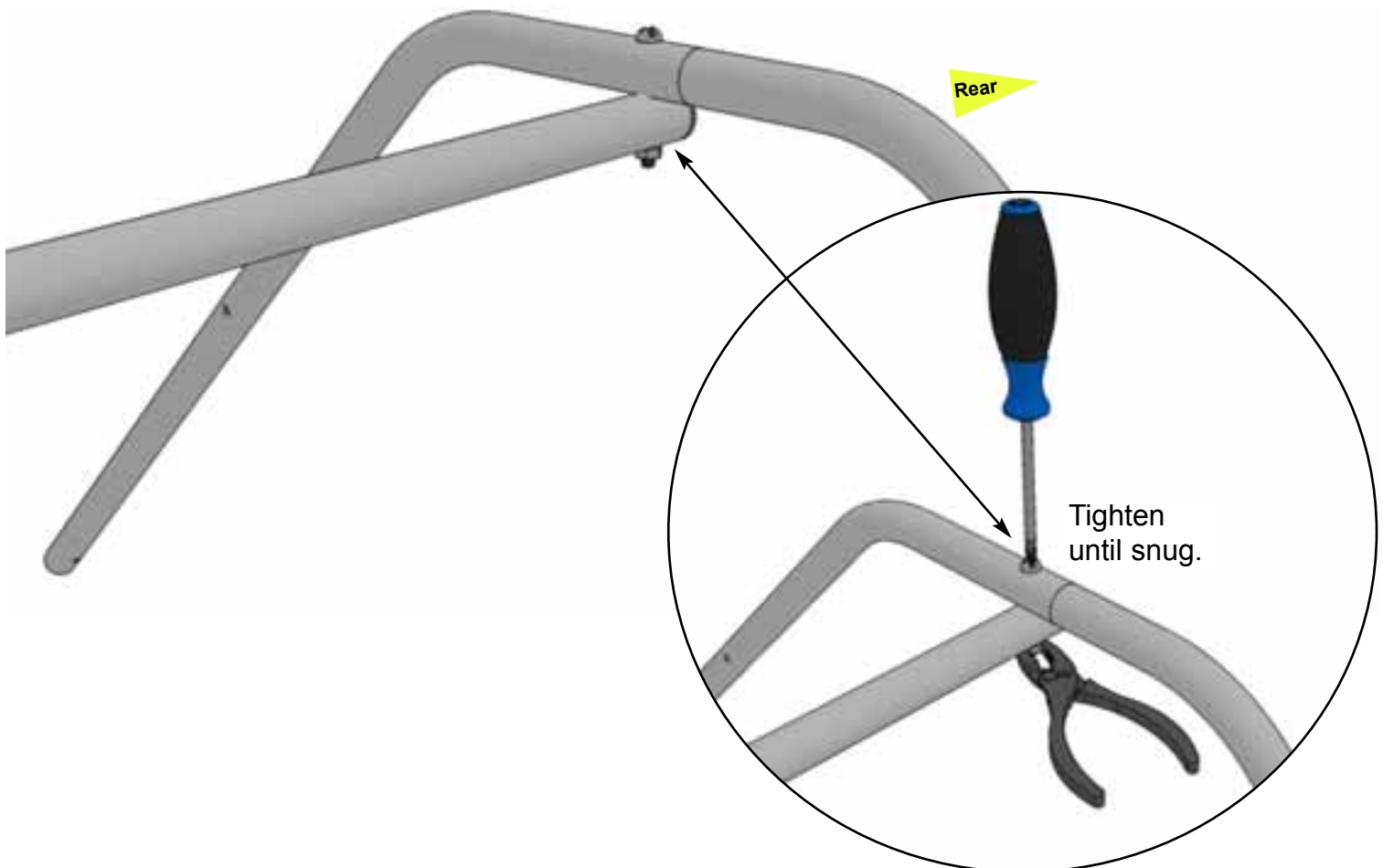
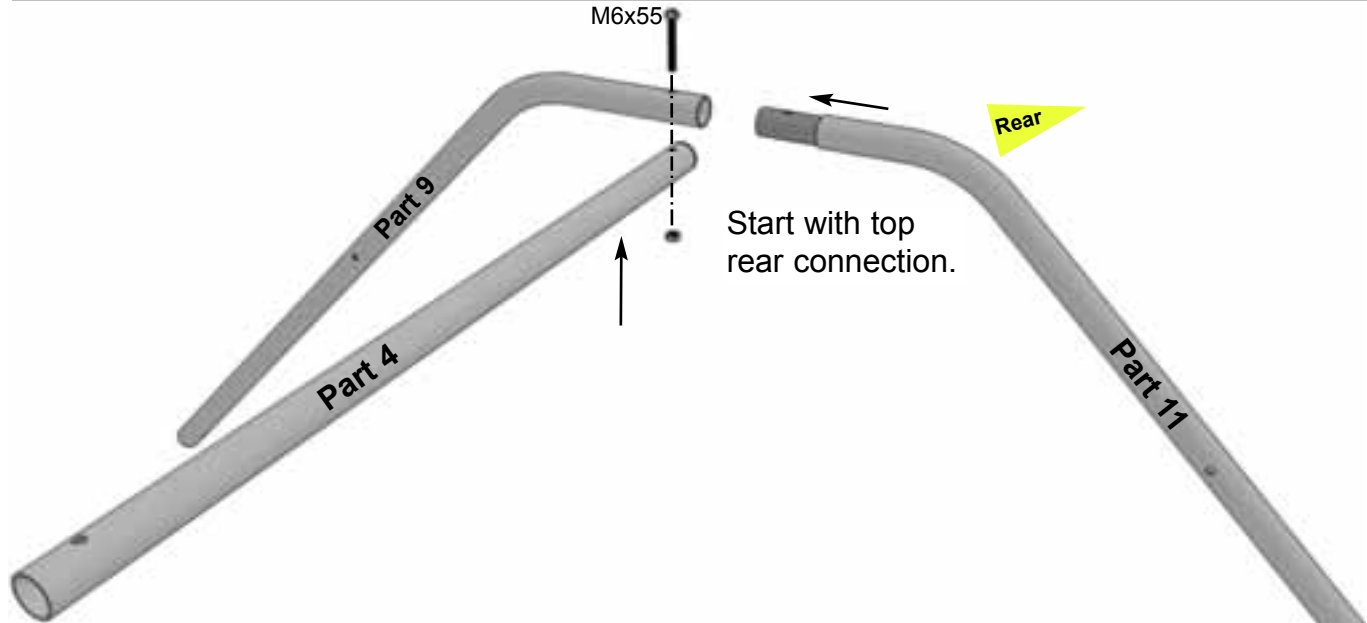

Step

Parts & Hardware

2

1 x Part 5



2 x M6x35

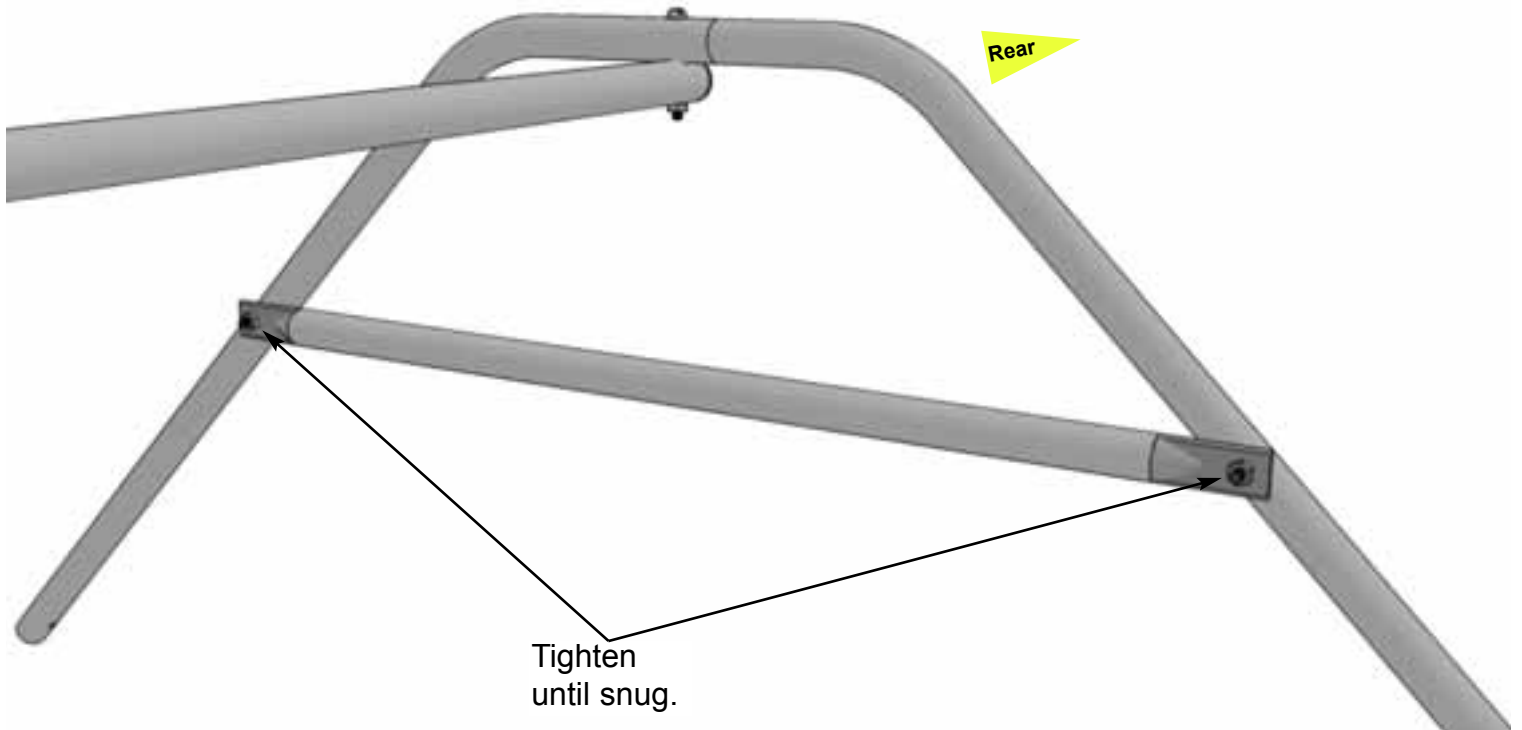
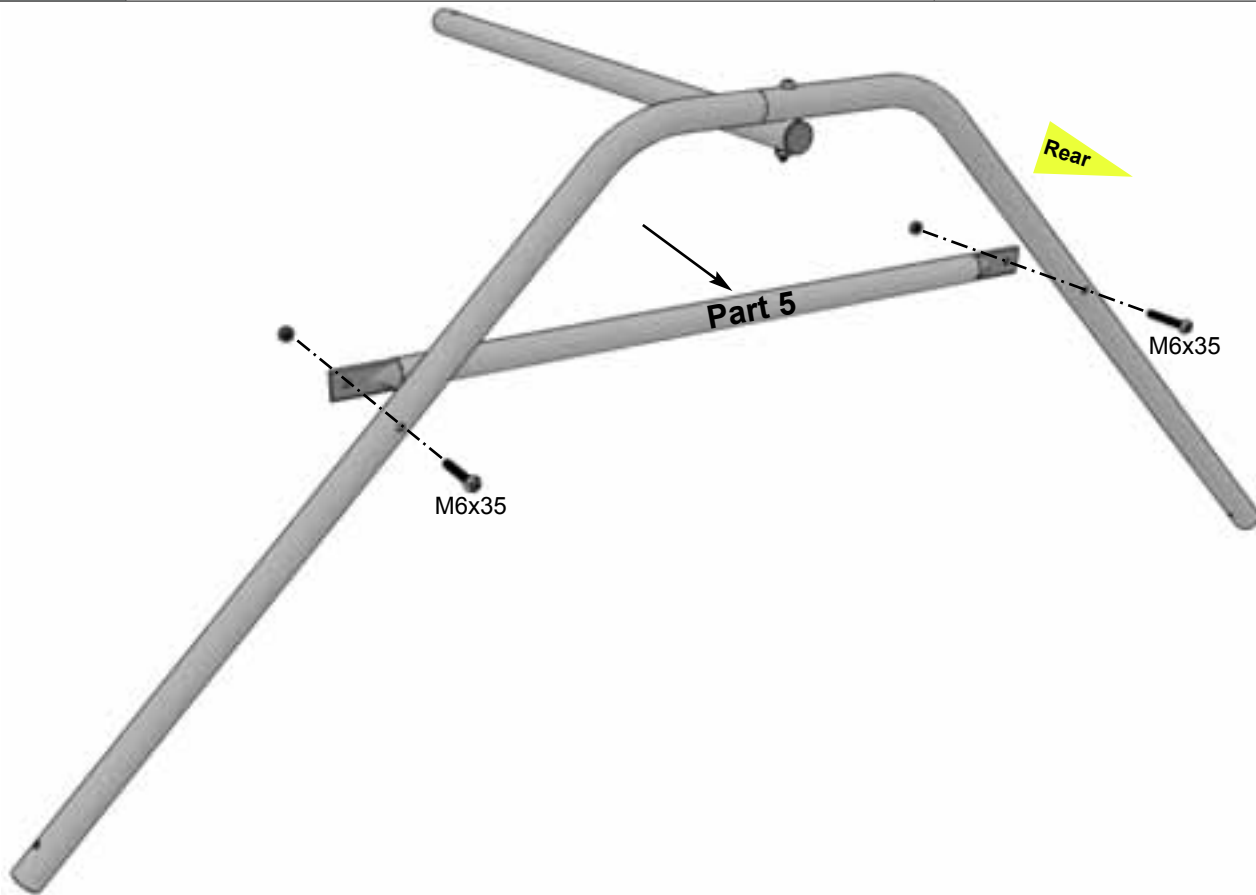

Step	Parts & Hardware	
3	1 x Part 3	1 x Part 10
	1 x Part 8	1 x M6x55

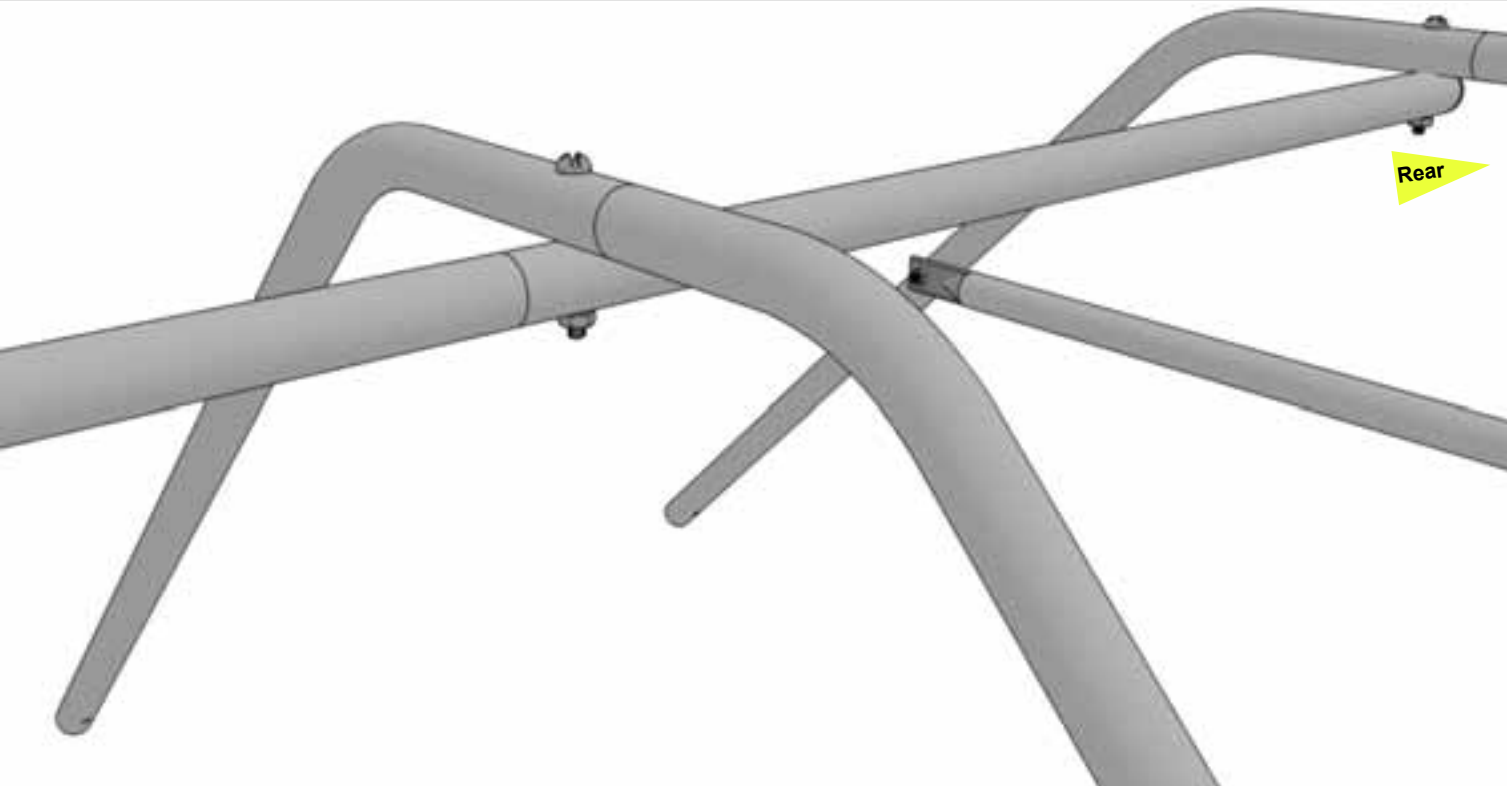
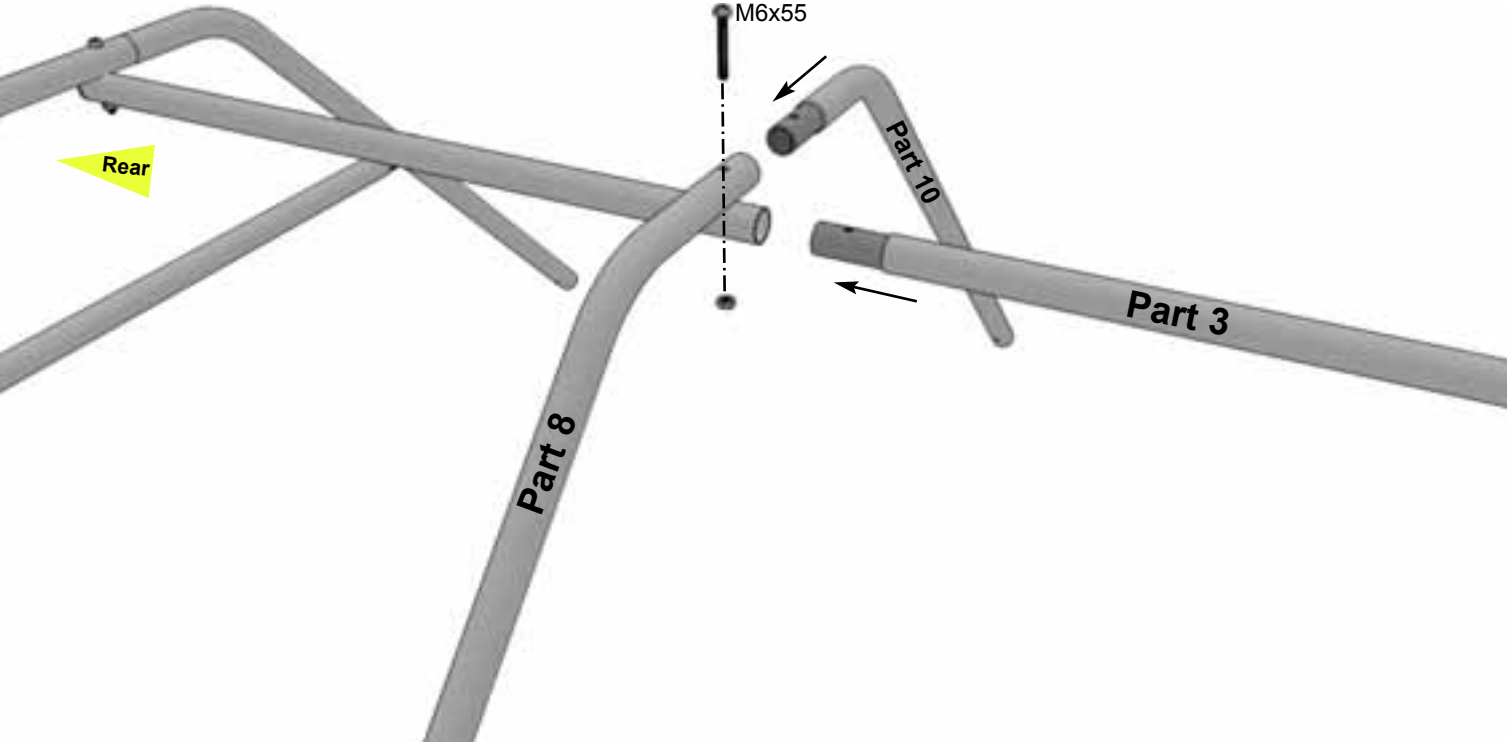

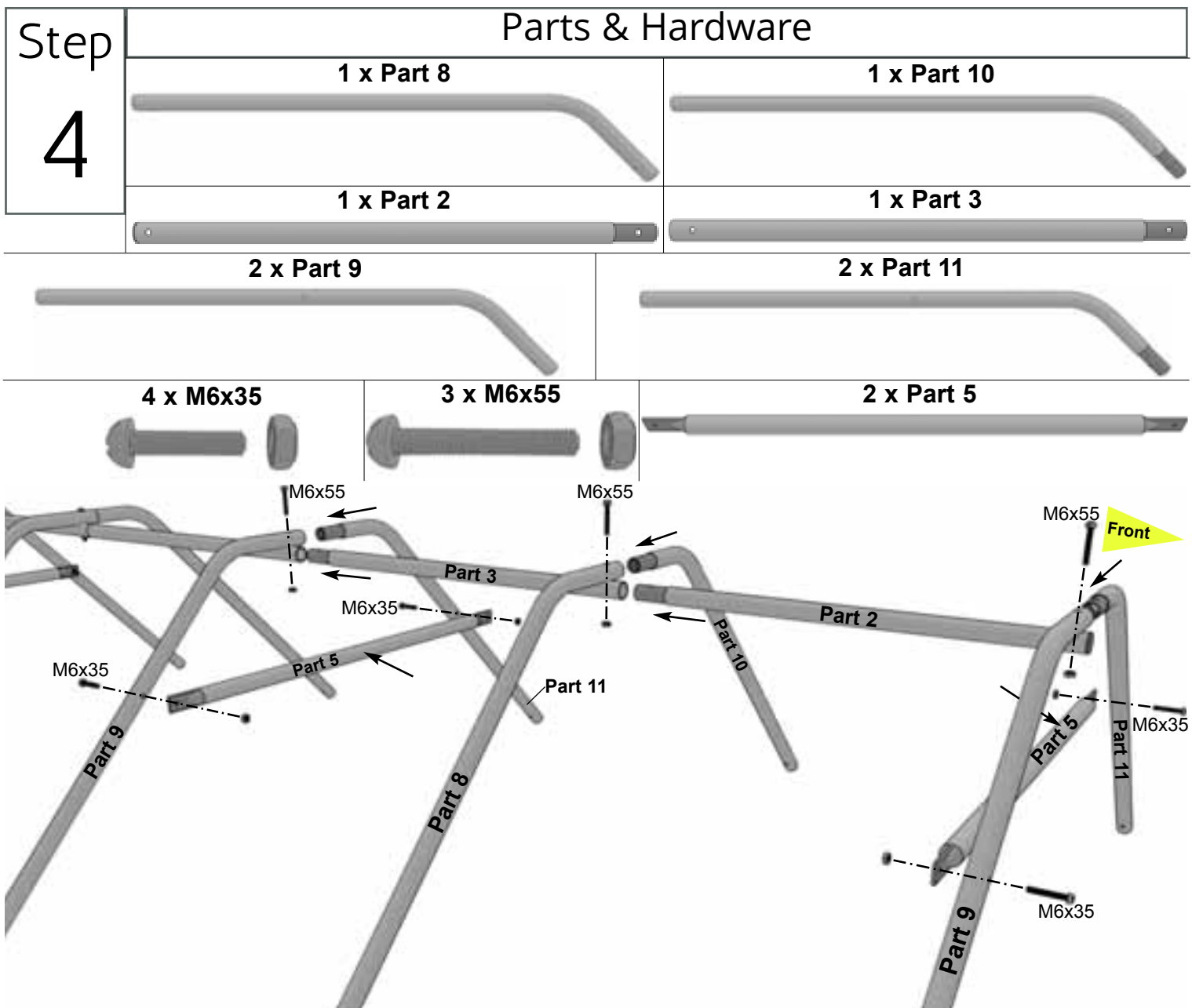

Step

Parts & Hardware

5

1 x Part 7

4 x Part 6

1 x Part 4

1 x Part 3

1 x Part 2

2 x Part 5

1 x M6x35

4 x M6x55

1 x M6x60

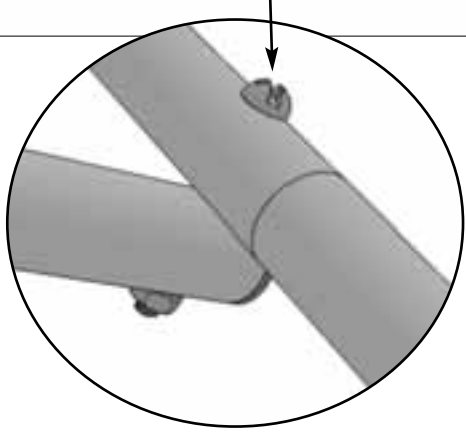
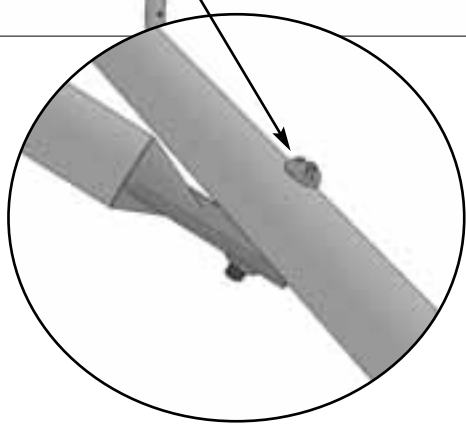
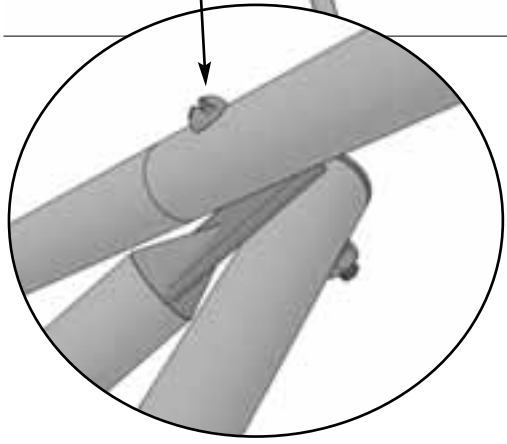
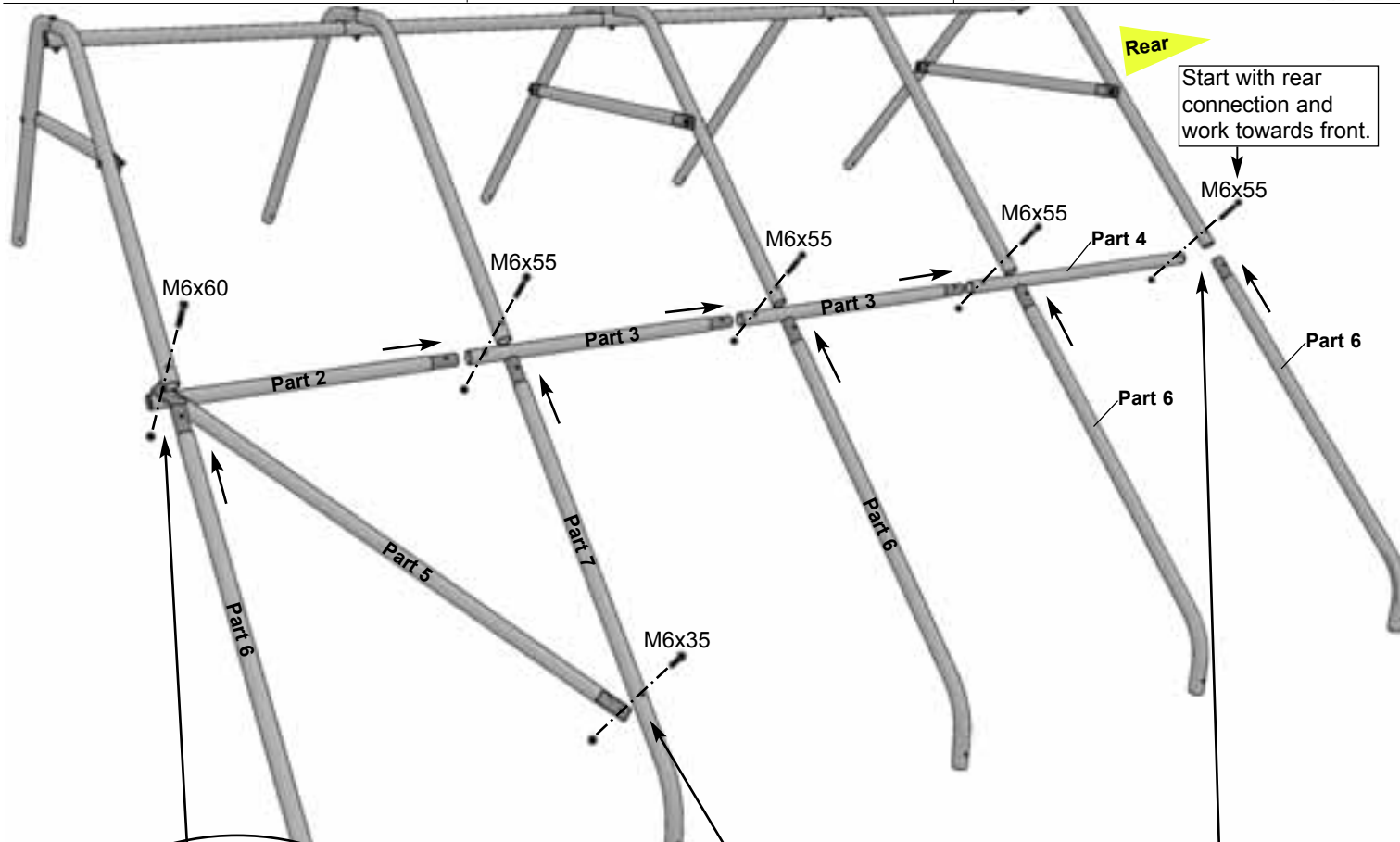

Step	Parts & Hardware	
	6	1 x Part 7
1 x Part 4		1 x Part 3
1 x Part 2		2 x Part 5

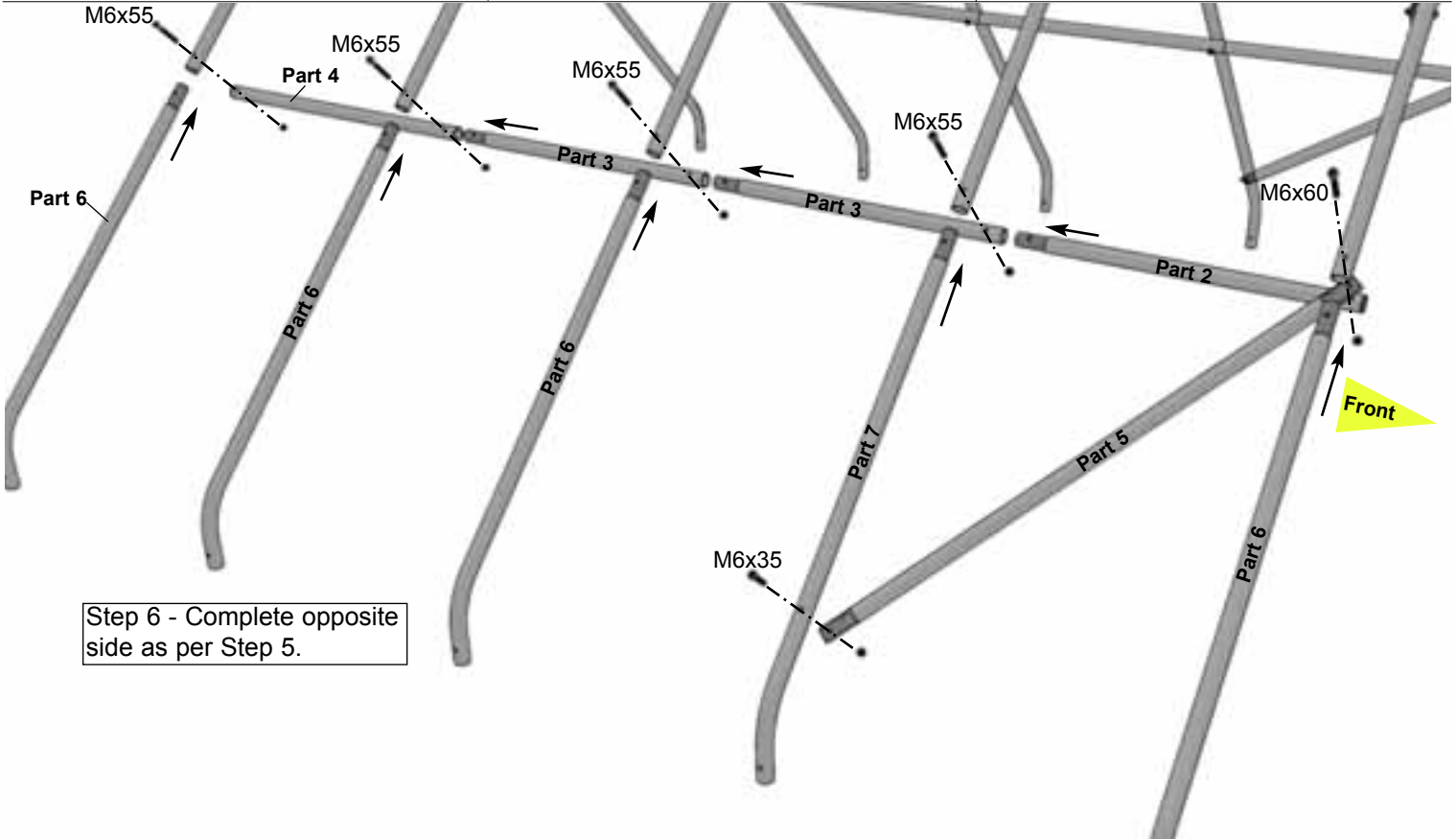
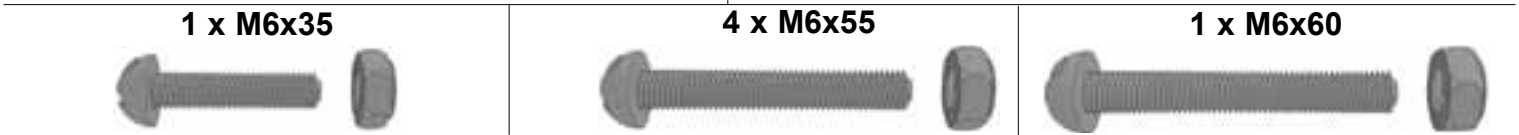

Step 6 - Complete opposite side as per Step 5.

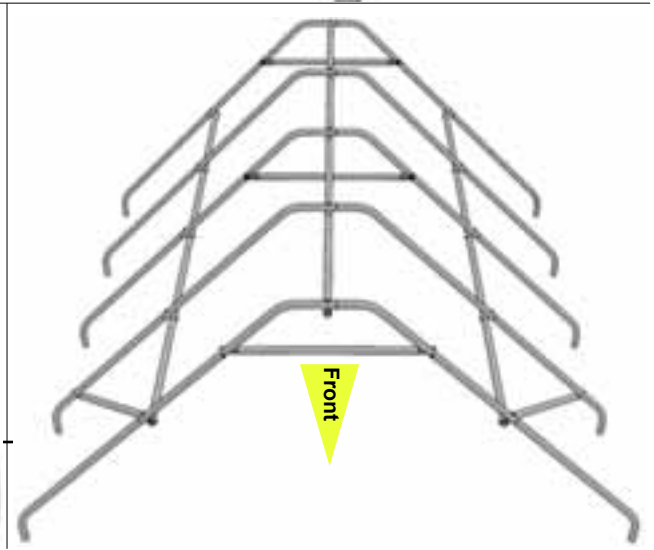
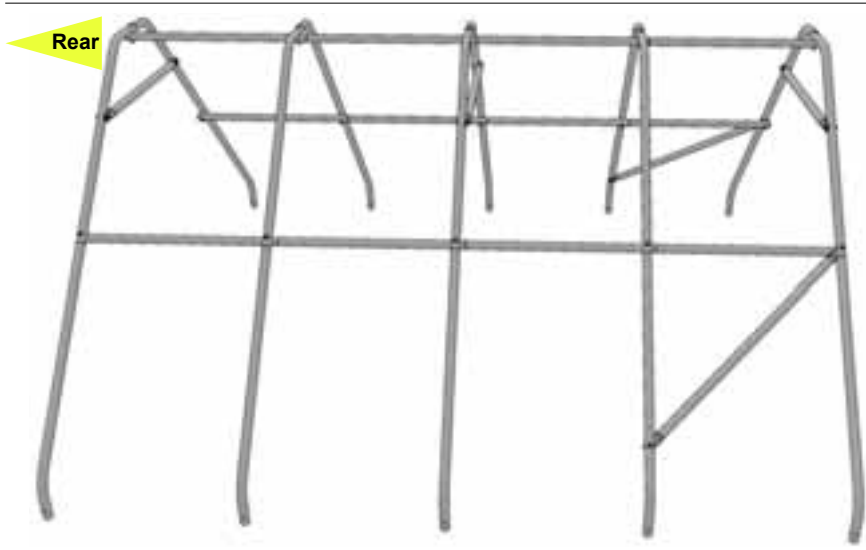

Step

Parts & Hardware

7

2 x Part 2

2 x Part 4

4 x Part 1

4 x M6x55

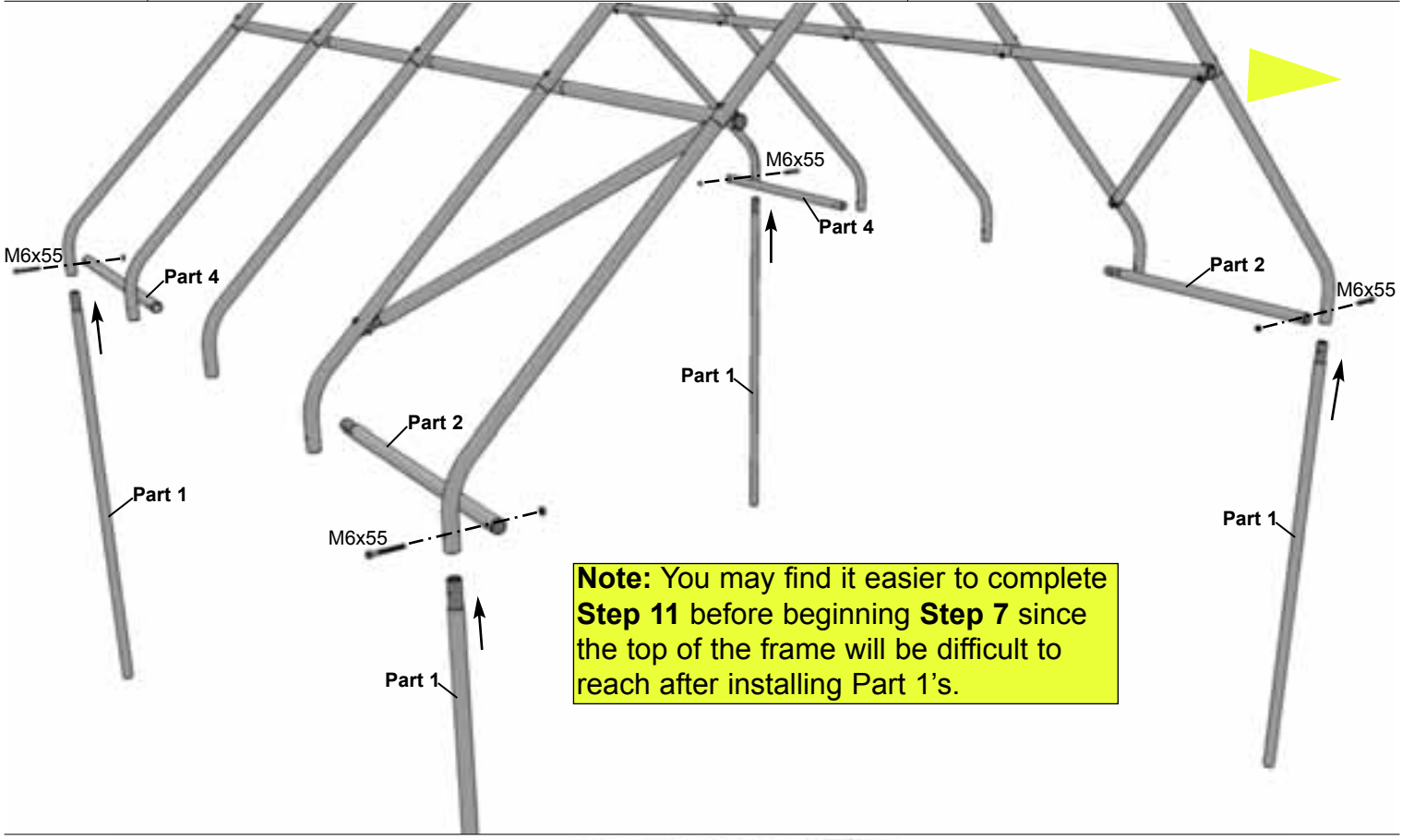

Note: You may find it easier to complete **Step 11** before beginning **Step 7** since the top of the frame will be difficult to reach after installing Part 1's.

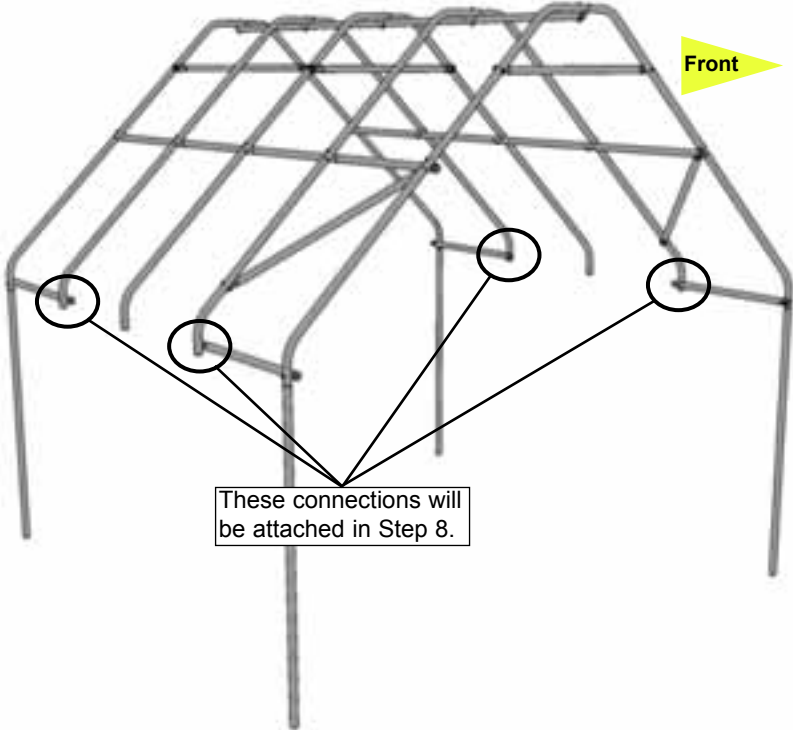

Step

8

Parts & Hardware

4 x Part 3



6 x M6x55



6 x Part 1

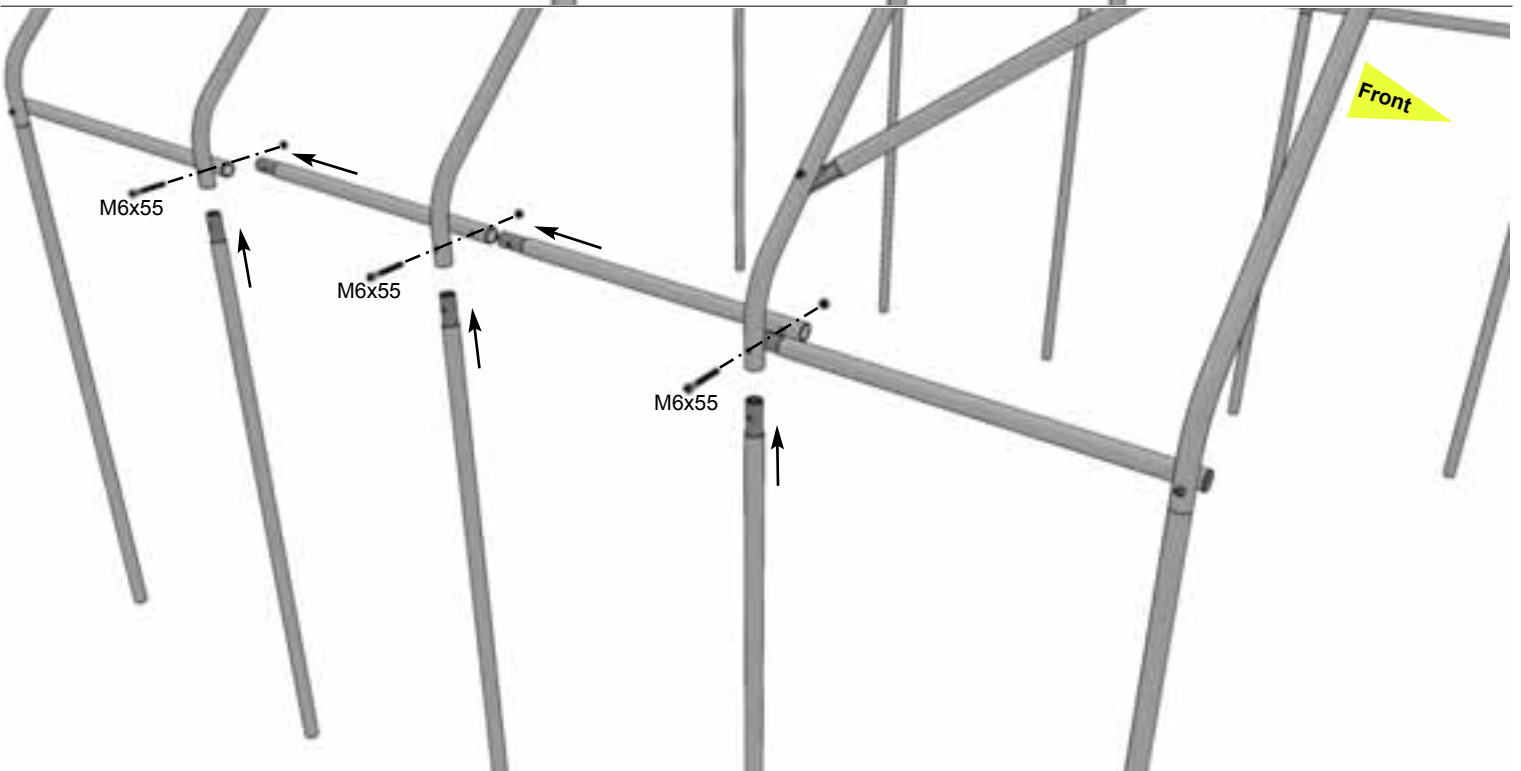
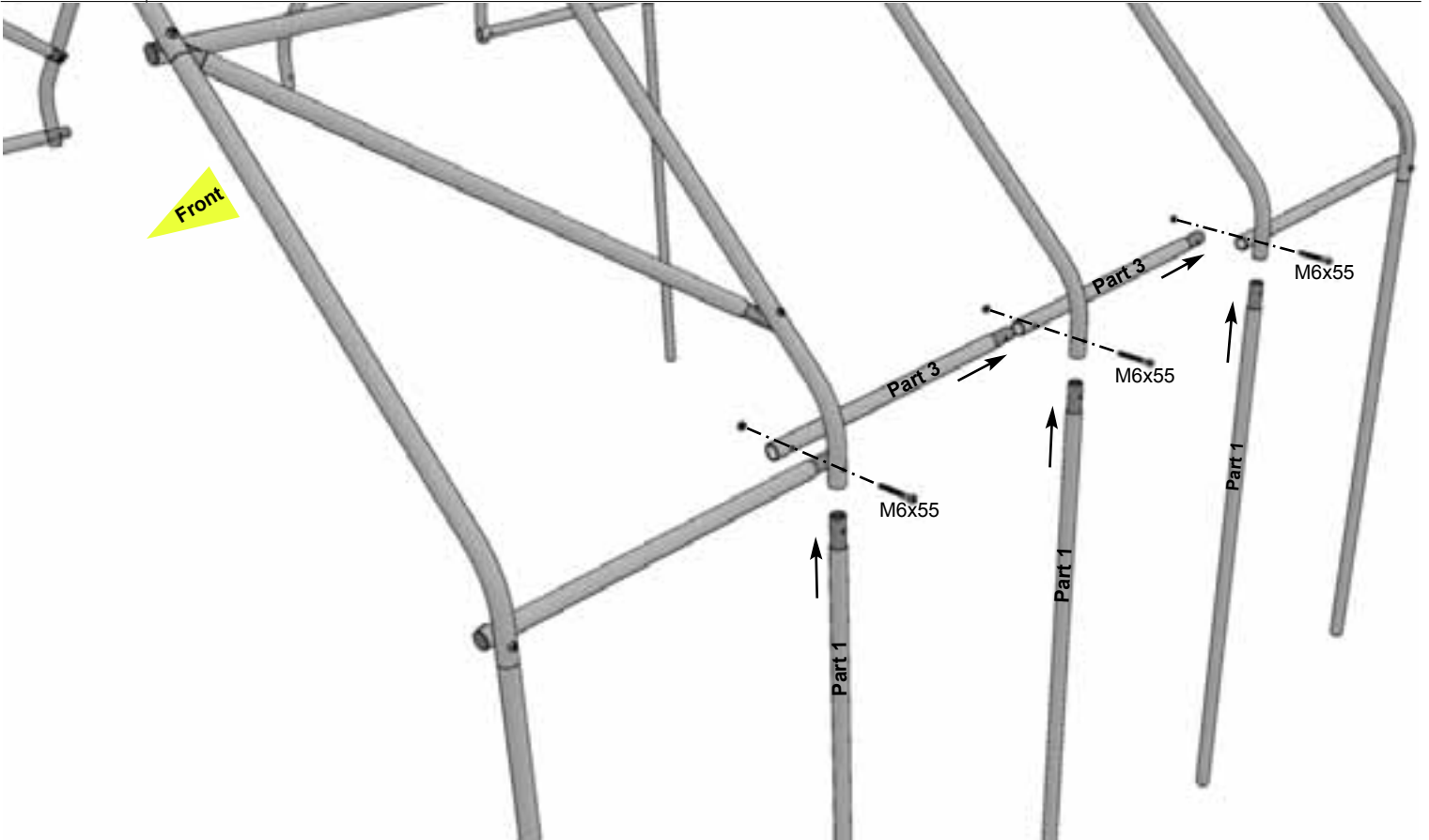

Step

9

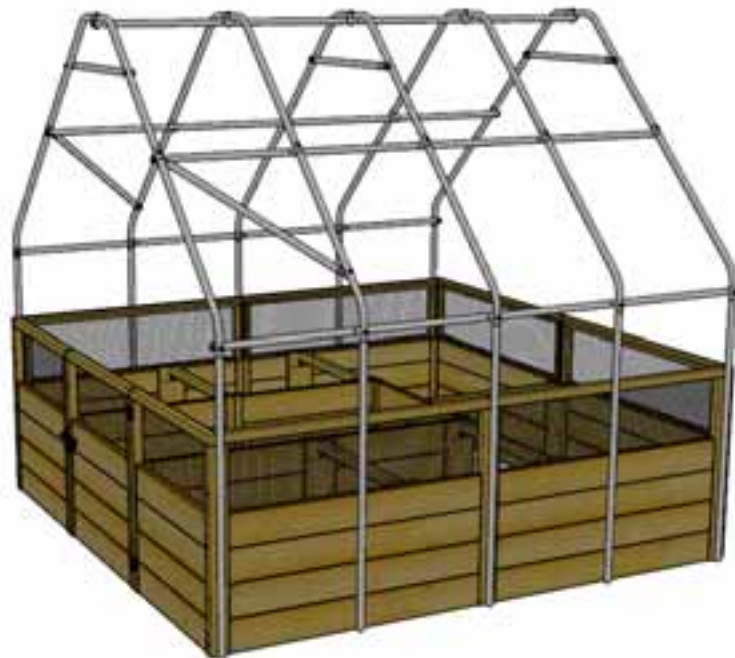
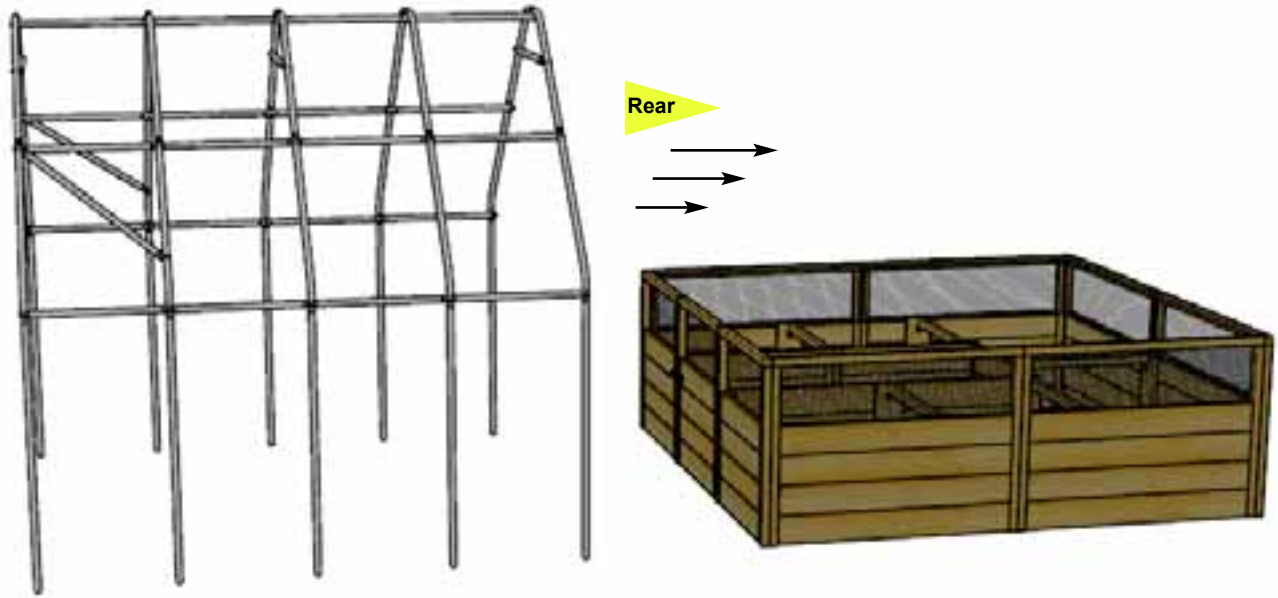

Step

Parts & Hardware

10

20 x Pipe Clamps



40 x S2 - 1 1/4" Screws

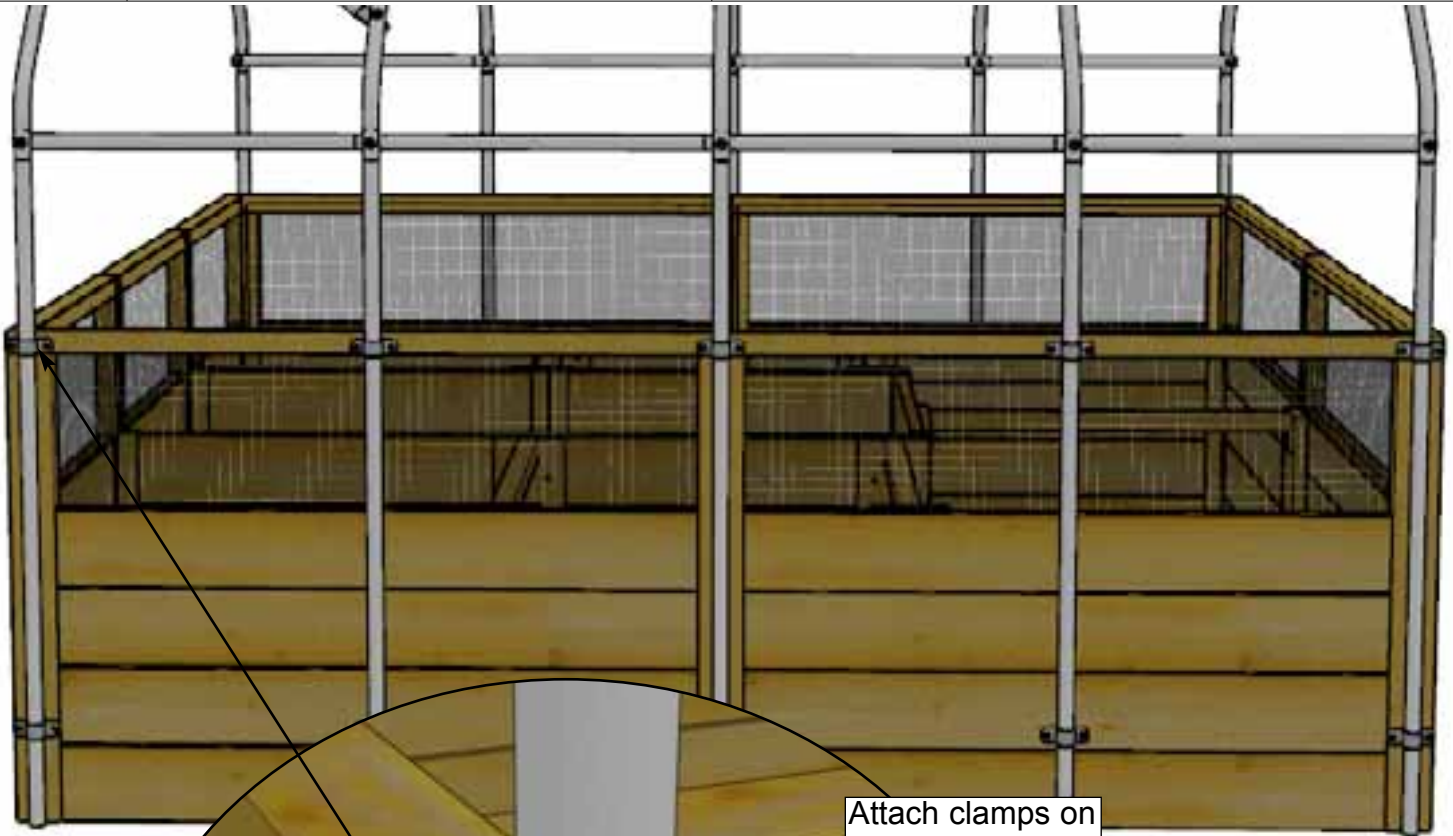

Note: Pre-drill pilot holes to prevent splitting.

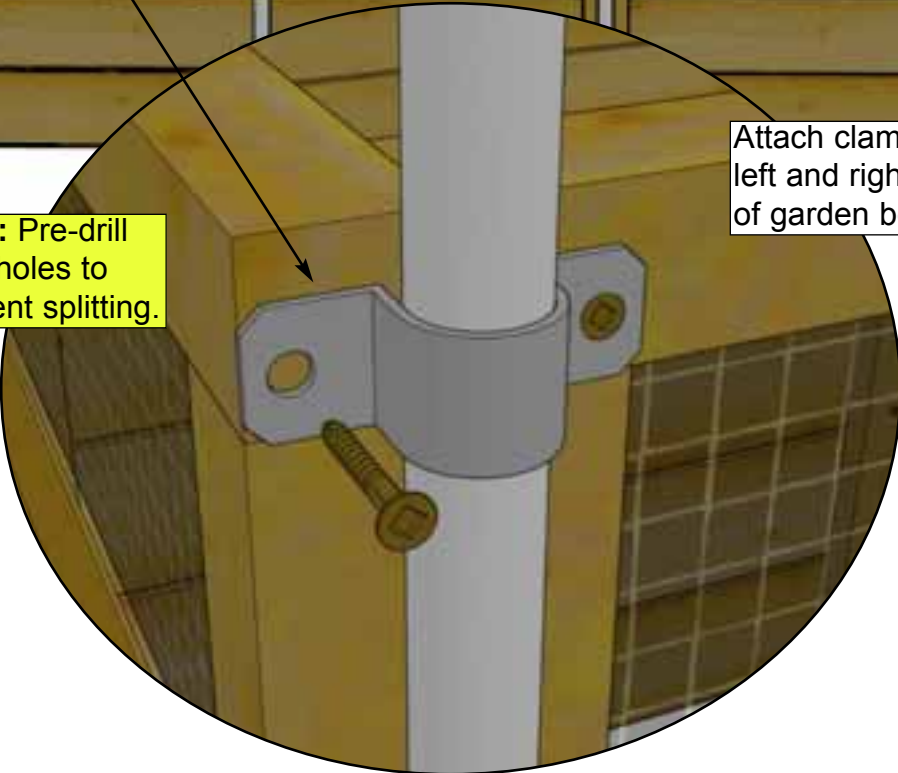

Attach clamps on left and right side of garden bed.

Step

11

Parts & Hardware



2x Protective Stripping Rolls

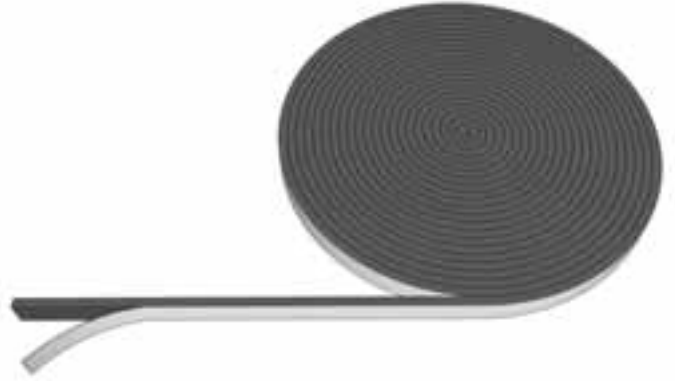

Peel off film to reveal adhesive side of protective stripping. Cover top of Greenhouse Frame with protective stripping as shown below. Start at the bottom of Part 6 as shown. Protective stripping will prevent your frame from damaging the cover.

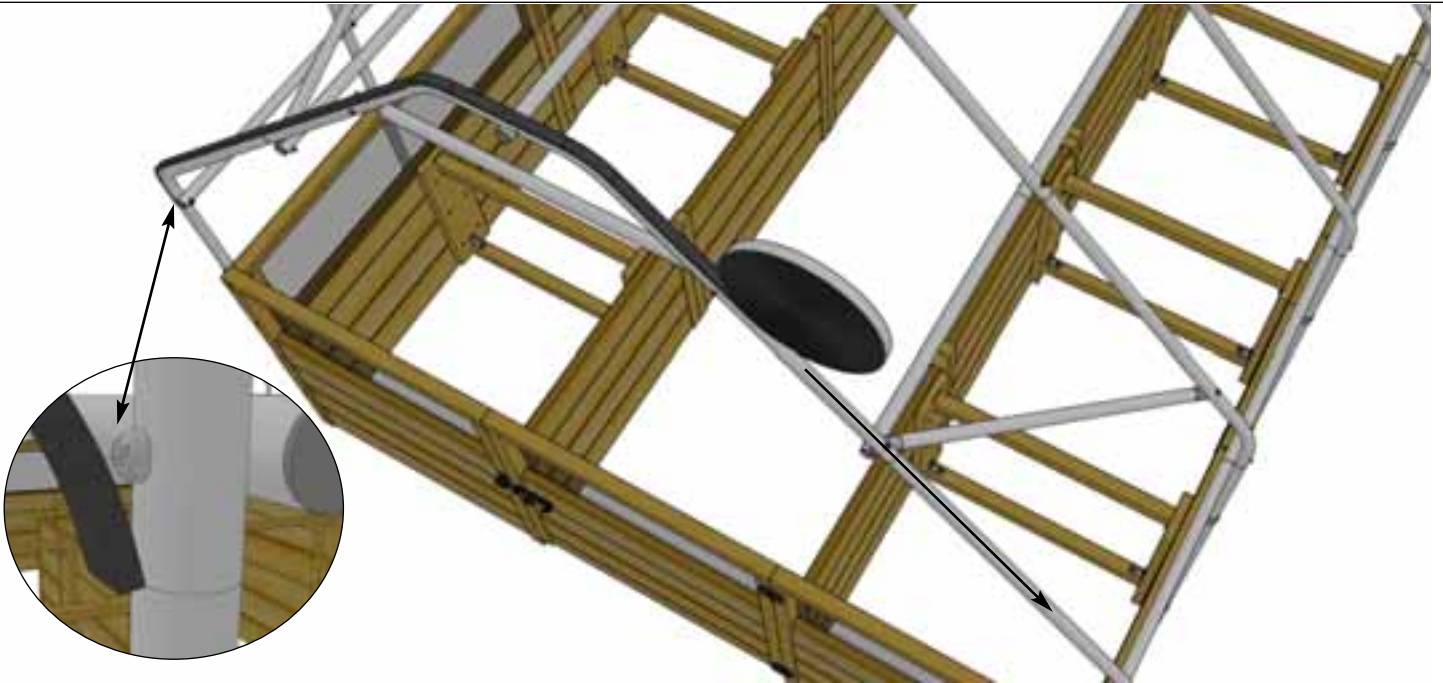

Step 12

Note: To fit the Greenhouse Cover on the frame, you will need to open the doorway of the cover.

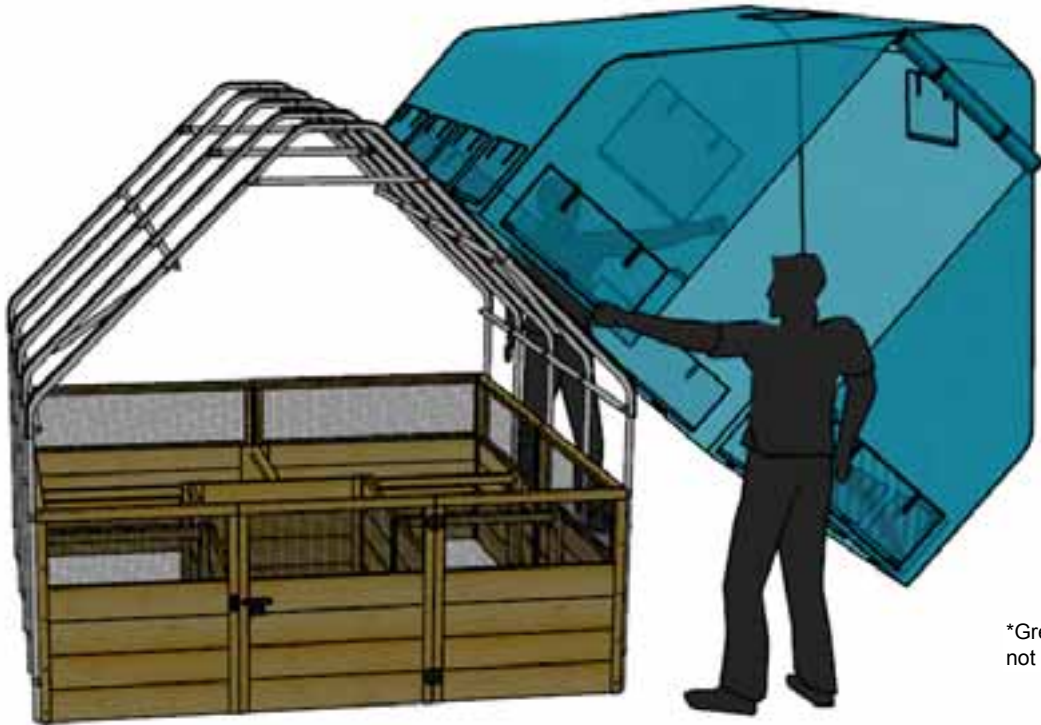

*Greenhouse Cover is not actually rigid.

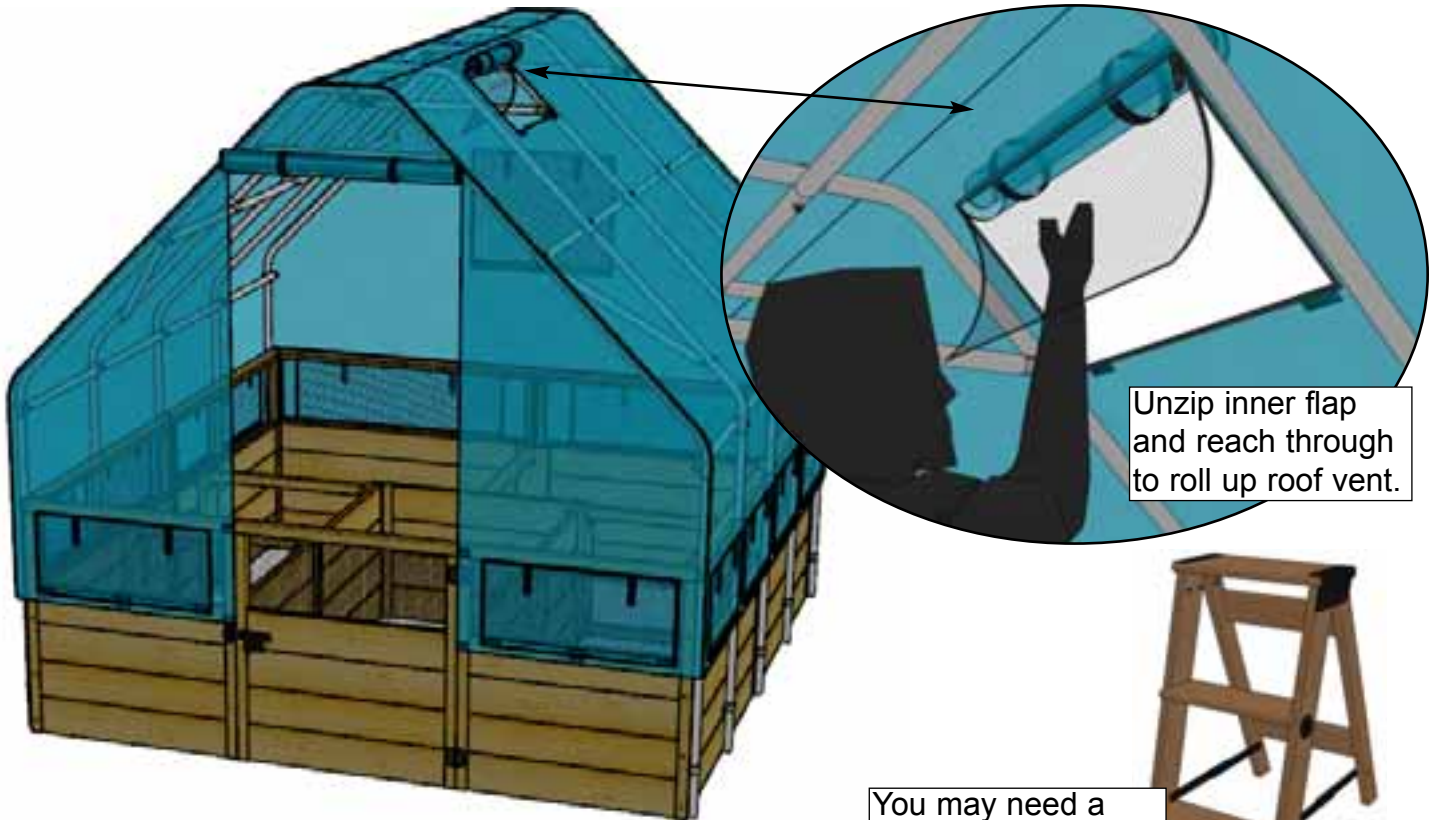

Unzip inner flap and reach through to roll up roof vent.

You may need a step ladder to reach the roof vents.

Step

Parts & Hardware

13

2 x Clips



2 x 1 1/4" Pan Head Screws



2 x Washers



Front of Unit

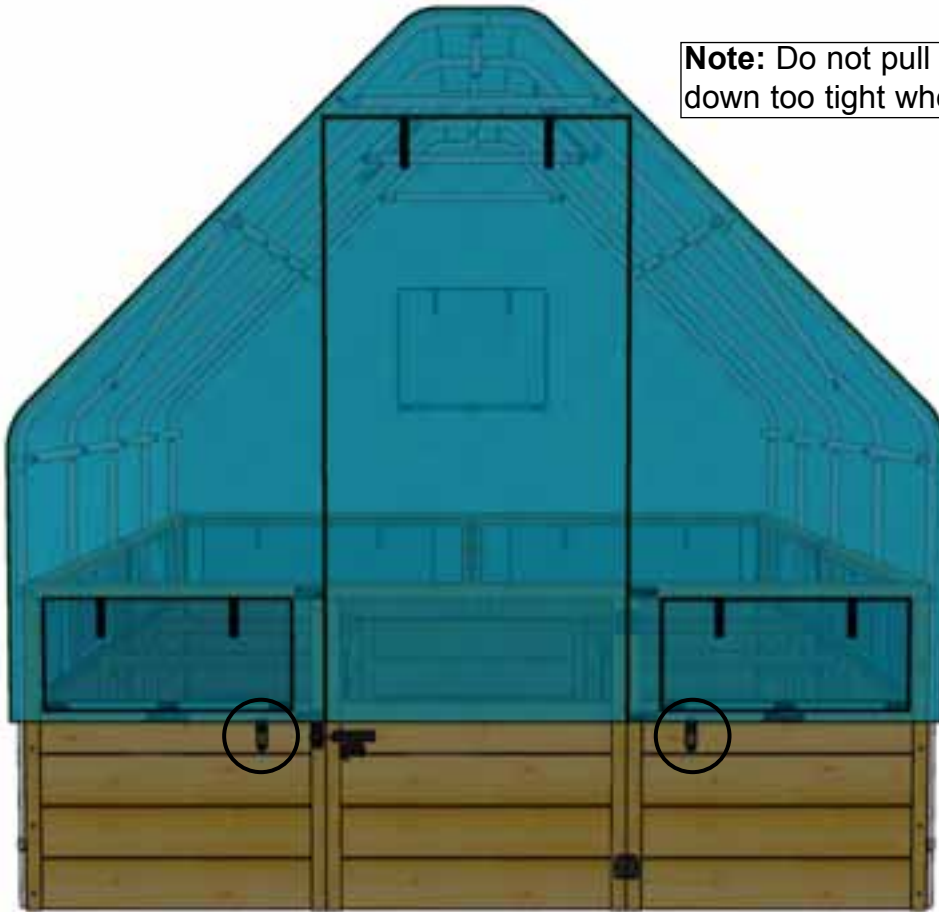

Note: Do not pull the Greenhouse Cover down too tight when attaching the clips.

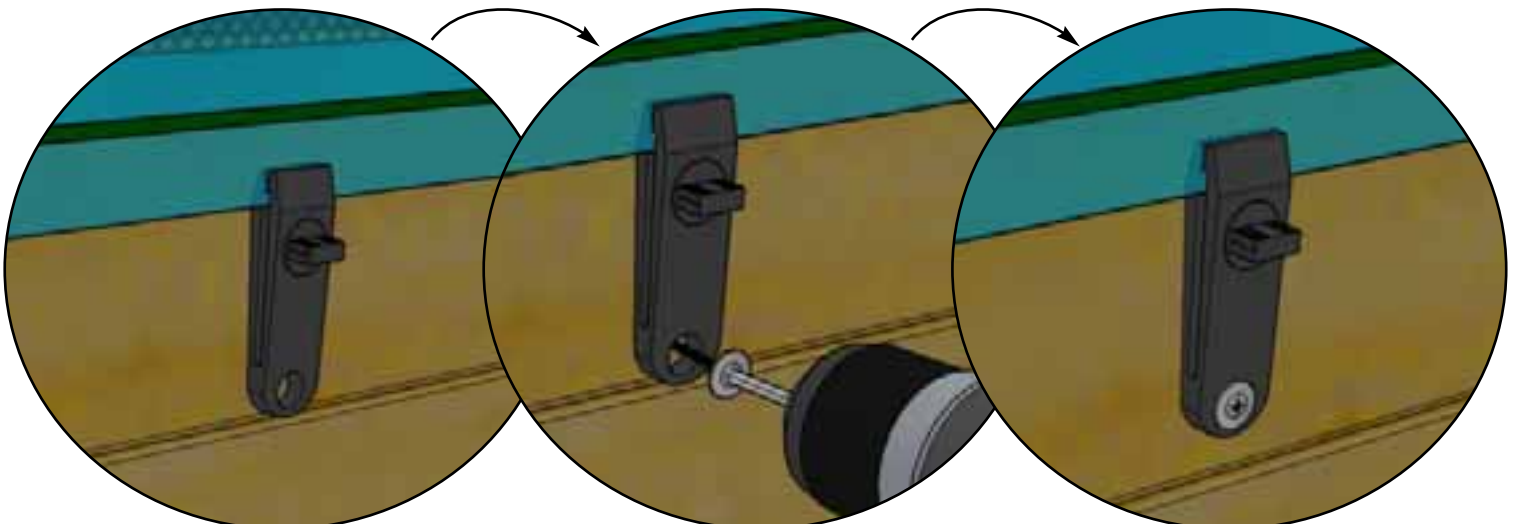

Step

Parts & Hardware

14

10 x Clips



10 x 1 1/4" Pan Head Screws

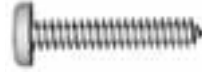

10 x Washers



Right Side of Unit

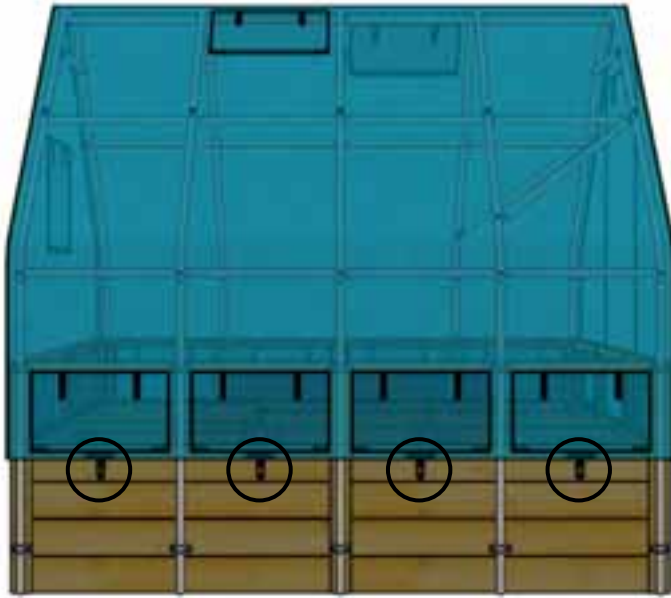

Left Side of Unit

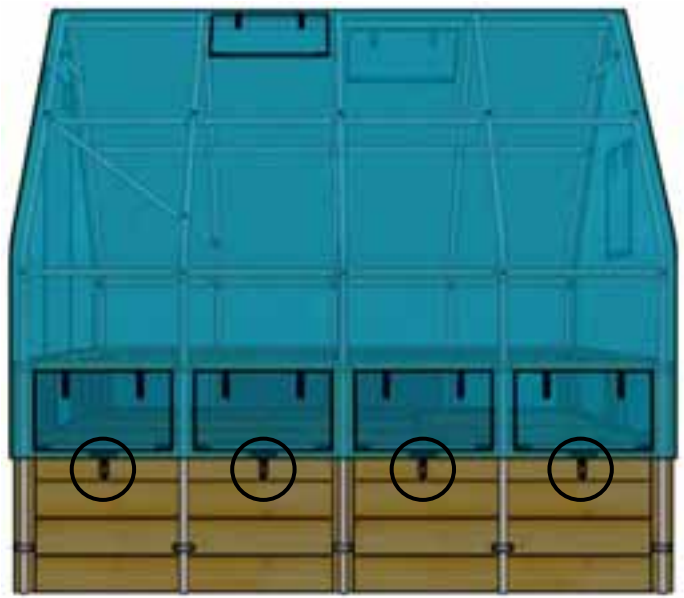

Rear of Unit

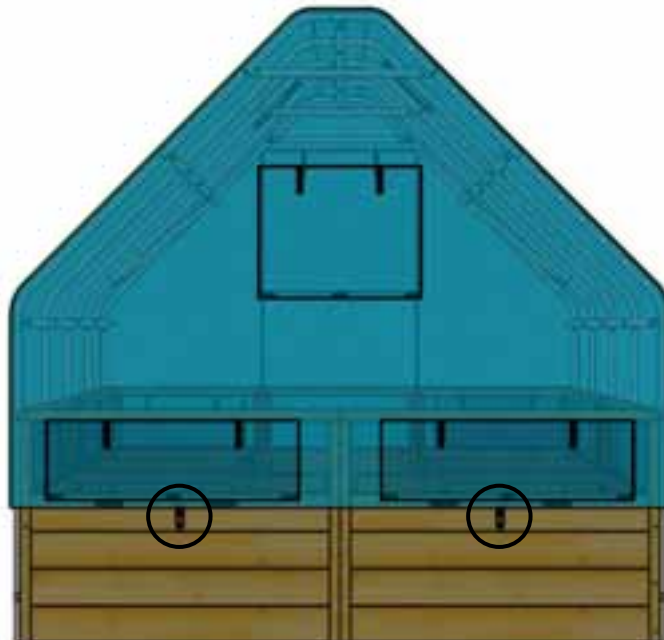



Outdoor
Living Today



Congratulations on
assembling your
8x8 Garden in a
Box Greenhouse
Cover!

We hope your experience constructing our **8x8 Garden in a Box Greenhouse Cover** has been both positive and rewarding. We value your feedback and would like to hear back from you on how well we are doing in the following areas:

- 1. Customer Service**
- 2. On Time Shipping**
- 3. Motor Freight Delivery**
- 4. Quality of Materials**
- 5. Assembly Manual**
- 6. Overall Satisfaction**



The materials contained in this Assembly Manual may be downloaded or copied provided that ALL copies retain the copyright and any other proprietary notices contained on the materials. No material may be modified, edited or taken out of context such that its use creates a false or misleading statement or impression as to the positions, statements or actions.

Please call, write or email us at:

Canadian Address
9393 287th Street
Maple Ridge, British Columbia
Canada V2W 1L1

United States Address
P.O. Box 96
Sumas, Washington
USA 98295