

PA-3256M

INSTRUCTION MANUAL

Hello! Please read these important attentions...

Please put a thick carpet on the ground to protect the furniture finish and corners. During the installation process, **DON' T** fasten screws tight 100% at a time.



FORM FOR REPLACING MISSING OR DAMAGED PIECES.

Please email to : customerservice@directwicker.com

Model # of product: _____
Ordered by: _____
Order No.: _____
Delivery date: _____

Were the boxes good when delivery to you Yes / No
Upon receiving the product, were all the parts intact Yes / No

Name: _____
Address: _____

Tel: _____

If the product is found damaged after assembly, please provide photos of the entire furniture set and all damaged areas.

Part#	Qty	Description	Missing/Damaged
			M / D
			M / D
			M / D
			M / D

If you do not receive a notification of the replacement parts within 1 week, please email us at customerservice@directwicker.com.





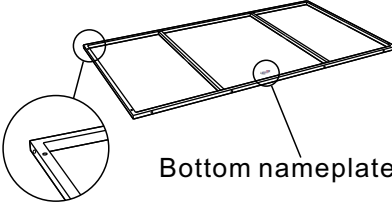
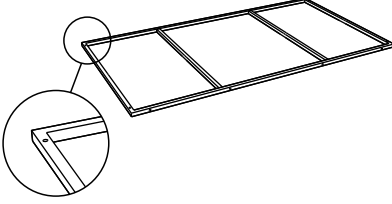
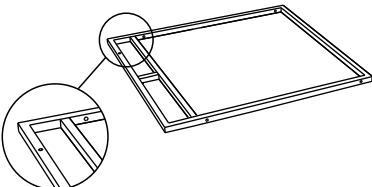
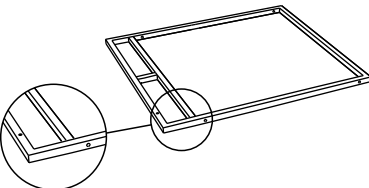
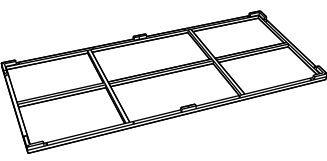
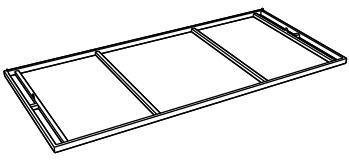



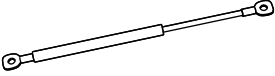

Assembly Instructions

Please read this before you proceed

A	 <p>Bottom nameplate</p>	Back panel	1pc
B		Front panel	1pc
C		Left side panel	1pc
D		Right side panel	1pc
E		Bottom panel	1pc
F		Top panel	1pc

Assembly Instructions

Please read this before you proceed

G		Gas Lift cylinder	2pcs
H		M6*35mm	20pcs
I		M6*15mm	6pcs
J		Washers	26pcs
K		Isolation column	6pcs
L		Nut	2pcs
M		Allen wrench	1pc
O		Spanner	1pc
P		Clamping knob	6pcs
Q		Liner	1pc

Assembly Instructions

- ① *Note: Please do not tighten all the screws before the products is fully installed, for it may cause assembling issues.



Velcro on top



Back screw hole



Side screw hole

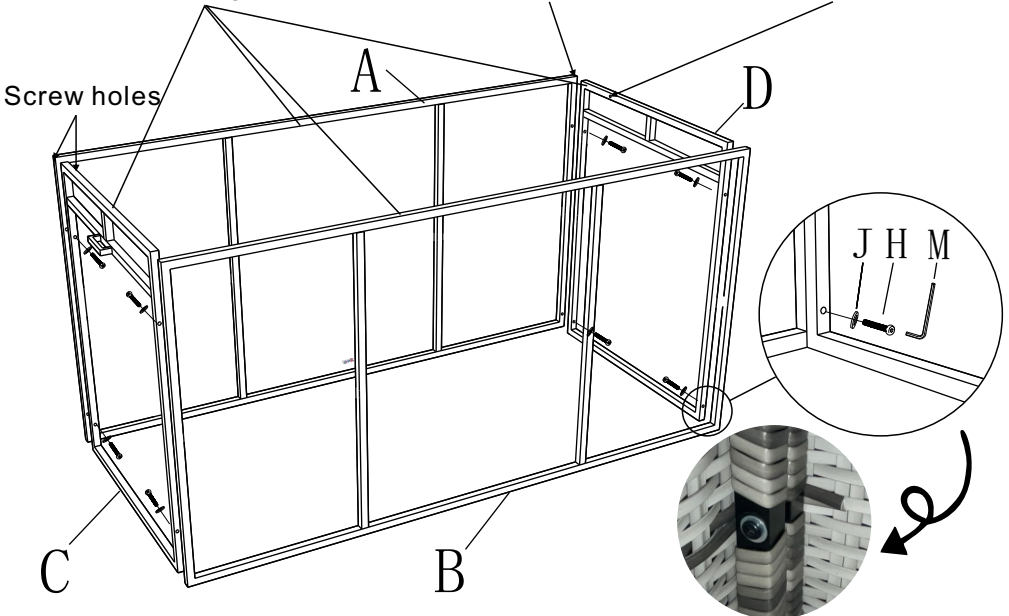

1. Use Allen wrenches (M), screws (H) and washers (J) to connect the four side panels (A) (B) (C) (D)
2. Place the side with the Velcro upwards.
3. The bolts near the Velcro on the inside of the side panels (C) (D) should be close to the back panel (A).
4. Back panel (A) and the front panel (B) are not the same. There are screw holes on the top of the back panel (A) for connecting the top panel (F)
5. Please do not tighten all the screws after connecting all side panels.

Assembly Instructions

2

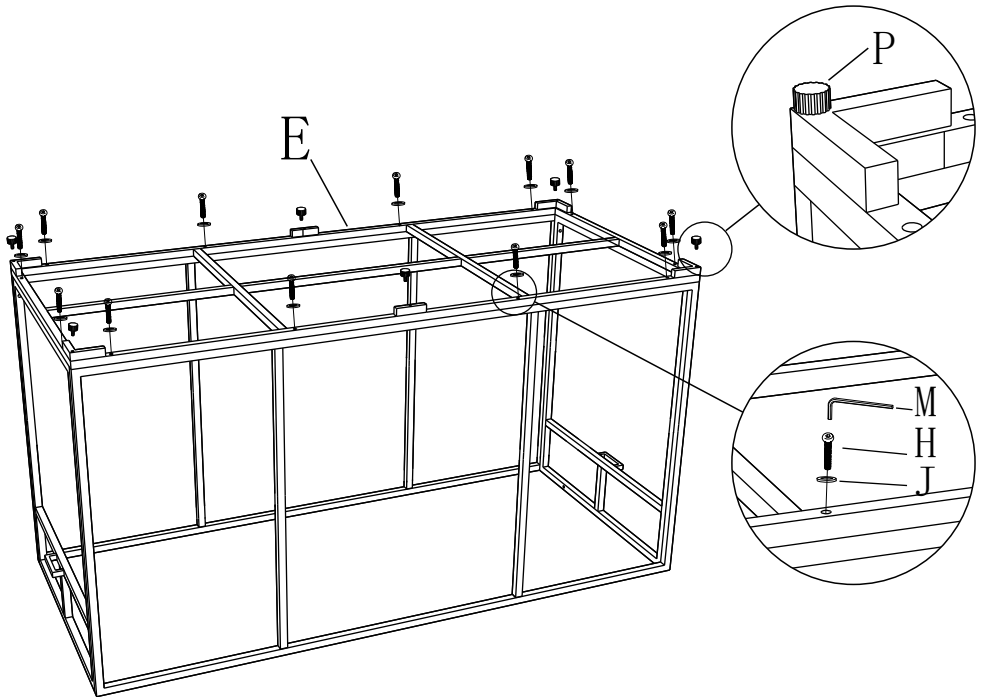

1. Turn the products upside down
2. Place the back panel (E) above the side panels
3. Use Allen wrench (M), screws (H) and washers (J) to connect the side panels and the bottom panel
4. Install the clamping knob (P) on the support foot

Assembly Instructions

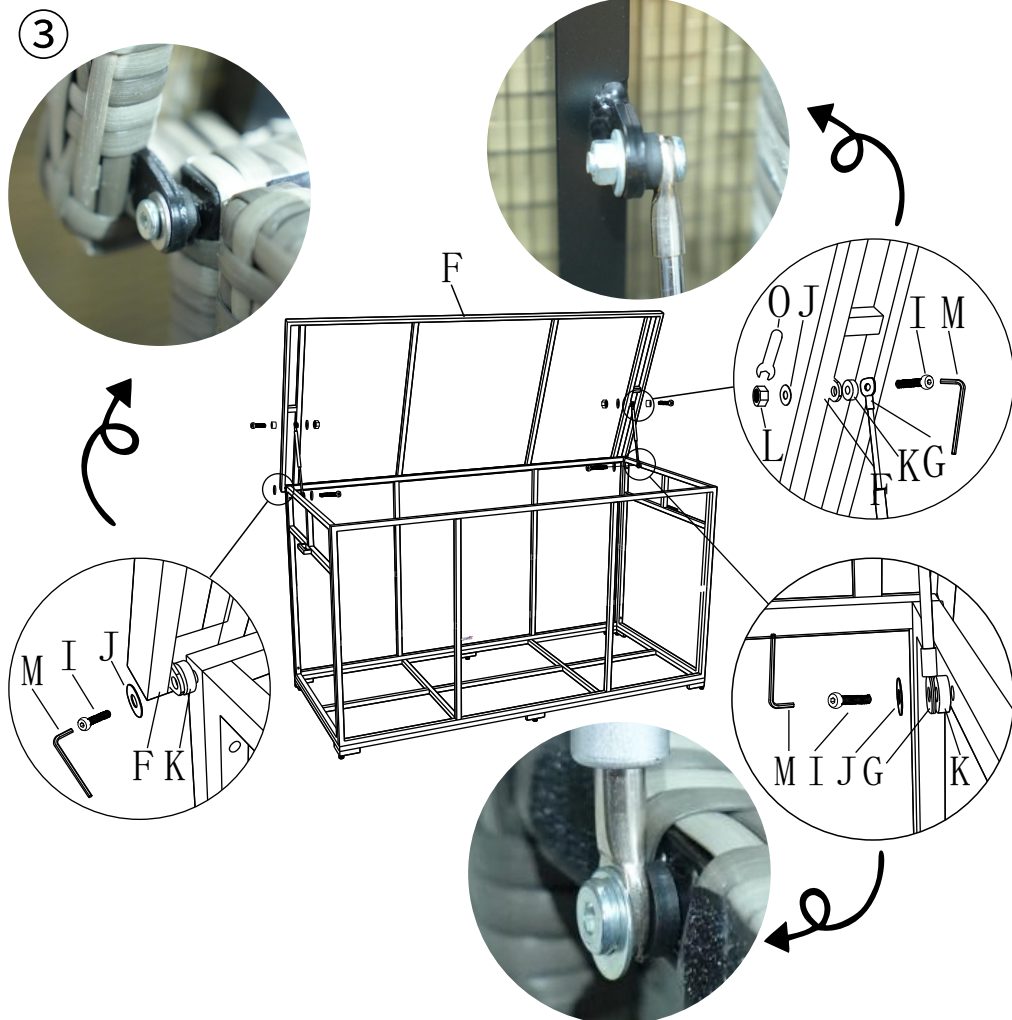

1. Turn the product upside down again so that the top is facing up
2. Use Allen wrench (M), screws (I) and washers (J) to connect the top panel (F) and the back panel (A). The Isolation column (K) needs to be placed between the connecting pieces of the back panel and the top panel (F) to avoid friction.
3. Open the lid (F), install the cylinder on the side of the lid with the side panel near Velcro .
4. Use (O)(L)(J)(K)(I)(M) to install the thicker side of the cylinder on the top plate (F), as shown in the picture
5. Use (M) (I) (J) (K) to connect the cylinder (G) to the side panels (C) (D), as shown in the picture

Assembly Instructions

④



Velcro



Zip up



Q

1. Open the liner (Q) and stick the Velcro near the zipper to the Velcro on all side panels.
2. Zip up the storage box to make it waterproof
3. When you need to take items, liner top can be stick to the Velcro on the top panel for easy putting in and out.

Congrats! You have completed assembling it-enjoy!



Customer Instruction Card

To our most beloved and valued customer:

Thank you for your order, and we appreciate your trust and support.

If you need any assistance or have any questions about your order, please reach our customer service team with your order number at:

Direct Wicker Corp Tel: (813) -304-1389

ET: 9 AM - 5 PM, Monday - Friday

If you would like to know more about Direct Wicker or need to forward documents, you can also reach us at: **customerservice@directwicker.com**

Our team will always be here to help.

Common Questions:

1. Normally the cushion is placed within the ottoman/ chair, please turn it upside down, you may find the cushion.
2. Please do not fully tighten the screws before all parts were assembled successfully, in case the products can not be lined up in position.
3. Furniture sets are mostly delivered in multiple cartons. If the numbers of boxes you received are not correct/missing. Please contact us via phone or email with your order number.
4. Our cushions are considered as shower proof, and we recommend that when the furniture set is not in use , cover it with a furniture cover or store it in dry place.
5. Always be careful when cleaning or handling glass (Always wear gloves and read the instructions of any household cleaner.) We do not advise placing hot objects such as tea or coffee pots directly onto the surface of the glass, always use coasters.
6. If you would like to return the order, be sure to also return any accessories and packing slips that came with your original package.

Thank you for your understanding and cooperation, we wish you a fantastic shopping experience with us, and we are looking forward to serving you again!

Direct Wicker Team

A stylized illustration of a hand holding a bouquet of flowers. The bouquet consists of several stems with small, colorful flowers in shades of pink, red, and light blue. The flowers are arranged in a circular pattern, and the stems are gathered together in a light-colored, textured paper or fabric wrap. The hand holding the bouquet is shown from the bottom right corner, with the fingers wrapped around the base of the bouquet.

Your Home Our Passion



For more information, please visit our website:
www.directwicker.com