

# Assembly Instructions

**Caution:** You should read this carefully before proceeding

Please look in the **Table Top** for hardware packs.

## Loveseat

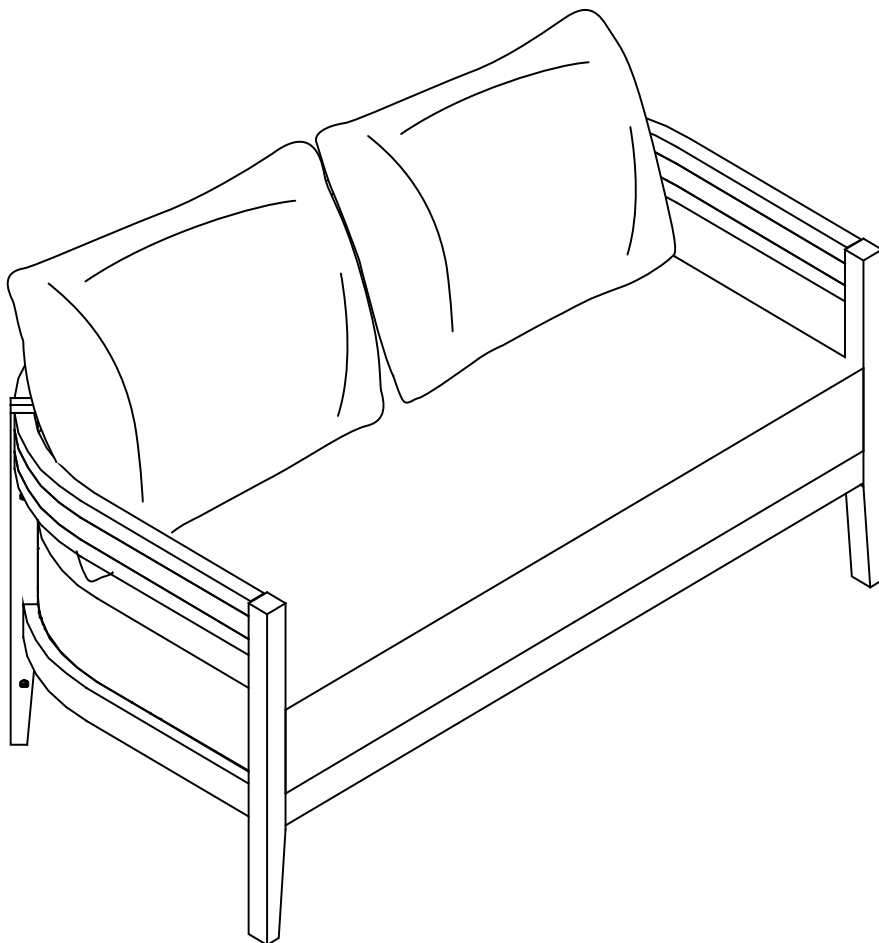

**Caution:** This Loveseat is NOT a TOY.



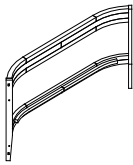
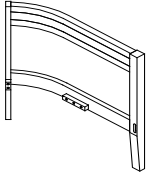
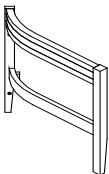
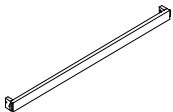
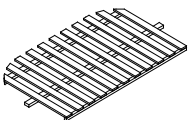
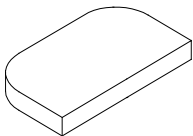
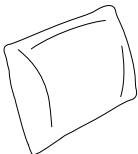

Keep your child / children at bay in the process of assembly.

Whenever moving or lifting the Loveseat and to prevent any damage to it, two adults may be needed to execute these actions.

# Parts List

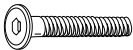
Label	Picture	Description	QTY
C		Backrest Panel	1
D		Left Leg Panel	1
E		Right Leg Panel	1
F		Support Bar	1
G		Seat Panel	1
H		Seat Cushion	1
I		Back Cushion	2





# Hardware

Label	Picture	Description	QTY
④		Bolt (M6x30mm)	5
⑤		Bolt (M6x45mm)	5
⑥		Screws (M6x35mm)	7
⑦		Sleeve Nut (M6x15mm)	5
⑧		Allen Key	2

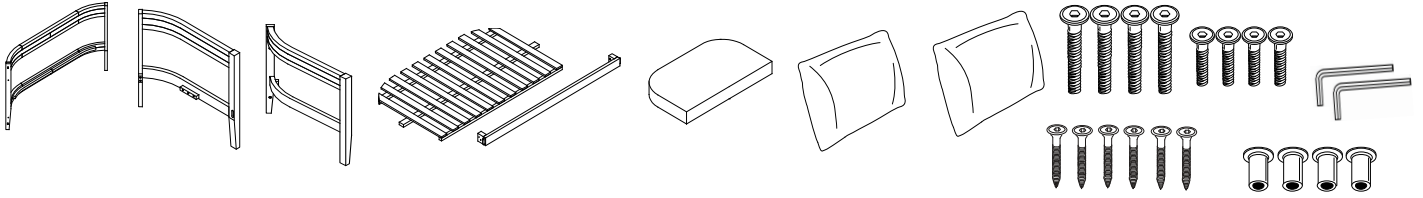
# Assembly Preparation

## Before Beginning Assembly:



-  • Read instructions, cover to cover-
-  • Have 2 adults on hand for assembly-
-  • Do not assemble on flooring or carpet-
-  • Assemble on a clean non-marring surface (packing foam)-
-  • Save all packaging until finished-

# Assembly Steps

## Overview

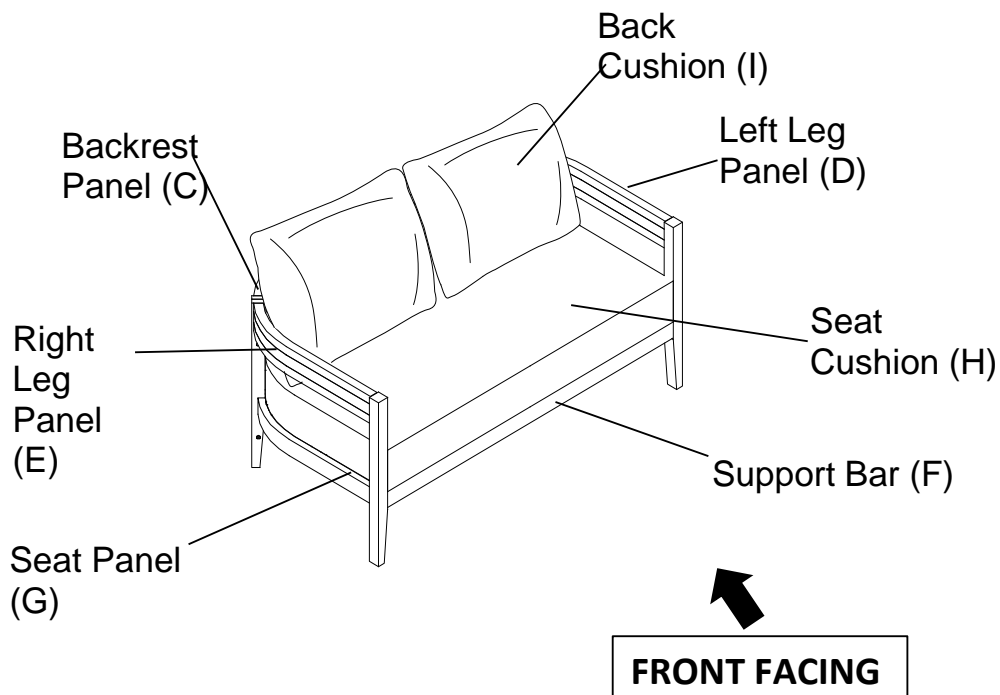

This Loveseat has multiple parts and may require up to 30 minutes to assemble. To give you an overview of the Loveseat parts, the above picture is provided to help you put the various parts into perspective. Please read through the instructions below to familiarise yourself with the parts and steps before assembly.

## Step 1

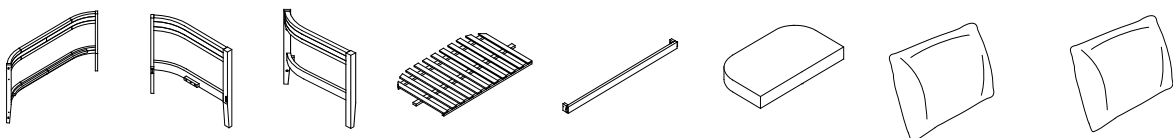

Unpack and place all parts on a clean, non-marring surface.

## Step 2

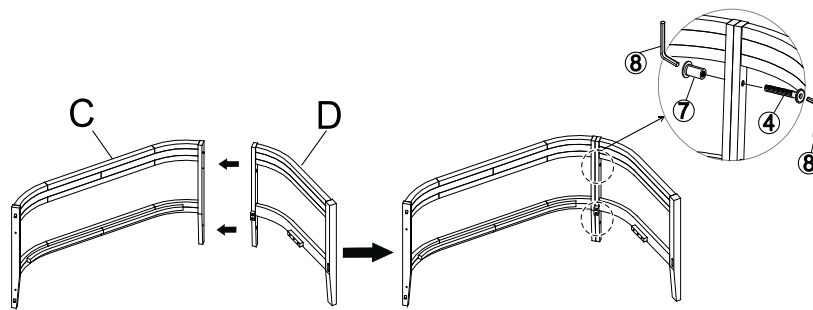

Place the Backrest Panel (C) standing up as shown in picture above, onto a clean, soft surface to avoid any scratches or damage to the product.

With assistance from your adult partner(s), Attach the Left Leg Panel (D) to the Backrest Panel (C) using Bolts(④), Sleeve Nuts(⑦) and the Allen Key(⑧) as shown above.

**Do not fully tighten the Bolts at this time.**

## Step 3

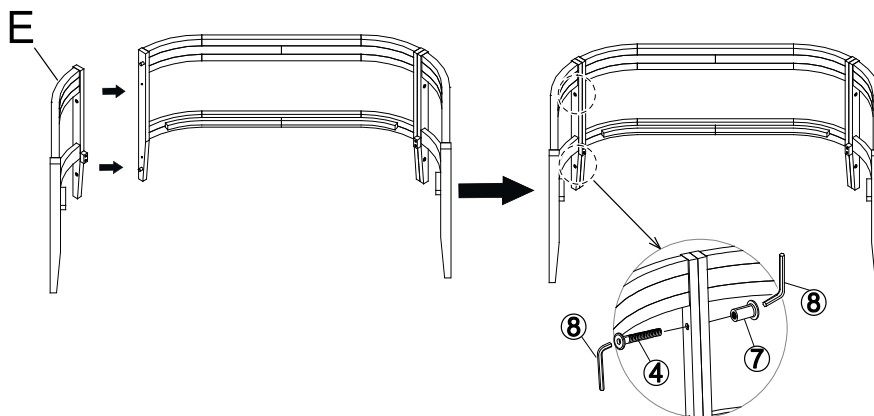

Attach the Right Leg Panel (E) to the pre-assembled in step 2 using Bolts(④), Sleeve Nuts(⑦) and the Allen Key(⑧) as shown above.

**Do not fully tighten the Bolts at this time.**

## Step 4

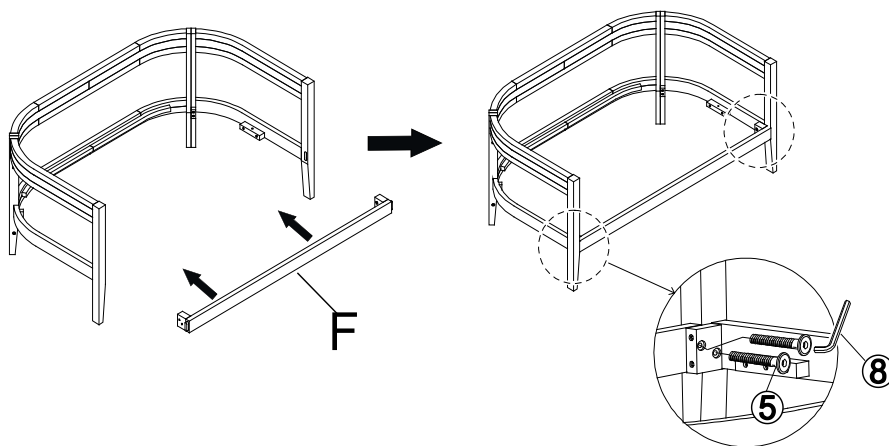

With assistance from your adult partner(s), attach the Support Bar (F) to the assembled frame in step 3 using Bolts(⑤) and the Allen Key(⑧) as shown above.

## Step 5

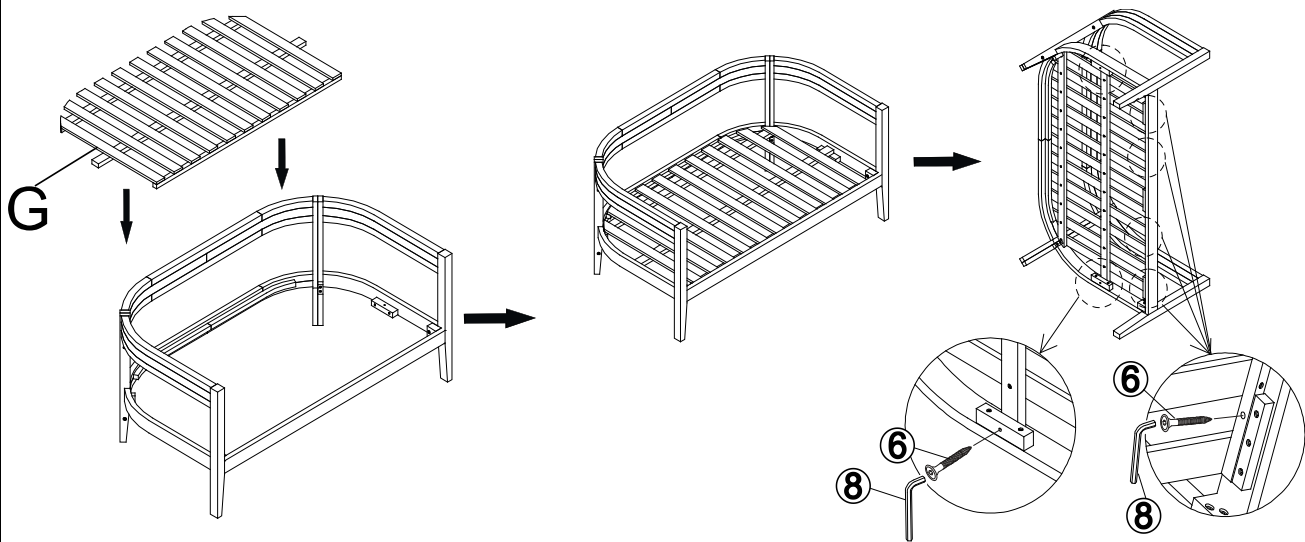

Attach the Seat Panel (G) into the Loveseat as shown in picture above.  
Affix the Seat Panel (G) to the Loveseat frame using Screws(⑥ ) and the Allen Key(⑧ ).  
Note: Insert the Screws(⑥ ) from the inside to the outside of the Seat Panel (G)

**DO NOT FULLY TIGHTEN SCREWS.**

**Turn the Loveseat right side up.**

**Inspect the Loveseat and make sure all parts are adequately connected.**

**Carefully sit on the Loveseat. This pressure will help align all parts at all joints.**

**In a sequential manner, tighten all Bolts and Screws at all joints.**

## Step 6

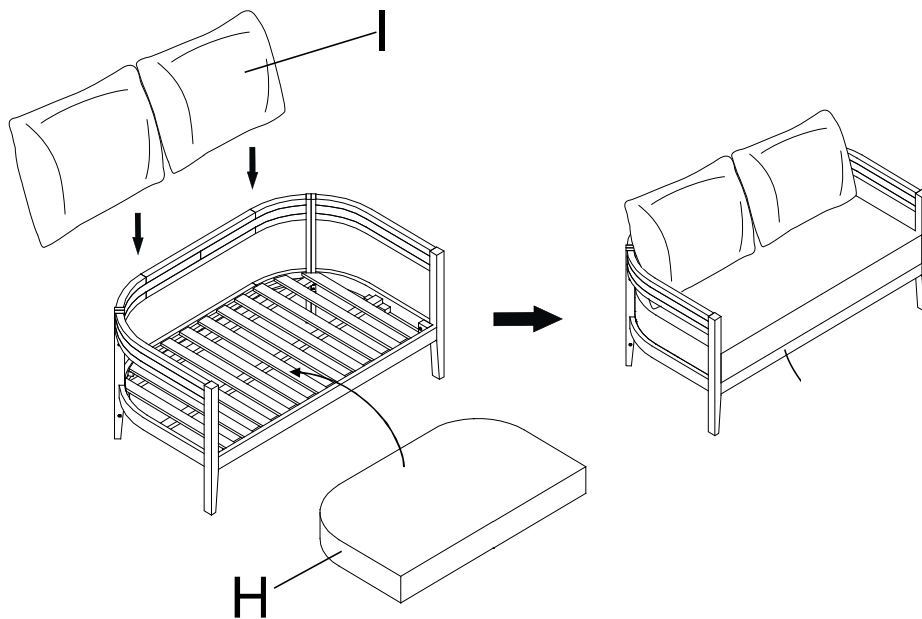









Place the Seat Cushion (H) and the Back Cushions (I) onto the Loveseat, and affix the velcro straps around it as shown above.

Your Loveseat is ready to be used.

**This Loveseat can only be used on a flat, level surface.**

## Care & Maintenance

-  ● Do not put hot items directly on furniture surface
  -  ● Do not clean furniture with harsh cleansers or polish.
  -  ● To obtain the longest lifespan of your outdoor products, minimizing exposure to direct sunlight is recommended.
  -  ● Children should not climb or jump on the furniture.
  -  ● Do not write on furniture without a padded barrier to protect the surface.
  -  ● To obtain the longest lifespan of your outdoor products, avoid extended and lengthy exposure to rain, snow, and direct sunshine. Whenever possible cover the product and /or place under patio or awnings.
  -  ● Not for commercial use. For residential use only .
  -  ● Stains may be removed with mild soap solution and damp cloth.
- 
-  ● Dust and pick-up spills using a clean, non-colored, lint-free cloth .