

















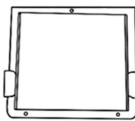

SWITTE Egg Swing Chair Installation Instructions

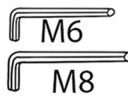

Online Support: kannel_service@outlook.com
Feel free to Contact Installation Instructor Team!

			
A 1	B 1	C 4	D 1
			
E 1	F 1	G 1	H 1
	 reinforcement		
I 1	J 4	K 1	L 1
			 height adjuster
M 1	Hexwrench	Wrench	N 4
			
M8-60mm 1	M6-40mm 2	M6-30mm 1	M8-20mm 2

Step 1:

Screw the 4 height adjusters (**N**) into the ends of the 4 support legs (**C**).

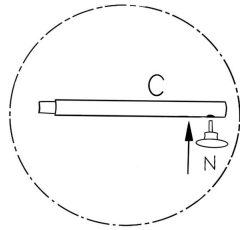

Step 2:

Attach the 4 support legs (**C**) to the base frame (**A**) using the reinforcement plates (**J**).

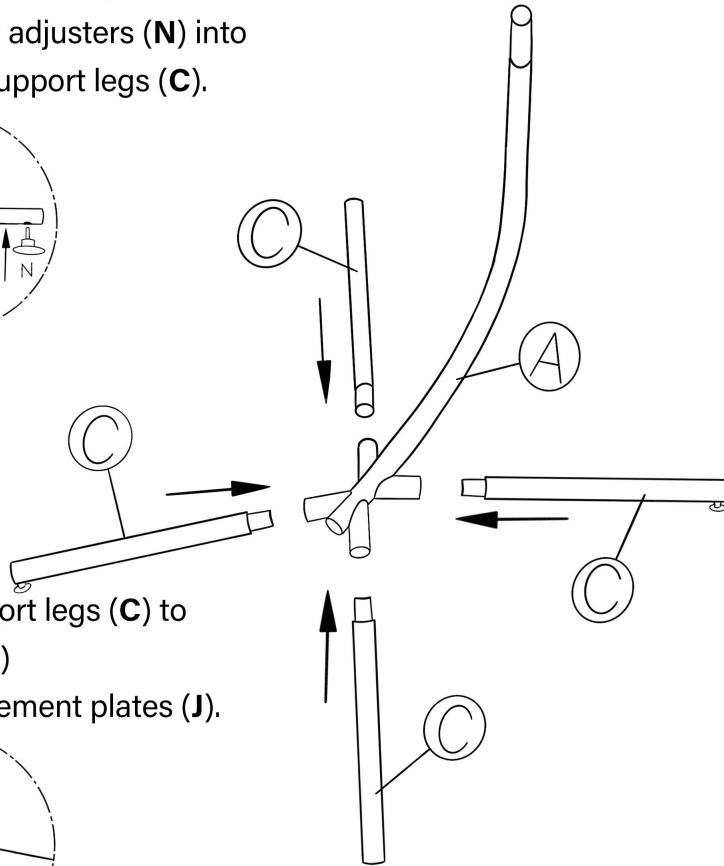
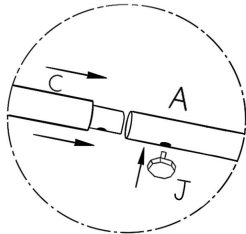

Step 3:

Connect the base frame (A) to the upright tube (B) using 1 M8×60mm screw.

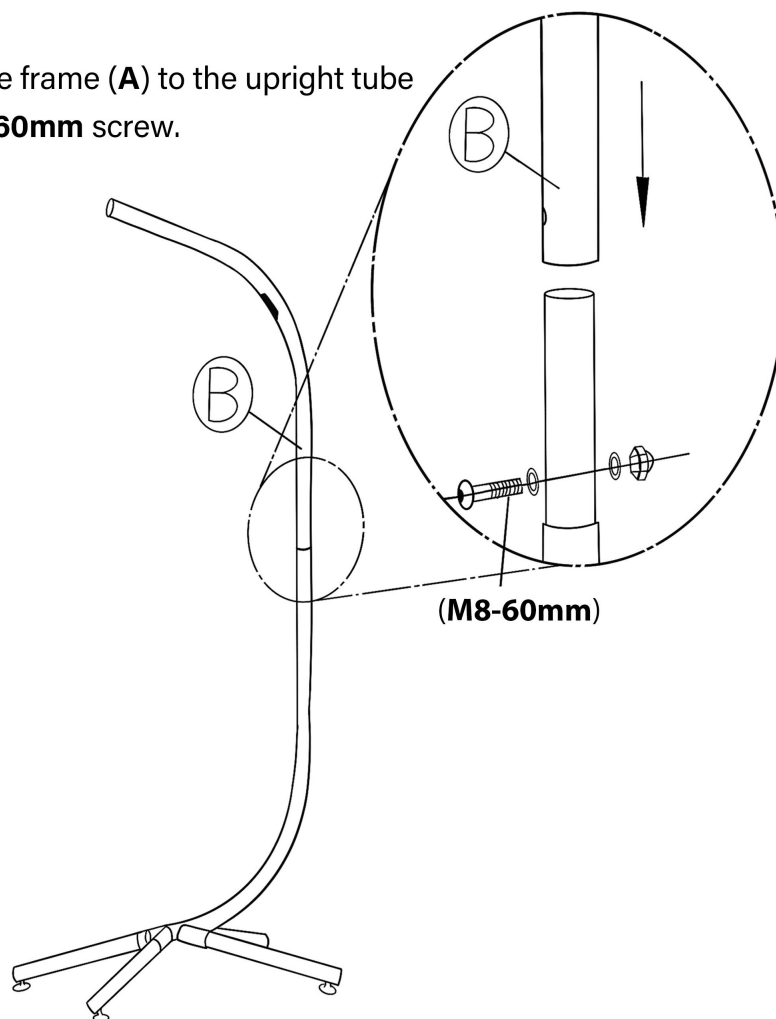

Step 4: Secure part **(K)** to the bottom of part **(D)**
using **1 M6×30mm** screw and **2 M6×40mm** screws.

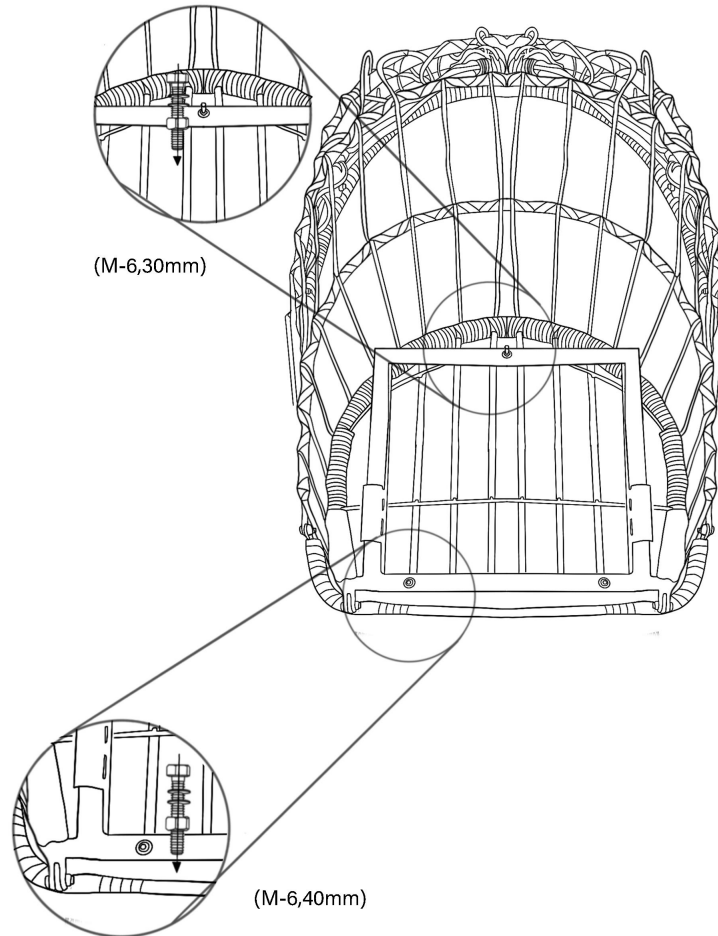

Step 5:

Insert part (L) through the round tube
at the top of part (K).

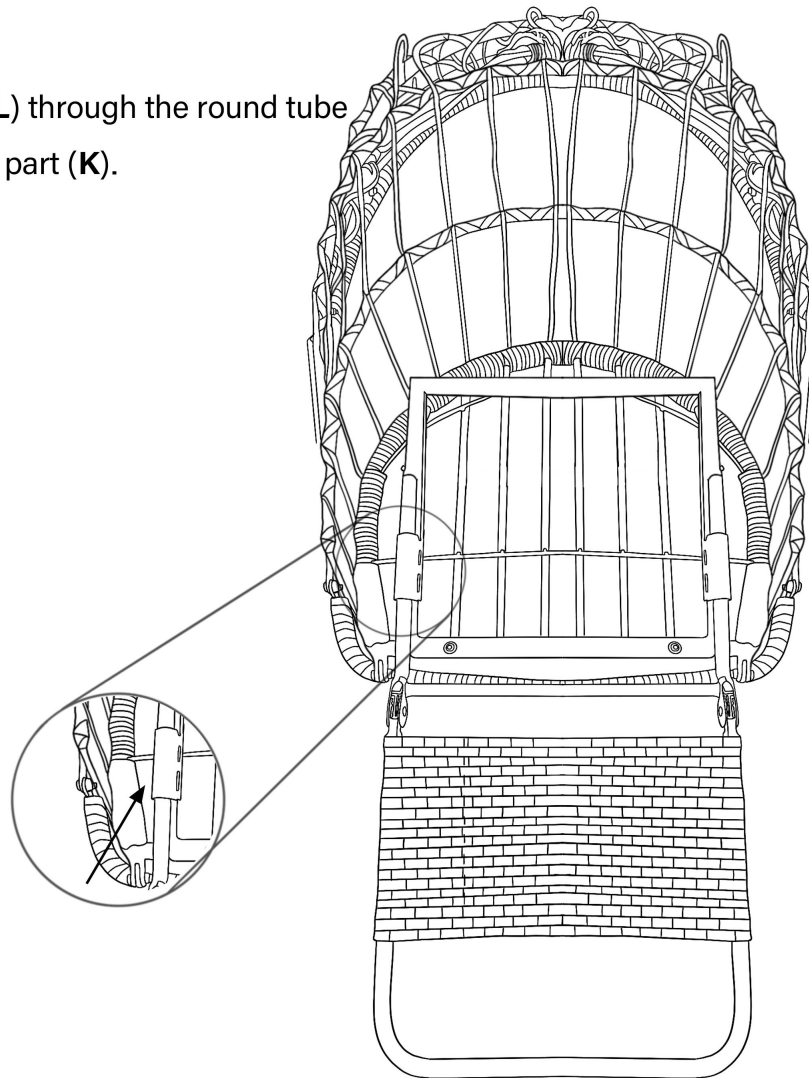

Step 6:

Fix part (M) to the two holes at the end of part (L) using 2 M8×20mm screws.

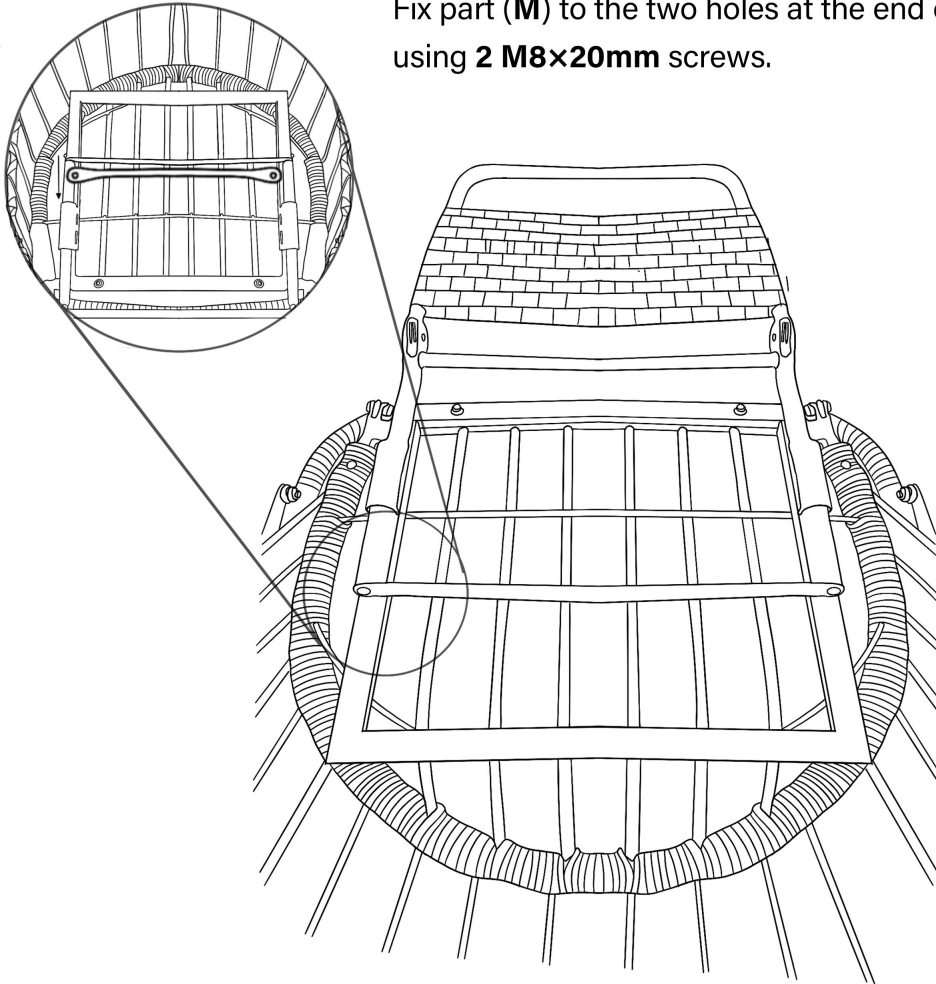

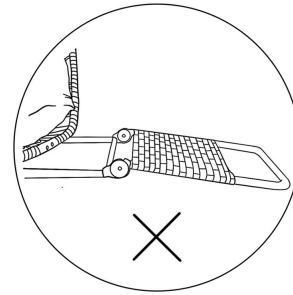

Wrong version
Footrests facing down

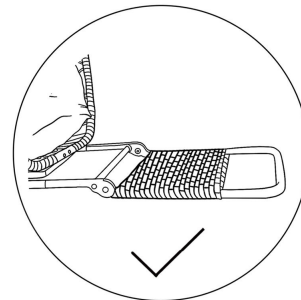

Correct version
Footrests facing up

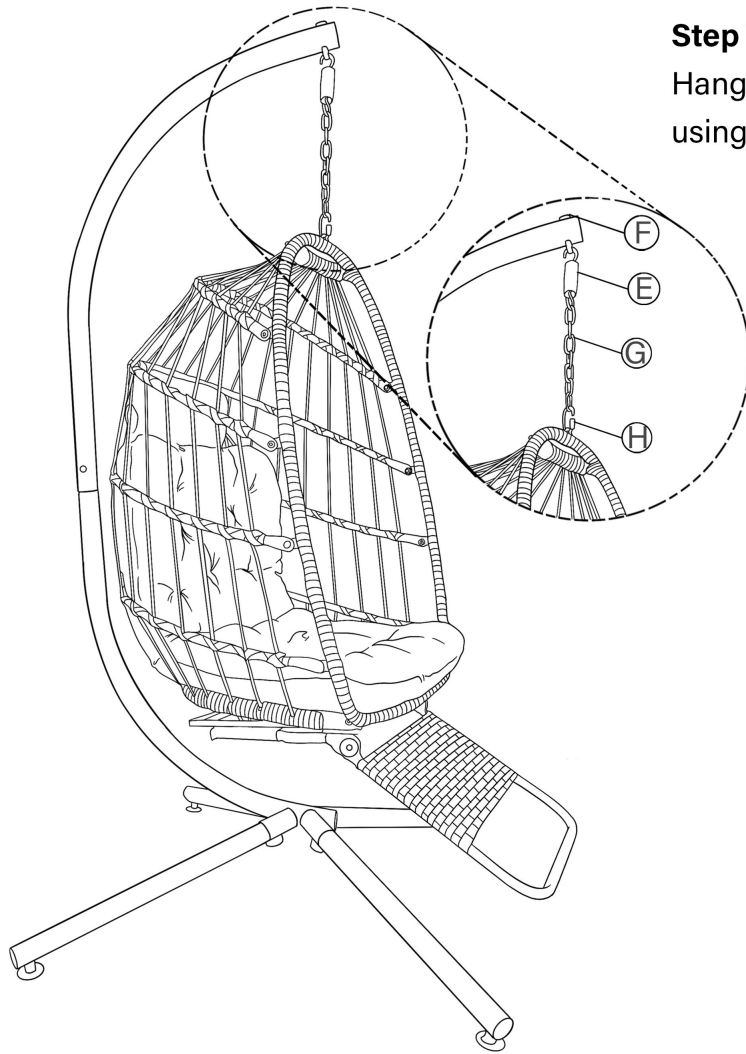

Step 7:

Hang part (D) onto part (B)
using parts (F, E, H,) and (G).

How to Reset the Footrest?

Lift the footrest to the highest gear to unlock it, then press it downward to reset it to the default 4-speed position.

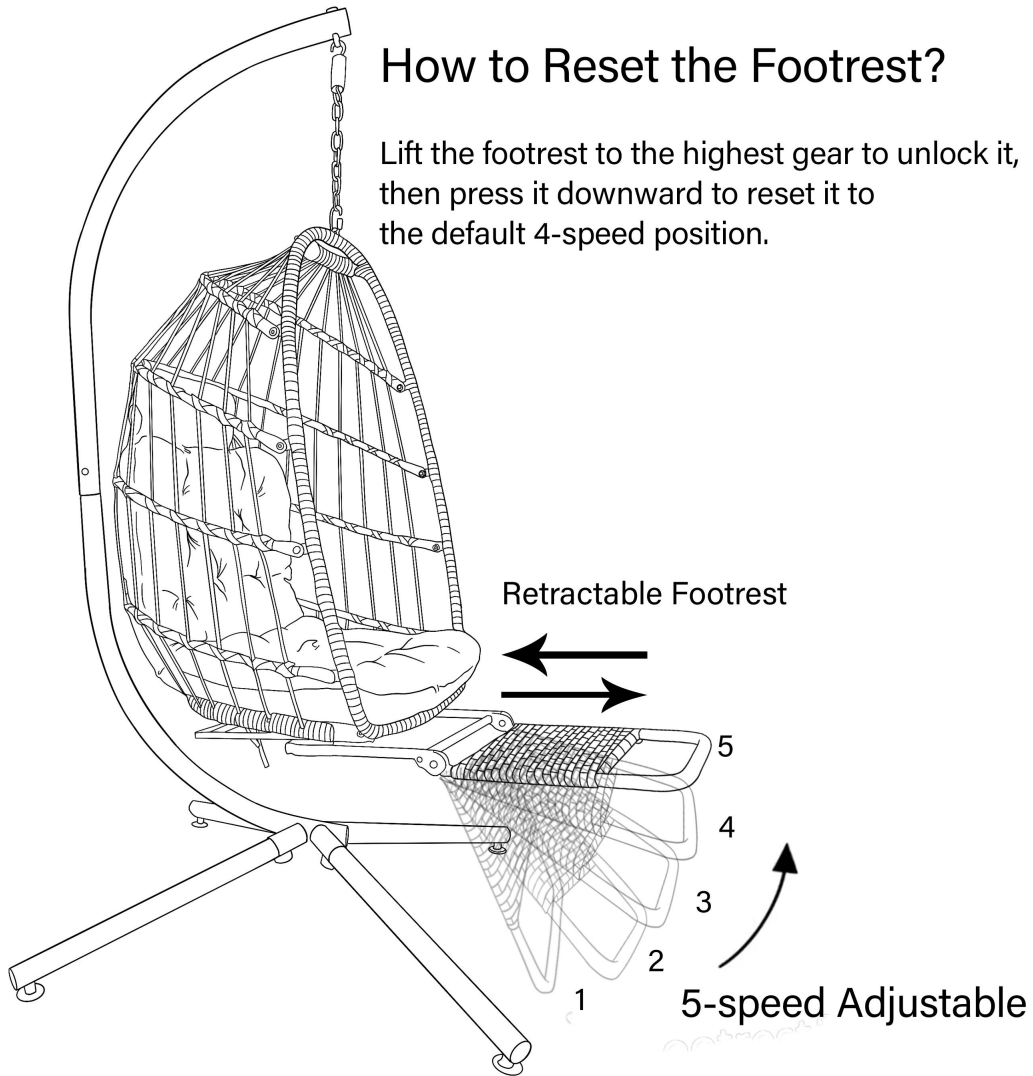

Swing Egg Chair

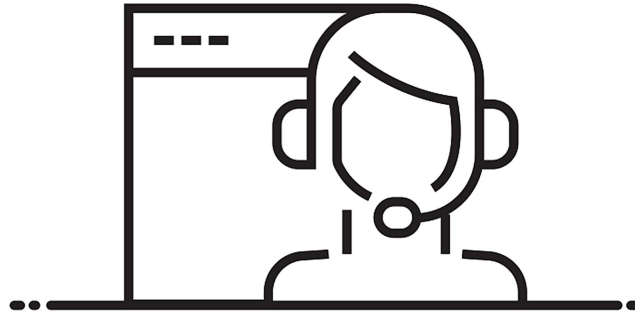

ONLINE SUPPORT

Please read the installation guide carefully before installation
If you have any questions during the installation process
you can contact us and we will provide you a detailed guidance

Online Support: kannel_service@outlook.com